



Dahua Network Video Recorder User's Manual

V 2.7.0

Table of Contents

1	Features and Specifications	1
1.1	Overview.....	1
1.2	Features.....	1
1.3	Specifications.....	2
1.3.1	NVR100/100-P Series	2
1.3.2	NVR11/11-P Series.....	4
1.3.3	NVR21-S2/NVR21-P-S2/NVR21-8P-S2 Series.....	7
1.3.4	NVR11H/11H-P Series	9
1.3.5	NVR11HS Series.....	12
1.3.6	NVR21HS-S2/21HS-P-S2/21HS-8P-S2 Series.....	13
1.3.7	NVR41HS-W-S2 Series.....	15
1.3.8	NVR41/41-P/41-8P/41-W Series	17
1.3.9	NVR41H/41H-P/41H-8P Series	18
1.3.10	NVR22-S2/22-P-S2/22-8P-S2 Series.....	20
1.3.11	NVR42N Series	22
1.3.12	NVR42/42-P/42-8P Series	24
1.3.13	NVR42-16P Series.....	25
1.3.14	NVR42-4K/42-8P-4K Series	27
1.3.15	NVR52-4KS2/52-8P-4KS2/52-16P-4KS2 Series	29
1.3.16	NVR44/44-8P/44-16P Series.....	31
1.3.17	NVR44-4K Series	33
1.3.18	NVR54-4KS2/54-16P-4KS2 Series	34
1.3.19	NVR48-4K Series	36
1.3.20	NVR58-4KS2/58-16P-4KS2 Series	38
1.3.21	NVR48/48-16P Series	39
1.3.22	NVR72/72-8P Series.....	41
1.3.23	NVR74/74-8P/74-16P Series.....	43
1.3.24	NVR78/78-16P/78-RH Series.....	45
1.3.25	NVR70/70-R Series.....	47
1.3.26	NVR42V-8P Series	48
1.3.27	NVR41-4KS2/41-P-4KS2/41-8P-4KS2 Series.....	50
1.3.28	NVR41HS-4KS2/ 41HS-P-4KS2/41HS-8P-4KS2 Series	52
1.3.29	NVR42-4KS2/42-P-4KS2/42-8P-4KS2/42-16P-4KS2 Series.....	54
1.3.30	NVR44-4KS2/44-16P-4KS2 Series	57
1.3.31	NVR48-4KS2/48-16P-4KS2.....	58
2	Front Panel and Rear Panel.....	61
2.1	Front Panel.....	61
2.1.1	NVR11/11-P/41/41-P/41-W/21-S2/21-P-S2/21-8P-S2/41-4KS2/41-P-4KS2/41-8P-4KS2 Series	61
2.1.2	NVR11H/11H-P/41H/41H-P/41H-8P Series.....	61
2.1.3	NVR11HS Series.....	62
2.1.4	NVR41HS-W-S2 Series.....	62

2.1.5	NVR41-8P Series	63
2.1.6	NVR42/42-P/42-8P/72/72-8P Series	64
2.1.7	NVR21HS-S2/21HS-P-S2/21HS-8P-S2 /41HS-4KS2/ 41HS-P-4KS2/41HS-8P-4KS2 Series 66	
2.1.8	NVR/22-S2/22-P-S2/22-8P-S2/42-16P/42N/42-4K/42-8P-4K/44-4K/48-4K/52-4KS2/52-8P-4KS2/52-16P-4KS2/54-4KS2/58-4KS2/42-4KS2/42-P-4KS2/42-8P-4KS2/42-16P-4KS2/ 44-4KS2/44-16P-4KS2/48-4KS2/48-16P-4KS2 Series	66
2.1.9	NVR44/44-8P/44-16P/74/74-8P/74-16P Series.....	67
2.1.10	NVR48/48-16P/78/78-16P Series	69
2.1.11	NVR78-RH Series	71
2.1.12	NVR70/70-R Series.....	73
2.1.13	NVR42V-8P Series.....	75
2.2	Rear Panel	76
2.2.1	NVR100/100-P Series	76
2.2.2	NVR11/11-P Series	77
2.2.3	NVR41/41-P/41-8P/41-W Series	78
2.2.4	NVR21-S2/21-P-S2/21-8P-S2 Series.....	80
2.2.5	NVR11H/11H-P/41H/41H-P/41H-8P Series	82
2.2.6	NVR11HS Series	83
2.2.7	NVR21HS-S2/21HS-P-S2/21HS-8P-S2 Series.....	84
2.2.8	NVR41HS-W-S2 Series.....	85
2.2.9	NVR22-S2/22-P-S2/22-8P-S2 Series.....	86
2.2.10	NVR42/42N/42-P/42-8P/42-16P Series.....	87
2.2.11	NVR42-4K/52-4KS2/52-8P-4KS2/52-16P-4KS2 Series.....	90
2.2.12	NVR42-8P-4K Series.....	91
2.2.13	NVR44/44-8P/44-16P Series.....	93
2.2.14	NVR44-4K/48-4K/54-4KS2/58-4KS2/54-16P-4KS2/58-16P-4KS2 Series	95
2.2.15	NVR48/48-16P Series	97
2.2.16	NVR72 Series	99
2.2.17	NVR72-8P Series	100
2.2.18	NVR74 Series	102
2.2.19	NVR74-8P/74-16P Series	104
2.2.20	NVR78 Series	106
2.2.21	NVR78-16P Series	108
2.2.22	NVR78-RH Series	110
2.2.23	NVR70 Series	111
2.2.24	NVR70-R Series	113
2.2.25	NVR42V-8P Series.....	115
2.2.26	NVR41-4KS2/41-P-4KS2/41-8P-4KS2	117
2.2.27	NVR41HS-4KS2/41HS-P-4KS2/41HS-8P-4KS2.....	118
2.2.28	NVR42-4KS2/42-P-4KS2/42-8P-4KS2/42-16P-4KS2	120
2.2.29	NVR44-4KS2/44-16P-4KS2.....	122
2.2.30	NVR48-4KS2/48-16P-4KS2.....	124
2.3	Alarm Connection.....	126
2.3.1	Alarm Port.....	126

2.3.2	Alarm input port	127
2.3.3	Alarm input and output port.....	127
2.3.4	Alarm relay specifications	128
2.4	Bidirectional talk	128
2.4.1	Device-end to PC-end	128
2.4.2	PC-end to the device-end	129
2.5	Mouse Operation.....	129
2.6	Remote Control	130
3	Device Installation	133
3.1	Check Unpacked NVR.....	133
3.2	About Front Panel and Rear Panel.....	133
3.3	HDD Installation.....	133
3.3.1	NVR100/100-P Series	133
3.3.2	NVR11/11-P/41/41-P/41-8P/41-W/21-S2/21-P-S2/21-8P-S2/41-4KS2/41-P-4KS2/41-8P-4KS2 Series.....	134
3.3.3	NVR11H/11H-P/41H/41H-P/41H-8P/11HS/21HS-S2/21HS-P-S2/21HS-8P-S2/41HS-W-S2/41HS-4KS2/ 41HS-P-4KS2/41HS-8P-4KS2 Series	135
3.3.4	NVR42/42N/42-P/42-8P/42-16P/72/72-8P/42-4K/42-8P-4K/52-4KS2/52-8P-4KS2/52-16P-4KS2/22-S2/22-P-S2/22-8P-S2/42-4KS2/42-P-4KS2/42-8P-4KS2/42-16P-4KS2 Series	136
3.3.5	NVR44/44-8P/44-16P/74/74-8P/74-16P/44-4K/54-4KS2/54-16P-4KS2/44-4KS2/44-16P-4KS2 Series.....	136
3.3.6	NVR48/48-16P/NVR78/78-16P/48-4K/58-4KS2/58-16P-4KS2/48-4KS2/48-16P-4KS2 Series	137
3.3.7	NVR78-RH Series	138
3.3.8	NVR70/70-R Series.....	139
3.3.9	NVR42V-8P Series	140
3.4	CD-ROM Installation.....	140
3.5	Connection Sample.....	142
3.5.1	NVR100/NVR100-P Series	142
3.5.2	NVR11/11-P/41/41-P/41-8P/41-W/21-S2/21-P-S2/21-8P-S2//41-4KS2/41-P-4KS2/41-8P-4KS2 Series	143
3.5.3	NVR11H/11H-P/41H/41H-P/41H-8P Series.....	143
3.5.4	NVR11HS//41HS-W-S2 Series	144
3.5.5	NVR41HS-W-S2 Series.....	145
3.5.6	NVR21HS-S2/21HS-P-S2/21HS-8P-S2/41HS-4KS2/41HS-P-4KS2/41HS-8P-4KS2 Series	146
3.5.7	NVR22-S2/22-P-S2/22-8P-S2 Series.....	147
3.5.8	NVR42N Series	148
3.5.9	NVR42/42-P/42-8P/42-16P/52-4KS2/52-8P-4KS2/52-16P-4KS2 Series.....	149

3.5.10	NVR42-4K/42-4KS2 Series.....	149
3.5.11	NVR42-8P-4K/42-P-4KS2/42-8P-4KS2/42-16P-4KS2 Series.....	150
3.5.12	NVR44-4K/48-4K/54-4KS2/54-16P-4KS2/58-4KS2/58-16P-4KS2 Series	151
3.5.13	NVR44/44-8P/44-16P/44-4KS2/44-16P-4KS2 Series	151
3.5.14	NVR48/48-16P/48-4KS2/48-16P-4KS2 Series.....	152
3.5.15	NVR72 Series	153
3.5.16	NVR72-8P Series	153
3.5.17	NVR74 Series	154
3.5.18	NVR74-8P/74-16P Series	155
3.5.19	NVR78 Series	156
3.5.20	NVR78-16P Series	157
3.5.21	NVR78-RH Series	158
3.5.22	NVR70 Series	159
3.5.23	NVR70-R Series	160
3.5.24	NVR42V-8P Series	161
4	Local Basic Operation	163
4.1	Boot up and Shutdown	163
4.1.1	Boot up.....	163
4.1.2	Shutdown.....	163
4.2	Change/Reset Password	163
4.2.1	Change Password.....	163
4.2.2	Reset Password.....	164
4.3	Startup Wizard.....	165
4.4	Navigation Bar	169
4.4.1	Main Menu.....	170
4.4.2	Dual-screen operation	170
4.4.3	Output Screen.....	170
4.4.4	Tour.....	170
4.4.5	PTZ.....	170
4.4.6	Color.....	170
4.4.7	Search.....	170
4.4.8	Alarm Status.....	170
4.4.9	Channel Info	171
4.4.10	Registration	171
4.4.11	Network.....	171
4.4.12	HDD Manager	171
4.4.13	USB Manager.....	171
4.5	Smart Add.....	171
4.6	Camera	175
4.6.1	Registration	175
4.6.2	Short-Cut Menu	177
4.6.3	Image	177
4.6.4	Channel Name.....	179
4.6.5	Upgrade	180
4.6.6	UPNP	180
4.6.7	Built-in Switch Setup.....	181

4.7	Preview	181
4.7.1	Preview	181
4.7.2	Preview control interface	182
4.7.3	Right Click Menu	183
4.7.4	Preview Display Effect Setup	184
4.7.4.1	Video Color	184
4.7.4.2	Display	186
4.7.4.3	TV adjust	187
4.7.5	Preview Tour Parameters	187
4.8	Fish eye (Optional)	188
4.8.1	Fish eye de-warp during preview interface	188
4.8.2	Fish eye de-warp during playback	191
4.9	PTZ	191
4.9.1	PTZ Settings	191
4.9.2	PTZ Control	192
4.9.2.1	PTZ Function Setup	194
4.9.2.2	Call PTZ Function	197
4.10	Record and Snapshot	198
4.10.1	Encode	198
4.10.1.1	Encode	198
4.10.1.2	Overlay	199
4.10.1.3	Snapshot	200
4.10.2	Schedule	201
4.10.2.1	Schedule Record	201
4.10.2.2	Schedule Snapshot	204
4.10.3	Motion detect record/snapshot	206
4.10.3.1	Motion detect record	206
4.10.3.2	Motion Detect Snapshot	208
4.10.4	Alarm Record/Snapshot	209
4.10.4.1	Alarm Record	209
4.10.4.2	Alarm Snapshot	210
4.10.5	Manual Record/Snapshot	211
4.10.5.1	Manual Record	211
4.10.5.2	Manual Snapshot	212
4.10.6	Holiday Record/Snapshot	212
4.10.6.1	Holiday Record	212
4.10.6.2	Holiday Snapshot	214
4.10.7	Other Record/Snapshot	214
4.11	Playback and Search	214
4.11.1	Real-time Playback	214
4.11.2	Search Interface	214
4.11.2.1	Smart Search	219
4.11.2.2	Accurate playback by time	219
4.11.2.3	Mark Playback	220
4.11.3	Picture Playback	221
4.12	Backup	222

4.12.1	File Backup.....	222
4.12.2	Import/Export.....	223
4.12.3	Backup Log.....	224
4.12.4	USB Device Auto Pop-up.....	225
4.13	Alarm.....	226
4.13.1	Detect Alarm.....	226
4.13.1.1	Motion Detect.....	226
4.13.1.2	Tampering.....	230
4.13.1.3	Video Loss.....	231
4.13.2	IVS (Optional).....	232
4.13.2.1	Tripwire (Optional)	232
4.13.2.2	Intrusion (Cross warning zone) (Optional)	236
4.13.2.3	Object Detect (Optional)	238
4.13.2.4	Scene Change (Optional)	239
4.13.3	Face Detect (Optional).....	240
4.13.4	Audio Detect (Optional)	240
4.13.5	Alarm output.....	241
4.13.6	Alarm Setup.....	242
4.13.7	Abnormality.....	247
4.14	Network.....	249
4.14.1.1	TCP/IP.....	249
4.14.1.2	Connection	251
4.14.1.3	WIFI AP.....	252
4.14.1.3.1	WIFI AP.....	252
4.14.1.3.2	Advanced	253
4.14.1.4	WIFI.....	254
4.14.1.5	3G	255
4.14.1.6	PPPoE.....	256
4.14.1.7	DDNS	257
4.14.1.8	UPnP.....	259
4.14.1.9	IP Filter.....	260
4.14.1.10	Email.....	262
4.14.1.11	FTP.....	263
4.14.1.12	SNMP	265
4.14.1.13	Multicast.....	265
4.14.1.14	Alarm Centre	267
4.14.1.15	Auto register	267
4.14.1.16	P2P	268
4.14.1.17	Easy Space.....	270
4.14.1.18	SWITCH.....	271
4.14.2	Network Test.....	271
4.14.2.1	Network Test.....	271
4.14.2.2	Network Load.....	272
4.15	HDD Setup	273
4.15.1	Format.....	273
4.15.2	HDD Information.....	274

4.15.3	Advanced.....	276
4.15.4	HDD Detect	278
4.15.4.1	Manual Detect.....	279
4.15.4.2	Detect Report.....	279
4.15.5	RAID Manager	281
4.15.5.1	RAID Config	281
4.15.5.2	Hotspare disks	282
4.16	Basic Setups	283
4.16.1	Device Setup.....	283
4.16.2	Data and Time	284
4.16.3	Holiday	285
4.17	Device Maintenance and Manager.....	285
4.17.1	System Info.....	285
4.17.1.1	Version	285
4.17.1.2	BPS	286
4.17.1.3	Online User	286
4.17.1.4	Remote Device Information	287
4.17.1.5	Remote.....	288
4.17.1.5.1	Device Status.....	288
4.17.1.5.2	Firmware	289
4.17.2	Log.....	290
4.17.3	Voice.....	291
4.17.3.1.1	File Manage	291
4.17.3.1.2	Schedule.....	292
4.17.4	Account	292
4.17.4.1.1	Add User	294
4.17.4.1.2	Modify user	296
4.17.4.1.3	Change Password	296
4.17.4.1.4	Add/Modify Group	296
4.17.4.1.5	Security Question.....	298
4.17.5	Update.....	298
4.17.5.1	Local Update	298
4.17.5.2	Uboot.....	299
4.17.6	Default.....	299
4.17.7	RS232	300
4.17.8	Auto Maintain	301
4.17.9	Logout /Shutdown/Restart.....	302
5	Web Operation.....	303
5.1	General Introduction	303
5.1.1	Preparation	303
5.1.2	Log in.....	304
5.2	LAN Mode.....	305
5.3	Real-time Monitor	307
5.4	PTZ.....	308
5.5	Image/Alarm-out.....	310
5.5.1	Image	310

5.5.2	Alarm output	310
5.6	Zero-channel Encode	310
5.7	WAN Login	311
5.8	Setup	312
5.8.1	Camera	312
5.8.1.1	Registration	312
5.8.1.2	Image	314
5.8.1.3	Encode	317
5.8.1.3.1	Encode	317
5.8.1.3.2	Snapshot	318
5.8.1.3.3	Video Overlay	319
5.8.1.3.4	Path	319
5.8.1.4	Channel Name	320
5.8.1.5	IPC Upgrade	320
5.8.2	Network	321
5.8.2.1	TCP/IP	321
5.8.2.2	Connection	322
5.8.2.3	WIFI AP	323
5.8.2.3.1	General Setup	323
5.8.2.3.2	Advanced	323
5.8.2.4	WIFI	324
5.8.2.5	3G	325
5.8.2.5.1	CDMA/GPRS	325
5.8.2.5.2	Mobile	326
5.8.2.6	PPPoE	327
5.8.2.7	DDNS	327
5.8.2.8	IP filter	328
5.8.2.9	Email	329
5.8.2.10	UPnP	330
5.8.2.11	SNMP	331
5.8.2.12	Multicast	332
5.8.2.13	Auto Register	333
5.8.2.14	Alarm Centre	333
5.8.2.15	HTTPS	334
5.8.2.15.1	Create Server Certificate	334
5.8.2.15.2	Download root certificate	335
5.8.2.15.3	View and set HTTPS port	338
5.8.2.15.4	Login	338
5.8.2.16	P2P	338
5.8.3	Event	339
5.8.3.1	Video detect	339
5.8.3.1.1	Motion Detect	339
5.8.3.1.2	Video Loss	343
5.8.3.1.3	Tampering	344
5.8.3.2	IVS (Optional)	344
5.8.3.2.1	Tripwire	344

5.8.3.2.2	Intrusion (Cross warning zone)	346
5.8.3.2.3	Object Detect	348
5.8.3.2.4	Change Scene	349
5.8.3.3	Face Detect (Optional)	350
5.8.3.4	Audio Detect (Optional)	351
5.8.3.5	Alarm	351
5.8.3.5.1	Local Alarm	351
5.8.3.5.2	Net Alarm	354
5.8.3.5.3	IPC external alarm	354
5.8.3.5.4	IPC Offline Alarm	355
5.8.3.6	Abnormality	356
5.8.4	Storage	358
5.8.4.1	Schedule	358
5.8.4.2	HDD Manager	360
5.8.4.2.1	Local Storage	360
5.8.4.2.2	HDD	360
5.8.4.2.3	FTP	360
5.8.4.3	Record Control	361
5.8.4.4	RAID Manager	362
5.8.4.4.1	RAID Config	362
5.8.4.4.2	Hotspare disks	362
5.8.4.5	Storage	363
5.8.4.5.1	Main Stream	363
5.8.4.5.2	Sub Stream	363
5.8.4.5.3	Snapshot	364
5.8.5	Setting	364
5.8.5.1	General	364
5.8.5.1.1	General	364
5.8.5.1.2	Date and time	365
5.8.5.1.3	Holiday Setup	366
5.8.5.2	Account	366
5.8.5.2.1	User name	367
5.8.5.2.2	Group	368
5.8.5.3	Display	370
5.8.5.3.1	Display	370
5.8.5.3.2	Tour	371
5.8.5.4	Alarm Out	371
5.8.5.5	Default	372
5.8.5.6	Import/Export	372
5.8.5.7	Auto maintain	373
5.8.5.8	Upgrade	373
5.8.5.9	RS232	374
5.8.5.10	PTZ	374
5.9	Information	376
5.9.1	Version	376
5.9.2	Log	376

5.9.3	Online User.....	377
5.10	Playback	377
5.10.1	Search Record.....	378
5.10.2	File List.....	378
5.10.3	Playback	379
5.10.4	Download.....	380
5.10.5	Load more.....	380
5.10.5.1	Download By File	380
5.10.5.2	Download by Time.....	381
5.10.5.3	Watermark.....	382
5.11	Alarm.....	382
5.12	Log out.....	383
5.13	Un-install Web Control.....	384
6	Glossary.....	385
7	FAQ	386
8	Appendix A HDD Capacity Calculation	391
9	Appendix B Compatible Network Camera List.....	392



Welcome

Thank you for purchasing our network video recorder!

This user's manual is designed to be a reference tool for your system.

Please open the accessory bag to check the items one by one in accordance with the list below.

Contact your local retailer ASAP if something is missing or damaged in the bag.

Important Safeguards and Warnings

1 . Electrical safety

All installation and operation here should conform to your local electrical safety codes.

The product must be grounded to reduce the risk of electric shock.

We assume no liability or responsibility for all the fires or electric shock caused by improper handling or installation.

2 . Transportation security

Heavy stress, violent vibration or water splash are not allowed during transportation, storage and installation.

3 . Installation

Keep upwards. Handle with care.

Do not apply power to the NVR before completing installation.

Do not place objects on the NVR.

4 . Qualified engineers needed

All the examination and repair work should be done by the qualified service engineers.

We are not liable for any problems caused by unauthorized modifications or attempted repair.

5 . Environment

The NVR should be installed in a cool, dry place away from direct sunlight, inflammable, explosive substances and etc.

This series product shall be transported, storage and used in the specified environments.

Environment which needs to comply with the following conditions:

- The function of the ITE being investigated to IEC 60950-1 is considered not likely to require connection to an Ethernet network with outside plant routing, including campus environment.
- The installation instructions clearly state that the ITE is to be connected only to PoE networks without routing to the outside plant.

6. Accessories

Be sure to use all the accessories recommended by manufacturer.

Before installation, please open the package and check all the components are included.

Contact your local retailer ASAP if something is broken in your package.

7. Lithium battery

Improper battery use may result in fire, explosion, or personal injury!

When replace the battery, please make sure you are using the same model!

CAUTION

RISK OF EXPLOSION IF BATTERY IS REPLACED BY AN INCORRECT TYPE.

DISPOSE OF USED BATTERIES ACCORDING TO THE INSTRUCTIONS.

Before your operation please read the following instructions carefully.

- **Installation environment**



- ✧ Keep away from extreme hot places and sources;
- ✧ Avoid direct sunlight;
- ✧ Keep away from extreme humid places;
- ✧ Avoid violent vibration;
- ✧ Do not put other devices on the top of the NVR;
- ✧ Be installed in well ventilated place; do not block the vent.

● Accessories

Check the following accessories after opening the box:

- Please refer to the packing list in the box *

Standards Approvals

For our Wi-Fi series product such as NVR41HS-W-S2, please refer to the following important notices.

This device complies with Part 15 of the FCC Rules.

Operation is subject to the following two conditions:

- (1) This device may not cause harmful interference, and
- (2) This device must accept any interference received, including interference that may cause undesired operation.

CAUTION: Changes or modifications not expressly approved by the party responsible for compliance could void the user's authority to operate the equipment.

NOTE: This equipment has been tested and found to comply with the limits for a Class B digital device, pursuant to Part 15 of the FCC Rules. These limits are designed to provide reasonable protection against harmful interference in a residential installation.

This equipment generates, uses and can radiate radio frequency energy and, if not installed and used in accordance with the instructions, may cause harmful interference to radio communications.

However, there is no guarantee that interference will not occur in a particular installation. If this equipment does cause harmful interference to radio or television reception, which can be determined by turning the equipment off and on, the user is encouraged to try to correct the interference by one or more of the following measures:

- Reorient or relocate the receiving antenna.
- Increase the separation between the equipment and receiver.
- Connect the equipment into an outlet on a circuit different from that to which the receiver is connected.
- Consult the dealer or an experienced radio/TV technician for help.

RF exposure warning

This equipment must be installed and operated in accordance with provided instructions and the antenna(s) used for this transmitter must be installed to provide a separation distance of at least



20 cm from all persons and must not be co-located or operating in conjunction with any other antenna or transmitter. End-users and installers must be provided with antenna installation instructions and transmitter operating conditions for satisfying RF exposure compliance.

IEEE 802.11b, 802.11g or 802.11n (20MHz) operation of this product in the U.S.A. is firmware-limited to channels 1 through 11. IEEE 802.11n (40MHz) operation of this product in the U.S.A. is firmware-limited to channels 3 through 9.

1 Features and Specifications

1.1 Overview

This series NVR is a high performance network video recorder. This series product support local preview, multiple-window display, recorded file local storage, remote control and mouse shortcut menu operation, and remote management and control function.

This series product supports centre storage, front-end storage and client-end storage. The monitor zone in the front-end can be set in anywhere. Working with other front-end devices such as IPC, NVS, this series product can establish a strong surveillance network via the CMS. In the network system, there is only one network cable from the monitor centre to the monitor zone in the whole network. There is no audio/video cable from the monitor centre to the monitor zone. The whole project is featuring of simple connection, low-cost, low maintenance work.

This series NVR can be widely used in many areas such as public security, water conservancy, transportation and education.

1.2 Features

Real-time Surveillance	<ul style="list-style-type: none"> • VGA, HDMI port. Connect to monitor to realize real-time surveillance. Some series support TV/VGA/HDMI output at the same time. • Short-cut menu when preview. • Support popular PTZ decoder control protocols. Support preset, tour and pattern.
Playback	<ul style="list-style-type: none"> • Support each channel real-time record independently, and at the same time it can support search, forward play, network monitor, record search, download and etc. • Support various playback modes: slow play, fast play, backward play and frame by frame play. • Support time title overlay so that you can view event accurate occurred time • Support specified zone enlargement.
User Management	<ul style="list-style-type: none"> • Each group has different management powers that can be edited freely. Every user belongs to an exclusive group.
Storage	<ul style="list-style-type: none"> • Via corresponding setup (such as alarm setup and schedule setup), you can backup related audio/video data in the network video recorder. • Support Web record and record local video and storage the file in the client end.
Alarm	<ul style="list-style-type: none"> • Respond to external alarm simultaneously (within 200MS), based on user's pre-defined relay setup, system can process the alarm input correctly and prompt user by screen and voice (support pre-recorded audio). • Support central alarm server setup, so that alarm information can remotely notify user automatically. Alarm input can be derived from various connected peripheral devices. • Alert you via email/sms.

Network Monitor	<ul style="list-style-type: none"> • Through network, sending audio/video data compressed by IPC or NVS to client-ends, then the data will be decompressed and display. • Support max 128 connections at the same time. • Transmit audio/video data by HTTP, TCP, UDP, MULTICAST, RTP/RTCP and etc. • Transmit some alarm data or alarm info by SNMP. • Support WEB access in WAN/LAN.
Window Split	<ul style="list-style-type: none"> • Adopt the video compression and digital process to show several windows in one monitor. Support 1/4/8/9/16/ 25/36-window display when preview and 1/4/9/16-window display when playback.
Record	<ul style="list-style-type: none"> • Support normal/motion detect/alarm record function. Save the recorded files in the HDD, USB device, client-end PC, or network storage server. You can search or playback the saved files at the local-end or via the Web/USB device.
Backup	<ul style="list-style-type: none"> • Support network backup, USB2.0 record backup function, the recorded files can be saved in network storage server, peripheral USB2.0 device, burner and etc.
Network Management	<ul style="list-style-type: none"> • Supervise NVR configuration and control power via Ethernet. • Support management via WEB.
Peripheral Equipment Management	<ul style="list-style-type: none"> • Support peripheral equipment management such as protocol setup and port connection. • Support transparent data transmission such as RS232 (RS-422), RS485 (RS-485).
Auxiliary	<ul style="list-style-type: none"> • Support switch between NTSC and PAL. • Support real-time system resources information and running statistics display. • Support log file. • Local GUI output. Shortcut menu operation via mouse. • IR control function (For some series product only.). Shortcut menu operation via remote control. • Support IPC or NVS remote video preview and control.

1.3 Specifications

1.3.1 NVR100/100-P Series

Model		100 Series	100-P Series
System	System Resources	4/8-ch series product support 4/8 HD connection respectively. Total bandwidth supports 28/56Mbps respectively.	
	OS	Embedded Linux real-time operation system	
	Operation Interface	WEB/Local GUI	
Decode	Video Decode	H.264/MJPEG	

Model		100 Series	100-P Series
	Type		
	Decode Capability	Max 2-ch 1080P 30fps or 4-ch 720P 30fps or 8-ch D1 30fps	
Video	Video Input	4/8-ch network compression video input	
	Video Output	1-channel VGA analog video output	
	HDMI	1-ch HDMI output. Version number is 1.4	
	Window Split	1/4/8-window	
Audio	Audio Input	N/A	
	Audio Output	N/A	
	Audio Compression Standard	G.711a	
Alarm	Alarm Input	N/A	
	Alarm Output	N/A	
Function	Storage	1 built-in 2.5-inch SATA port	
	Multiple-Channel Playback	Max 8-channel D1 or 4-channel 720P or 2-channel 1080P playback	
Port and Indicator	RS232 Port	N/A	
	RS485 Port	N/A	
	USB Port	2 peripheral USB2.0 ports.	

Model		100 Series	100-P Series
	Network Connection	1 RJ45 10/100Mbps self-adaptive Ethernet port.	
	PoE	N/A	4
	Power Port	1 power socket. Power adapter power supplying mode. DC 5V 2A power.	1 power socket. Power adapter power supplying mode. DC 48V 1.25A power.
	Power Button	N/A	
	Power On-off Button	N/A	
	IR Receiver Window	N/A	
	Clock	Built-in clock.	
	Indicator Light	N/A	
General	Power Consumption	<10W (No HDD)	
	Working Temperature	- 10°C ~ + 55°C	
	Working Humidity	10%~90%	
	Air pressure	86kPa~106kPa	
	Dimension	191.8mm×128.2mm×35.8mm	
	Weight	0.32kg~0.36kg (No HDD)	
	Installation Mode	Desk installation	

1.3.2 NVR11/11-P Series

Model	11 Series	11-P Series
-------	-----------	-------------

Model		11 Series	11-P Series
System	System Resources	4/8-ch series product support 4/8 HD connection respectively. Total bandwidth supports 28/56Mbps respectively.	
	OS	Embedded Linux real-time operation system	
	Operation Interface	WEB/Local GUI	
Decode	Video Decode Type	H.264/MJPEG	
	Decode Capability	Max 2-ch 1080P 30fps or 4-ch 720P 30fps or 8-ch D1 30fps	
Video	Video Input	4/8-ch network compression video input	
	Video Output	1-channel VGA analog video output	
	HDMI	1-ch HDMI output. Version number is 1.4	
	Window Split	1/4/8-window	
Audio	Audio Input	1-ch bidirectional talk input	
	Audio Output	1-ch bidirectional talk output	
	Audio Compression Standard	G.711a	
Alarm	Alarm Input	N/A	
	Alarm Output	N/A	
Function	Storage	1 built-in SATA port	

Model		11 Series	11-P Series
	Multiple-Channel Playback	Max 8-channel D1 or 4-channel 720P or 2-channel 1080P playback	
Port and Indicator	RS232 Port	N/A	
	RS485 Port	N/A	
	USB Port	2 peripheral USB2.0 ports.	
	Network Connection	1 RJ45 10/100Mbps self-adaptive Ethernet port.	
	PoE	N/A	4
	Power Port	1 power socket. Power adapter power supplying mode. DC 12V power.	1 power socket. Power adapter power supplying mode. DC 48V power.
	Power Button	N/A	
	Power On-off Button	N/A	
	IR Receiver Window	N/A	
	Clock	Built-in clock.	
	Indicator Light	One power status indicator light. One network status indicator light. One HDD status indicator light.	
General	Power Consumption	<10W (No HDD)	
	Working Temperature	- 10°C ~ + 55°C	
	Working Humidity	10%~90%	
	Air pressure	86kPa~106kPa	

Model		11 Series	11-P Series
	Dimension	205mm×206.75mm×45.2mm	
	Weight	0.5kg~1kg (No HDD)	
	Installation Mode	Desk installation	

1.3.3 NVR21-S2/NVR21-P-S2/NVR21-8P-S2 Series

Model		21-S2 Series	21-P-S2 Series	21-8P-S2 Series
System	System Resources	4/8/16-ch series product support 4/8/16 HD connection respectively. Total bandwidth supports 80Mbps.	4/8-ch series product support 4/8 HD connection respectively. Total bandwidth supports 80Mbps.	
	OS	Embedded Linux real-time operation system		
	Operation Interface	WEB/Local GUI		
Decode	Video Decode Type	H.264		
	Decode Capability	Max 4-ch 1080P 30fps or 8-ch 720P 30fps or 16-ch D1 30fps		
Video	Video Input	4/8/16-ch network compression video input	4/8-ch network compression video input	
	Video Output	1-channel VGA analog video output		
	HDMI	1-ch HDMI output. Version number is 1.4		
	Window Split	1/4/8/9/16-window	1/4/8/9-window	

Model		21-S2 Series	21-P-S2 Series	21-8P-S2 Series
Audio	Audio Input	1-ch bidirectional talk input		
	Audio Output	1-ch bidirectional talk output		
	Audio Compression Standard	G.711a		
Alarm	Alarm Input	N/A		
	Alarm Output	N/A		
Function	Storage	1 built-in SATA port		
	Multiple-Channel Playback	Max 16-channel D1 or 8-channel 720P or 4-channel 1080P playback		
Port and Indicator	RS232 Port	N/A		
	RS485 Port	N/A		
	USB Port	2 peripheral USB2.0 ports.		
	Network Connection	1 RJ45 10/100Mbps self-adaptive Ethernet port.		
	PoE	N/A	4	8
	Power Port	1 power socket. Power adapter power supplying mode. DC 12V power.	1 power socket. Power adapter power supplying mode. DC 48V power.	1 power socket. Power adapter power supplying mode. DC 48V power.
	Power Button	N/A		

Model		21-S2 Series	21-P-S2 Series	21-8P-S2 Series
	Power On-off Button	N/A		
	IR Receiver Window	N/A		
	Clock	Built-in clock.		
	Indicator Light	One power status indicator light. One network status indicator light. One HDD status indicator light.		
General	Power Consumption	<10W (No HDD)		
	Working Temperature	- 10°C ~ + 55°C		
	Working Humidity	10%~90%		
	Air pressure	86kPa~106kPa		
	Dimension	205mm×206.75mm×45.2mm	205mm×206.75mm×45.2mm	425mm×95mm×260mm
	Weight	0.5kg~2kg (No HDD)		
	Installation Mode	Desk installation		

1.3.4 NVR11H/11H-P Series

Model		11H Series	11H-P Series
System	System Resources	4/8-ch series product support 4/8 HD connection respectively. Total bandwidth supports 28/56Mbps respectively.	
	OS	Embedded Linux real-time operation system	
	Operation Interface	WEB/Local GUI	

Model		11H Series	11H-P Series
Decode	Video Decode Type	H.264/MJPEG	
	Decode Capability	Max 2-ch 1080P 30fps or 4-ch 720P 30fps or 8-ch D1 30fps	
Video	Video Input	4/8-ch network compression video input	
	Video Output	1-channel VGA analog video output	
	HDMI	1-ch HDMI output. Version number is 1.4	
	Window Split	1/4/8-window	
Audio	Audio Input	1-ch bidirectional talk input	
	Audio Output	1-ch bidirectional talk output	
	Audio Compression Standard	G.711a	
Alarm	Alarm Input	N/A	
	Alarm Output	N/A	
Function	Storage	1 built-in SATA port	
	Multiple-Channel Playback	Max 8-channel D1 or 4-channel 720P or 2-channel 1080P playback	
Port and Indicator	RS232 Port	N/A	
	RS485 Port	N/A	

Model		11H Series	11H-P Series
	USB Port	2 peripheral USB2.0 ports.	
	Network Connection	1 RJ45 10/100Mbps self-adaptive Ethernet port.	
	PoE	N/A	4
	Power Port	1 power socket. Power adapter power supplying mode. DC 12V power.	1 power socket. Power adapter power supplying mode. DC 48V power.
	Power Button	N/A	
	Power On-off Button	N/A	
	IR Receiver Window	N/A	
	Clock	Built-in clock.	
	Indicator Light	One power status indicator light. One network status indicator light. One HDD status indicator light.	
	General	Power Consumption	<10W (No HDD)
	Working Temperature	- 10°C ~ + 55°C	
	Working Humidity	10%~90%	
	Air pressure	86kPa~106kPa	
	Dimension	325mmx250.58mmx51mm	
	Weight	0.5kg~1kg (No HDD)	
	Installation Mode	Desk installation	

1.3.5 NVR11HS Series

Model		11HS Series
System	System Resources	4/8-ch series product support 4/8 HD connection respectively. Total bandwidth supports 25/56Mbps respectively.
	OS	Embedded Linux real-time operation system
	Operation Interface	WEB/Local GUI
Decode	Video Decode Type	H.264
	Decode Capability	<ul style="list-style-type: none"> ● For 8-channel series product: Max 2-ch 1080P 30fps or 4-ch 720P 30fs or 8-ch D1 30fps. ● For 4-channel series product: Max 1-ch 1080P 30fps or 4-ch 720P 30fs or 4-ch D1 30fps.
Video	Video Input	4/8-ch network compression video input
	Video Output	1-channel VGA analog video output
	HDMI	1-ch HDMI output. Version number is 1.4
	Window Split	1/4/8-window
Audio	Audio Input	N/A
	Audio Output	N/A
	Audio Compression Standard	G.711a
Alarm	Alarm Input	N/A
	Alarm Output	N/A
Function	Storage	1 built-in SATA port
	Multiple-Channel Playback	<ul style="list-style-type: none"> ● For 8-channel series product: Max 2-ch 1080P 30fps or 4-ch 720P 30fs or 8-channel D1 30fs playback. ● For 4-channel series product: Max 1-ch 1080P 30fps or 4-ch 720P 30fs or 4-ch D1 30fs playback.
Port and Indicator	RS232 Port	N/A
	RS485 Port	N/A
	USB Port	2 peripheral USB2.0 ports. One at the front panel and one at the rear panel.

Model		11HS Series
	Network Connection	1 RJ45 10/100Mbps self-adaptive Ethernet port.
	PoE Port	N/A
	Power Port	1 power socket. Power adapter power supplying mode. DC 12V/1.5A power.
	Power Button	N/A
	Power On-off Button	N/A
	IR Receiver Window	N/A
	Clock	Built-in clock.
	Indicator Light	One power status indicator light. One network status indicator light. One HDD status indicator light.
General	Power Consumption	<10W (No HDD)
	Working Temperature	- 10°C ~ + 55°C
	Working Humidity	10%~90%
	Air pressure	86kPa~106kPa
	Dimension(W*D*H)	260mmx220mmx44mm
	Weight	0.7kg~0.8kg (No HDD)
	Installation Mode	Desk installation

1.3.6 NVR21HS-S2/21HS-P-S2/21HS-8P-S2 Series

Model		NVR21HS-S2 Series	NVR21HS-P-S2 Series	NVR21HS-8P-S2 Series
System	System Resources	4/8/16-ch series product support 4/8/16 HD connection respectively. Total bandwidth supports 80Mbps.	4/8-ch series product support 4/8 HD connection respectively. Total bandwidth supports 80Mbps.	
	OS	Embedded Linux real-time operation system		
	Operation	WEB/Local GUI		

Model		NVR21HS-S2 Series	NVR21HS-P-S2 Series	NVR21HS-8P-S2 Series	
	Interface				
Decode	Video Decode Type	H.264			
	Decode Capability	Max 4-ch 1080P 30fps or 8-ch 720P 30fs or 16-ch D1 30fps			
Video	Video Input	4/8/16-ch network compression video input	4/8-ch network compression video input		
	Video Output	1-channel VGA analog video output			
	HDMI	1-ch HDMI output. Version number is 1.4			
	Window Split	1/4/8/9/16-window	1/4/8/9-window		
Audio	Audio Input	1-ch bidirectional talk input			
	Audio Output	1-ch bidirectional talk output			
	Audio Compression Standard	G.711a			
Alarm	Alarm Input	N/A			
	Alarm Output	N/A			
Function	Storage	1 built-in SATA port			
	Multiple-Channel Playback	Max 4-channel 1080P or 8-channel 720P or 16-channel D1 playback			
Port and Indicator	RS232 Port	N/A			
	RS485 Port	N/A			
	USB Port	2 peripheral USB2.0 ports.			
	Network Connection	1 RJ45 10/100Mbps self-adaptive Ethernet port.			
	PoE Port	N/A	4	8	
	Power Port	1 power socket. Power adapter power supplying mode. DC 12V power.	1 power socket. Power adapter power supplying mode. DC 48V power.	1 power socket. Power adapter power supplying mode. DC 48V power.	
	Power Button	N/A			

Model		NVR21HS-S2 Series	NVR21HS-P-S2 Series	NVR21HS-8P-S2 Series
	Power On-off Button	N/A		
	IR Receiver Window	N/A		
	Clock	Built-in clock.		
	Indicator Light	One power status indicator light. One network status indicator light. One HDD status indicator light.		
General	Power Consumption	<10W (No HDD)		
	Working Temperature	- 10°C ~ + 55°C		
	Working Humidity	10%~90%		
	Air pressure	86kPa~106kPa		
	Dimension(W×D×H)	260mm×220mm×44mm		
	Weight	0.7kg~0.8kg (No HDD)		
	Installation Mode	Desk installation		

1.3.7 NVR41HS-W-S2 Series

Model		41HS-W-S2 Series
System	System Resources	4/8-ch series product support 4/8 HD connection respectively. Total bandwidth supports 80Mbps.
	OS	Embedded Linux real-time operation system
	Operation Interface	WEB/Local GUI
Decode	Video Decode Type	H.264/MJPEG/MPEG4
	Decode Capability	Max 8-ch 1080P or 4-ch 3M or 2-ch 5M.
Video	Video Input	4/8-ch network compression video input
	Video Output	1-channel VGA analog video output
	HDMI	1-ch HDMI output. Version number is 1.4
	Window Split	1/4/8/9-window

Model		41HS-W-S2 Series
Audio	Audio Input	N/A
	Audio Output	N/A
	Audio Compression Standard	G.711a
Alarm	Alarm Input	N/A
	Alarm Output	N/A
Function	Storage	1 built-in SATA port
	Multiple-Channel Playback	Max 8-ch 1080P playback
Port and Indicator	RS232 Port	N/A
	RS485 Port	N/A
	USB Port	2 peripheral USB2.0 ports. One at the front panel and one at the rear panel.
	Network Connection	1 RJ45 10/100Mbps self-adaptive Ethernet port.
	PoE Port	N/A
	Power Port	1 power socket. Power adapter power supplying mode. DC 12V/2A power.
	Power Button	N/A
	Power On-off Button	N/A
	IR Receiver Window	N/A
	Clock	Built-in clock.
	Indicator Light	One power status indicator light. One network status indicator light. One HDD status indicator light.
General	Power Consumption	<30W (No HDD)
	Working Temperature	- 10°C ~ + 55°C
	Working Humidity	10%~90%
	Air pressure	86kPa~106kPa
	Dimension(W*D*H)	375mm×287mm×52mm

Model		41HS-W-S2 Series
	Weight	1.5kg~2.5kg(No HDD)
	Installation Mode	Desk installation

1.3.8 NVR41/41-P/41-8P/41-W Series

Model		41 Series	41-P Series	41-8P Series	41-W Series
System	System Resources	4/8/16-ch series product support 4/8/16 HD connection respectively. Total bandwidth supports 28/56/80Mbps respectively.			
	OS	Embedded Linux real-time operation system			
	Operation Interface	WEB/Local GUI			
Decode	Video Decode Type	H.264/MJPEG/MJPEG4			
	Decode Capability	Max 2-ch 5M 25fps or 4-ch 3M 25fps or 4-ch 1080P 30fps or 8-ch 720P 30fs			
Video	Video Input	4/8/16-ch network compression video input			
	Video Output	1-channel VGA analog video output			
	HDMI	1-ch HDMI output. Version number is 1.4			
	Window Split	1/4/8/9/16-window			1/4-window
Audio	Audio Input	1-ch bidirectional talk input			
	Audio Output	1-ch bidirectional talk output			
	Audio Compression Standard	G.711a			
Alarm	Alarm Input	N/A			
	Alarm Output	N/A			
Function	Storage	1 built-in SATA port			
	Multiple-Channel Playback	Max 4-channel 1080P playback			
	WIFI AP	N/A			Yes
Port and Indicator	RS232 Port	N/A			
	RS485 Port	N/A			

Model		41 Series	41-P Series	41-8P Series	41-W Series
	USB Port	2 peripheral USB2.0 ports.			
	Network Connection	1 RJ45 10/100Mbps self-adaptive Ethernet port.			
	PoE Port	N/A	4	8	N/A
	Power Port	1 power socket. Power adapter power supplying mode. DC 12V power.	1 power socket. Power adapter power supplying mode. DC 48V power.		1 power socket. Power adapter power supplying mode. DC 12V power.
	Power Button	1 button			
	Power On-off Button	N/A			
	IR Receiver Window	N/A			
	Clock	Built-in clock.			
	Indicator Light	One power status indicator light. One network status indicator light. One HDD status indicator light.			
General	Power Consumption	<10W (No HDD)			
	Working Temperature	- 10°C ~ + 55°C			
	Working Humidity	10%~90%			
	Air pressure	86kPa~106kPa			
	Dimension	205mm×206.75mm×45.2mm		270mm×204mm×42mm	205mm×206.75mm×45.2mm
	Weight	0.5kg~1kg (No HDD)			
	Installation Mode	Desk installation			

1.3.9 NVR41H/41H-P/41H-8P Series

Model		41H Series	41H-P Series	41H-8P Series
System	System Resources	4/8/16-ch series product support 4/8/16 HD connection respectively. Total bandwidth supports 28/56/80Mbps respectively.		
	OS	Embedded Linux real-time operation system		
	Operation	WEB/Local GUI		

Model		41H Series	41H-P Series	41H-8P Series
	Interface			
Decode	Video Decode Type	H.264/MJPEG/MJPEG4		
	Decode Capability	Max 2-ch 5M 25fps or 4-ch 3M 25fps or 4-ch 1080P 30fps or 8-ch 720P 30fs		
Video	Video Input	4/8/16-ch network compression video input		
	Video Output	1-channel VGA analog video output		
	HDMI	1-ch HDMI output. Version number is 1.4		
	Window Split	1/4/8/9/16-window		
Audio	Audio Input	1-ch bidirectional talk input		
	Audio Output	1-ch bidirectional talk output		
	Audio Compression Standard	G.711a		
Alarm	Alarm Input	N/A		2-channel
	Alarm Output	N/A		2-channel
Function	Storage	1 built-in SATA port		
	Multiple-Channel Playback	Max 4-channel 1080P playback		
Port and Indicator	RS232 Port	N/A		
	RS485 Port	N/A		
	USB Port	2 peripheral USB2.0 ports.		
	Network Connection	1 RJ45 10/100Mbps self-adaptive Ethernet port.		
	PoE Port	N/A	4	8
	Power Port	1 power socket. Power adapter power supplying mode. DC 12V power.	1 power socket. Power adapter power supplying mode. DC 48V power.	
	Power Button	1 button		
	Power On-off Button	N/A		

Model		41H Series	41H-P Series	41H-8P Series
	IR Receiver Window	N/A		
	Clock	Built-in clock.		
	Indicator Light	One power status indicator light. One network status indicator light. One HDD status indicator light.		
General	Power Consumption	<10W (No HDD)		
	Working Temperature	- 10°C ~ + 55°C		
	Working Humidity	10%~90%		
	Air pressure	86kPa~106kPa		
	Dimension	325mm×250.58mm×51mm		
	Weight	0.5kg~1kg (No HDD)		
	Installation Mode	Desk installation		

1.3.10 NVR22-S2/22-P-S2/22-8P-S2 Series

Model		NVR22-S2 Series	NVR22-P-S2 Series	NVR22-8P-S2 Series
System	System Resources	4/8/16-ch series product support 4/8/16 HD connection respectively. Total bandwidth supports 80Mbps.	4/8-ch series product support 4/8 HD connection respectively. Total bandwidth supports 80Mbps.	
	OS	Embedded Linux real-time operation system		
	Operation Interface	WEB/Local GUI		
Decode	Video Decode Type	H.264		
	Decode Capability	Max 4-ch 1080P 30fps or 8-ch 720P 30fs or 16-ch D1 30fps		
Video	Video Input	4/8/16-ch network compression video input	4/8-ch network compression video input	

Model		NVR22-S2 Series	NVR22-P-S2 Series	NVR22-8P-S2 Series
	Video Output	1-channel VGA analog video output		
	HDMI	1-ch HDMI output. Version number is 1.4		
	Window Split	1/4/8/9/16-window	1/4/8/9-window	
Audio	Audio Input	1-ch bidirectional talk input		
	Audio Output	1-ch bidirectional talk output		
	Audio Compression Standard	G.711a		
Alarm	Alarm Input	N/A		
	Alarm Output	N/A		
Function	Storage	2 built-in SATA ports		
	Multiple-Channel Playback	Max 4-channel 1080P or 8-channel 720P or 16-channel D1 playback		
Port and Indicator	RS232 Port	N/A		
	RS485 Port	N/A		
	USB Port	2 peripheral USB2.0 ports.		
	Network Connection	1 RJ45 10/100Mbps self-adaptive Ethernet port.		
	PoE Port	N/A	4	8
	Power Port	1 power socket. Power adapter power supplying mode. DC 12V power.	1 power socket. Power adapter power supplying mode. DC 48V power.	1 power socket. Power adapter power supplying mode. DC 48V power.
	Power Button	N/A		
	Power On-off Button	N/A		
	IR Receiver Window	N/A		
	Clock	Built-in clock.		
	Indicator Light	One power status indicator light. One network status indicator light. One HDD status indicator light.		

Model		NVR22-S2 Series	NVR22-P-S2 Series	NVR22-8P-S2 Series
General	Power Consumption	<10W (No HDD)		
	Working Temperature	- 10℃ ~ + 55℃		
	Working Humidity	10%~90%		
	Air pressure	86kPa~106kPa		
	Dimension(W×D×H)	375mm×287mm×52mm		
	Weight	1.5kg~2.5kg (No HDD)		
	Installation Mode	Desk installation		

1.3.11 NVR42N Series

Model		42N Series
System	System Resources	4/8/16/32-channel series product support 4/8/16/32-channel HD connection respectively. Main stream bandwidth supports 40/80/160/160Mbps respectively.
	Operation System	Embedded Linux real-time operation system
	Operation Interface	WEB/Local GUI
Decode	Video Compression	H.264/MJPEG/MPEG4
	Decode Capacity	Max supports 16-channel D1, or 8-channel 720P, or 4-channel 1080P, or 4*3M or 2*5M decode.
Video	Video Input	4/8/16/32-ch network compression video input
	Video Output	1-channel VGA analog video output.
	HDMI	1-ch HDMI output. Version number is 1.4
	Window Split	1/4/8/9/16-window
Audio	Audio Input	1-ch bidirectional talk input
	Audio Output	1-ch bidirectional talk output

	Audio Compression	G.711a
Alarm	Alarm Input	N/A
	Alarm Output	N/A
Function	Storage	2 built-in SATA ports.
	Multiple-channel Playback	Max 8-channel 720P/4-channel 1080P playback at the same time.
Port and Indicator	RS232 Port	One RS232 port to debug transparent COM data.
	RS485 port	One RS485 port to control PTZ. Support various protocols.
	USB2.0 Port	Three peripheral USB2.0 ports.
	Network Connection	1 RJ45 10/100/1000Mbps self-adaptive Ethernet port.
	Power Port	One power port, power adapter. Input DC 12V.
	Power Button	One button. At the rear panel.
	Power On-off Button	One button. At the front-panel.
	IR Receiver Window	Support IR remote control
	Clock	Built-in clock.
	Indicator Light	One power status indicator light. One network status indicator light. One HDD status indicator light.
General	Power Consumption	<30W(No HDD)
	Working Temperature	-10°C ~ +55°C
	Working Humidity	10%—90%
	Air	86kpa—106kpa

	pressure	
	Dimension	375mm×287mm×52mm
	Weight	1.5kg~2.5kg (No HDD)
	Installation	Desk installation

1.3.12 NVR42/42-P/42-8P Series

Model		42 Series	42-P Series	42-8P Series
System	System Resources	4/8/16/32-channel series product support 4/8/16/32-channel HD connection respectively. Main stream bandwidth supports 40/80/160/160Mbps respectively.		
	Operation System	Embedded Linux real-time operation system		
	Operation Interface	WEB/Local GUI		
Decode	Video Compression	H.264/MJPEG/MPEG4		
	Decode Capacity	Max supports 16-channel D1, or 8-channel 720P, or 4-channel 1080P, or 4*3M or 2*5M decode.		
Video	Video Input	4/8/16/32-ch network compression video input		
	Video Output	1-channel VGA analog video output.		
	HDMI	1-ch HDMI output. Version number is 1.4		
	Window Split	1/4/8/9/16-window		
Audio	Audio Input	1-ch bidirectional talk input		
	Audio Output	1-ch bidirectional talk output		
	Audio Compression	G.711a		
Alarm	Alarm Input	4-ch alarm input		
	Alarm Output	2-ch alarm output		
Function	Storage	2 built-in SATA ports.		
	Multiple-channel	Max 8-channel 720P/4-channel 1080P playback at the same time.		

	Playback			
Port and Indicator	RS232 Port	One RS232 port to debug transparent COM data.		
	RS485 port	One RS485 port to control PTZ. Support various protocols.		
	USB2.0 Port	Three peripheral USB2.0 ports.		
	Network Connection	1 RJ45 10/100/1000Mbps self-adaptive Ethernet port.		
	Power Port	One power port, power adapter. Input DC 12V.	Two power ports. Input DC 12V/DC 48V.	One power ports. Input 100-240V , 47~63Hz.
	Power Button	One button. At the rear panel.		
	Power On-off Button	One button. At the front-panel.		
	IR Receiver Window	Support IR remote control		
	Clock	Built-in clock.		
	Indicator Light	One power status indicator light. One network status indicator light. One HDD status indicator light.		
General	Power Consumption	<30W(No HDD)		
	Working Temperature	-10℃~+55℃		
	Working Humidity	10%—90%		
	Air pressure	86kpa—106kpa		
	Dimension	375mm×287mm×52mm	375mm×287mm×52mm	295mm×275mm×47mm
	Weight	1.5kg~2.5kg (No HDD)		
	Installation	Desk installation		

1.3.13 NVR42-16P Series

Model	42-16P Series
--------------	----------------------

System	System Resources	16/32-channel series product support 4/8/16/32-channel HD connection respectively. Main stream/sub stream bandwidth supports 200Mbps.
	Operation System	Embedded Linux real-time operation system
	Operation Interface	WEB/Local GUI
Decode	Video Compression	H.264/MJPEG/MPEG4
	Decode Capacity	Max supports 32-channel D1, or 16-channel 720P, or 8-channel 1080P, or 4*3M or 2*5M decode.
Video	Video Input	4/8/16/32-ch network compression video input
	Video Output	1-channel VGA analog video output.
	HDMI	1-ch HDMI output. Version number is 1.4
	Window Split	1/4/8/9/16-window
Audio	Audio Input	1-ch bidirectional talk input
	Audio Output	1-ch bidirectional talk output
	Audio Compression	G.711a
Alarm	Alarm Input	4-ch alarm input
	Alarm Output	2-ch alarm output
Function	Storage	2 built-in SATA ports.
	Multiple-channel Playback	Max 16-channel 720P/8-channel 1080P playback at the same time.
Port and Indicator	RS232 Port	One RS232 port to debug transparent COM data.
	RS485 port	One RS485 port to control PTZ. Support various protocols.
	USB2.0 Port	One peripheral USB2.0 port. One peripheral USB3.0 port.
	Network Connection	1 RJ45 10/100/1000Mbps self-adaptive Ethernet port.

	Power Port	One power ports. Input 100-240V, 47~63Hz.
	Power Button	One button. At the rear panel.
	Power On-off Button	N/A
	IR Receiver Window	N/A
	Clock	Built-in clock.
	Indicator Light	One power status indicator light. One network status indicator light. One HDD status indicator light.
General	Power Consumption	<30W(No HDD)
	Working Temperature	-10℃~+55℃
	Working Humidity	10%—90%
	Air pressure	86kpa—106kpa
	Dimension	375mm×287mm×52mm
	Weight	1.5kg~2.5kg (No HDD)
	Installation	Desk installation

1.3.14 NVR42-4K/42-8P-4K Series

Model		NVR42-4K Series	NVR42-8P-4K Series
System	System Resources	8/16/32-channel series product support 8/16/32-channel HD connection respectively. The main stream bandwidth supports 48/96/192Mbps.	
	Operation System	Embedded Linux real-time operation system	
	Operation Interface	WEB/Local GUI	
Decode	Video Compression	H.264/MJPEG/MPEG4	

	Decode Capacity	H.264: Max supports 16-channel D1, or 8-channel 720P, 4-channel 1080P or 1-channel 4K decode. H.265: Max supports 16-channel D1, or 8-channel 720P, 4-channel 1080P or 1-channel 4K decode.	
Video	Video Input	8/16/32-ch network compression video input	
	Video Output	1-channel VGA analog video output.	
	HDMI	1-ch HDMI output. Version number is 1.4	
	Window Split	1/4/8/9/16-window	
Audio	Audio Input	1-ch bidirectional talk input	
	Audio Output	1-ch bidirectional talk output	
	Audio Compression	G.711a, G.711u, PCM, G726	
Alarm	Alarm Input	8-ch alarm input	
	Alarm Output	3-ch alarm output Relay output. Relay (DC 30V /1A, AC 125V/0.5A (Activation output)) Including one controllable DC +12V output.	
Function	Storage	2 built-in SATA ports.	
	Multiple-channel Playback	Max 8-channel 720P/4-channel 1080P/1-channel 4K playback at the same time.	
Port and Indicator	RS232 Port	One RS232 port to debug transparent COM data.	
	RS485 port	One RS485 port to control PTZ. Support various protocols.	
	USB Port	2 peripheral USB ports: One USB2.0 at the front panel and one USB3.0 at the rear panel.	
	Network Connection	One RJ45 10/100/1000Mbps self-adaptive Ethernet port.	
	Power Port	One power socket. Power adapter power supplying. Input DC 12V power.	One power port. Input 100-240V, 47~63Hz.
	Power Button	One button. At the rear panel.	
	Power On-off Button	N/A	

	IR Receiver Window	N/A
	Clock	Built-in clock.
General	Indicator Light	One power status indicator light. One network status indicator light. One HDD status indicator light. One device running status indicator light.
	Power Consumption	<20W(No HDD)
	Working Temperature	-10℃~+55℃
	Working Humidity	10%—90%
	Air pressure	86kpa—106kpa
	Dimension	1U, 375mm(W) × 49.8mm(H) × 250mm(D)
	Weight	1.65kg (No HDD)
	Installation	Desk/rack installation

1.3.15 NVR52-4KS2/52-8P-4KS2/52-16P-4KS2 Series

Model		NVR52-4KS2/52-8P-4KS2/52-16P-4KS2 Series
System	System Resources	8/16/32/64-channel series product support 8/16/32/64-channel HD connection respectively. The main stream bandwidth supports 80/160/320/320Mbps.
	Operation System	Embedded Linux real-time operation system
	Operation Interface	WEB/Local GUI
Decode	Video Compression	MPEG4, MJPG, H.264, H.265
	Decode Capacity	H.264/H.265: Max supports 64-channel D1, or 32-channel 720P, 16-channel 1080P or 4-channel 4K decode.
Video	Video Input	8/16/32/64-ch network compression video input
	Video Output	1-channel VGA analog video output.
	HDMI	1-ch HDMI output. Version number is 1.4

	Window Split	1/4/8/9/16/25/36-window
Audio	Audio Input	1-ch bidirectional talk input
	Audio Output	1-ch bidirectional talk output
	Audio Compression	G.711a, G.711u, PCM, G726 (The bidirectional talk function supports G.711a, G.711u, PCM only.)
Alarm	Alarm Input	4-ch alarm input
	Alarm Output	3-ch relay output
Function	Storage	2 built-in SATA ports.
	Multiple-channel Playback	Max 64-channel D1/32-channel 720P/16-channel 1080P/4-channel 4K playback at the same time.
	Record Mode	Overwrite
	Backup Mode	Flash disk, DVD burner.
Port and Indicator	Network Protocol	IPv4/IPv6/HTTP/UPnP/NTP/SADP/SNMP/PPPoE/DNS/FTP/ONVIF(Version 2.4)/PSIA
	RS232 Port	One RS232 port to debug transparent COM data.
	RS485 port	One RS485 port to control PTZ. Support various protocols.
	USB Port	2 peripheral USB ports: One USB2.0 at the front panel and one USB3.0 at the rear panel.
	Network Connection	One RJ45 10/100/1000Mbps self-adaptive Ethernet port.
	Power Port	One power socket. Power adapter power supplying. Input DC 12V-4A power.
	Power Button	One button. At the rear panel.
	Power On-off Button	N/A
	IR Receiver Window	N/A

General	Indicator Light	One power status indicator light. One network status indicator light. One HDD status indicator light. One device running status indicator light.
	Power	DC 12V
	Power Consumption	General series: 9.5W(No HDD) 8 PoE series: 15.2W(No HDD) 16 PoE series: 14.5W(No HDD)
	Working Temperature	-10°C ~ +55°C
	Working Humidity	10%—90%
	Air pressure	86kpa—106kpa
	Dimension	General series: 375mm(W) × 56mm(H) × 281.4mm(D) PoE series: 375mm(W) × 53mm(H) × 327.3mm(D)
	Weight (No HDD)	General series: : 1.60Kg 8 PoE series: 2.60Kg 16 PoE series: 2.70Kg
	Installation	Desk/rack installation

1.3.16 NVR44/44-8P/44-16P Series

Model		NVR44 Series	NVR44-8P Series	NVR44-16P Series
System	System Resources	8/16/32-channel series product support 8/16/32-channel HD connection respectively. The main stream bandwidth supports 200Mbps.		
	Operation System	Embedded Linux real-time operation system		
	Operation Interface	WEB/Local GUI		
Decode	Video Compression	H.264/MJPEG/MPEG4		
	Decode Capacity	Max supports 16-channel D1, or 8-channel 720P, or 4-channel 3M or 2*5M decode.		
Video	Video Input	8/16/32-ch network compression video input		
	Video Output	1-channel VGA analog video output.		
	HDMI	1-ch HDMI output. Version number is 1.4		

	Window Split	1/4/8/9/16-window
Audio	Audio Input	1-ch bidirectional talk input
	Audio Output	1-ch bidirectional talk output
	Audio Compression	G.711a
Alarm	Alarm Input	16-ch alarm input
	Alarm Output	4-ch alarm output Relay output. Relay (DC 30V /1A, AC 125V/0.5A (Activation output)) Including one controllable DC +12V output.
Function	Storage	4 built-in SATA ports. 1 external eSATA port.
	Multiple-channel Playback	Max 8-channel 720P/4-channel 1080P playback at the same time.
Port and Indicator	RS232 Port	One RS232 port to debug transparent COM data.
	RS485 port	One RS485 port to control PTZ. Support various protocols.
	USB2.0 Port	2 peripheral USB2.0 ports. One at the front panel and one at the rear panel.
	Network Connection	One RJ45 10/100/1000Mbps self-adaptive Ethernet port.
	Power Port	One power port. Input 100-240V, 50~60Hz.
	Power Button	One button. At the rear panel.
	Power On-off Button	One button. At the front-panel.
	IR Receiver Window	Support IR remote control
	Clock	Built-in clock.
General	Indicator Light	One power status indicator light. One network status indicator light. One HDD status indicator light.
	Power Consump	<30W(No HDD)

	tion	
	Working Temperature	-10℃~+55℃
	Working Humidity	10%—90%
	Air pressure	86kpa—106kpa
	Dimension	1.5U, 440mm × 460mm × 68mm
	Weight	5kg~6kg (No HDD)
	Installation	Desk installation

1.3.17 NVR44-4K Series

Specifications		NVR44-4K
System	Main Processor	Industrial embedded micro processor
	Operation System	Embedded LINUX system
	System Resources	Max 8-channel×1080P connection,
	User Interface	WEB, local GUI
Audio Parameters	Audio Input	1-ch MIC bidirectional talk audio input
	Audio Output	1-ch MIC bidirectional talk audio output
	Audio Compression Standard	G.711a, G.711u, PCM, G726
Video Parameters	Video Input	8/16/32-ch network compression video input
	Video Output	1-channel VGA 2-channel HDMI.
	Video Compression Standard	H.264
	Window Split Mode	The 1st screen: 1/4/8/9/16-screen. The 2nd screen: 1/4-screen.
Alarm Parameters	Alarm Input	16-channel
	Alarm Output	8-channel relay output
Decode Parameters	Decode Type	MPEG4, H.264, H.265
	Decode Capability	16-channel×D1;8-channel×720P, 4-channel 1080P;1-channel 4K

Functions	Record Mode	Manual recording, motion detection recording, schedule recording and alarm recording. Priority: Manual recording>card number recording-> alarm recording>motion detection recording>schedule recording.
	Multi-Channel Playback	Max support 64M (H265&H264 1:1) playback at the same time.
	Motion Detect	Each screen supports 396/330((PAL 22x18, NTSC 22x15) detection zones. Various sensitivity levels.
	Privacy Mask	Each channel supports 4 privacy mask zones.
	Record Mode	Overwrite
	Backup Mode	Flash disk, eSATA, DVD burner.
Network Function	Network Protocol	IPv4/IPv6/HTTP/UPnP/NTP/SADP/SNMP/PPPoE/DNS/FTP/ONVIF/PSIA
	SATA Port	4 SATA Ports
	eSATA Port	1 eSATA port
	RS232 Port	1 RS232 port. To debug and transmit COM data.
	RS485 Port	1 RS485 port. To control peripheral PTZ and etc. Support various protocols.
	USB Port	1 USB 2.0 port at the front panel and 2 USB3.0 ports at the rear panel.
	HDMI Port	2 HDMI ports
	Network Port	2 RJ45 10/100/1000Mbps self-adaptive Ethernet ports+2 1000Mbps self-adaptive fiber ports
	Power On-off Button	One at the rear panel.
	Indicator Light	4 indicator lights. <ul style="list-style-type: none"> ● 1 system running status indicator light ● 1 HDD indicator light ● 1 network status indicator light ● 1 power status indicator light
General Parameters	Power	AC100~240V
	Power Consumption	General series: <17W (No HDD) , PoE series: <26.5W (No HDD) ,
	Working Temperature	0℃~50℃
	Working Humidity	10%~90% (No condensation)
	Dimensions (W×H×D)	440×76×405mm
	Weight	General series:4.35 kg (No HDD) , PoE series: 4.65kg (No HDD) ,
	Installation Mode	Rack/desktop

1.3.18 NVR54-4KS2/54-16P-4KS2 Series

Specifications		NVR54-4KS2/54-16P-4KS2 Series
System	Main Processor	Industrial embedded micro processor

	Operation System	Embedded LINUX system
	System Resources	8/16/32/64-channel main stream connection: max supports 80/160/320/320Mbps
	User Interface	WEB, local GUI
Audio Parameters	Audio Input	1-ch MIC bidirectional talk audio input
	Audio Output	1-ch MIC bidirectional talk audio output
	Audio Compression Standard	G.711a, G.711u, PCM, G726 (The bidirectional talk supports G.711a, G.711u, PCM only.)
Video Parameters	Video Input	8/16/32/64-ch network compression video input
	Video Output	1-channel VGA 2-channel HDMI.
	Video Compression Standard	H.264
	Window Split Mode	1/4/8/9/16/25/36/64-screen.
Alarm Parameters	Alarm Input	16-channel
	Alarm Output	6-channel relay output
Decode Parameters	Decode Type	MPEG4, MJPG, H.264, H.265
	Decode Capability	H.264/H.265: 64-channelxD1, 32-channelx720P, 16-channel 1080P; 4-channel 4K.
Functions	Record Mode	Manual recording, motion detection recording, schedule recording and alarm recording. Priority: Manual recording>card number recording-> alarm recording>motion detection recording>schedule recording.
	Multi-Channel Playback	Max support 16-channel 1080P playback at the same time.
	Motion Detect	Each screen supports 396/330((PAL 22x18, NTSC 22x15) detection zones. Various sensitivity levels.
	Privacy Mask	Each channel supports 4 privacy mask zones.
	Record Mode	Overwrite
	Backup Mode	Flash disk, eSATA, DVD burner.
Network Function	Network Protocol	IPv4/IPv6/HTTP/UPnP/NTP/SADP/SNMP/PPPoE/DNS/FTP/ONVIF(Version 2.4)/PSIA
	SATA Port	4 SATA Ports
	eSATA Port	1 eSATA port
	RS232 Port	1 RS232 port. To debug and transmit COM data.
	RS485 Port	1 RS485 port. To control peripheral PTZ and etc. Support various protocols.
	USB Port	1 USB 2.0 port at the front panel and 2 USB3.0 ports at the rear panel.

	HDMI Port	2 HDMI ports
	Network Port	2 RJ45 10/100/1000Mbps self-adaptive Ethernet ports
	Power Port	One power socket. Power adapter power supplying. Input AC 100V~240V, 50Hz~60Hz.
	Power On-off Button	One at the rear panel.
	Indicator Light	4 indicator lights. <ul style="list-style-type: none"> ● 1 system running status indicator light ● 1 HDD indicator light ● 1 network status indicator light ● 1 power status indicator light
General Parameters	Power	AC90~264V
	Power Consumption	General series: 16.7W (No HDD) 16 PoE series: 17.5W (No HDD)
	Working Temperature	-10°C~55°C
	Working Humidity	10%~90% (No condensation)
	Dimensions (W×H×D)	440×76×411mm
	Weight(No HDD)	General series:4.30Kg, PoE series: 4.65Kg,
	Installation Mode	Rack/desktop

1.3.19 NVR48-4K Series

Specifications		NVR48-4K
System	Main Processor	Industrial embedded micro processor
	Operation System	Embedded LINUX system
	System Resources	Max 8-channel×1080P connection,
	User Interface	WEB, local GUI
Audio Parameters	Audio Input	1-ch MIC bidirectional talk audio input
	Audio Output	1-ch MIC bidirectional talk audio output
	Audio Compression Standard	G.711a, G.711u, PCM, G726
Video Parameters	Video Input	8/16/32-ch network compression video input
	Video Output	1-channel VGA 2-channel HDMI.
	Video Compression Standard	H.264
	Window Split Mode	The 1st screen: 1/4/8/9/16-screen. The 2nd screen: 1/4-screen.

Alarm Parameters	Alarm Input	16-channel
	Alarm Output	6-channel relay output
Decode Parameters	Decode Type	MPEG4, H.264, H.265
	Decode Capability	16-channel×D1;8-channel×720P, 4-channel 1080P;1-channel 4K
Functions	Record Mode	Manual recording, motion detection recording, schedule recording and alarm recording. Priority: Manual recording>card number recording-> alarm recording>motion detection recording>schedule recording.
	Multi-Channel Playback	Max support 64M (H265&H264 1:1) playback at the same time.
	Motion Detect	Each screen supports 396/330((PAL 22×18, NTSC 22×15) detection zones. Various sensitivity levels.
	Privacy Mask	Each channel supports 4 privacy mask zones.
	Record Mode	Overwrite
	Backup Mode	Flash disk, eSATA, DVD burner.
Network Function	Network Protocol	IPv4/IPv6/HTTP/UPnP/NTP/SADP/SNMP/PPPoE/DNS/FTP/ONVIF/PSIA
	SATA Port	8 SATA Ports
	eSATA Port	1 eSATA port
	RS232 Port	1 RS232 port. To debug and transmit COM data.
	RS485 Port	1 RS485 port. To control peripheral PTZ and etc. Support various protocols.
	USB Port	2 USB 2.0 ports at the front panel and 2 USB3.0 ports at the rear panel.
	HDMI Port	2 HDMI ports
	Network Port	2 RJ45 10/100/1000Mbps self-adaptive Ethernet ports+2 1000Mbps self-adaptive fiber ports
	Power On-off Button	One at the rear panel.
	Indicator Light	4 indicator lights. <ul style="list-style-type: none"> ● 1 system running status indicator light ● 1 HDD indicator light ● 1 network status indicator light ● 1 power status indicator light
General Parameters	Power	AC100~240V
	Power Consumption	General series: <18.8W (No HDD) , PoE series: <27.9W (No HDD) ,
	Working Temperature	0℃~50℃
	Working Humidity	10%~90% (No condensation)
	Dimensions (W×H×D)	440×95×445mm

	Weight	General series:6.6 kg (No HDD) , PoE series: 6.75kg (No HDD) ,
	Installation Mode	Rack/desktop

1.3.20 NVR58-4KS2/58-16P-4KS2 Series

Specifications		NVR58-4KS2/58-16P-4KS2 Series
System	Main Processor	Industrial embedded micro processor
	Operation System	Embedded LINUX system
	System Resources	8/16/32/64-channel main stream max supports 80/160/320/320Mbps
	User Interface	WEB, local GUI
Audio Parameters	Audio Input	1-ch MIC bidirectional talk audio input
	Audio Output	1-ch MIC bidirectional talk audio output
	Audio Compression Standard	G.711a, G.711u, PCM, G726 (The bidirectional talk supports G.711a, G.711u, PCM only.)
Video Parameters	Video Input	8/16/32/64-ch network compression video input
	Video Output	1-channel VGA 2-channel HDMI.
	Video Compression Standard	H.264
	Window Split Mode	1/4/8/9/16/25/36/64-screen.
Alarm Parameters	Alarm Input	16-channel
	Alarm Output	6-channel relay output
Decode Parameters	Decode Type	MPEG4, MJPG, H.264, H.265
	Decode Capability	H.264/H.265: 64-channelxD1;32-channelx720P, 16-channel 1080P;4-channel 4K
Functions	Record Mode	Manual recording, motion detection recording, schedule recording and alarm recording. Priority: Manual recording>card number recording-> alarm recording>motion detection recording>schedule recording.
	Multi-Channel Playback	Max support 16-channel 1080P playback at the same time.
	Motion Detect	Each screen supports 396/330((PAL 22x18, NTSC 22x15) detection zones. Various sensitivity levels.
	Privacy Mask	Each channel supports 4 privacy mask zones.
	Record Mode	Overwrite
	Backup Mode	Flash disk, eSATA, DVD burner.
	Network Protocol	IPv4/IPv6/HTTP/UPnP/NTP/SADP/SNMP/PPPoE/DNS/FTP/ONVIF(Version 2.4)/PSIA
	SATA Port	8 SATA Ports

Network Function	eSATA Port	1 eSATA port
	RS232 Port	1 RS232 port. To debug and transmit COM data.
	RS485 Port	1 RS485 port. To control peripheral PTZ and etc. Support various protocols.
	USB Port	2 USB 2.0 ports at the front panel and 2 USB3.0 ports at the rear panel.
	HDMI Port	2 HDMI ports
	Network Port	2 RJ45 10/100/1000Mbps self-adaptive Ethernet ports
	Power Port	One power socket. Power adapter power supplying. Input AC 100V~240V, 50Hz~60Hz.
	Power On-off Button	One at the rear panel.
	Indicator Light	4 indicator lights. <ul style="list-style-type: none"> ● 1 system running status indicator light ● 1 HDD indicator light ● 1 network status indicator light ● 1 power status indicator light
General Parameters	Power	AC90~264V
	Power Consumption	General series: 16.7W (No HDD) 16 PoE series: 17.5W (No HDD)
	Working Temperature	-10℃~55℃
	Working Humidity	10%~90% (No condensation)
	Dimensions (W×H×D)	439.7×95×450.8mm
	Weight (No HDD)	General series:6.55Kg, PoE series: 7Kg.
	Installation Mode	Rack/desktop

1.3.21 NVR48/48-16P Series

Model		NVR48 Series	NVR48-16P Series
System	System Resources	8/16/32-channel series product support 8/16/32-channel HD connection respectively. The main stream bandwidth supports 200Mbps.	
	Operation System	Embedded Linux real-time operation system	
	Operation Interface	WEB/Local GUI	
Decode	Video Compression	H.264/MJPEG/MPEG4	

	Decode Capacity	Max supports 16-channel D1, or 8-channel 720P, or 4-channel 3M or 2*5M decode.	
Video	Video Input	8/16/32-ch network compression video input	
	Video Output	1-channel VGA analog video output.	
	HDMI	1-ch HDMI output. Version number is 1.4	
	Window Split	1/4/8/9/16-window	
Audio	Audio Input	1-ch bidirectional talk input	
	Audio Output	1-ch bidirectional talk output	
	Audio Compression	G.711a	
Alarm	Alarm Input	16-ch alarm input	
	Alarm Output	4-ch alarm output Relay output. Relay (DC 30V /1A, AC 125V/0.5A (Activation output)) Including one controllable DC +12V output.	
Function	Storage	4 built-in SATA ports. 1 external eSATA port.	
	Multiple-channel Playback	Max 8-channel 720P/4-channel 1080P playback at the same time.	
Port and Indicator	RS232 Port	One RS232 port to debug transparent COM data.	
	RS485 port	One RS485 port to control PTZ. Support various protocols.	
	USB2.0 Port	3 peripheral USB2.0 ports. Two at the front panel and one at the rear panel.	
	Network Connection	Two RJ45 10/100/1000Mbps self-adaptive Ethernet ports.	One RJ45 10/100/1000Mbps self-adaptive Ethernet port.
	Power Port	One power port. Input 100-240V, 50~60Hz.	
	Power Button	One button. At the rear panel.	
	Power On-off Button	One button. At the front-panel.	
	IR Receiver	Support IR remote control	

	Window	
	Clock	Built-in clock.
General	Indicator Light	One power status indicator light. One network status indicator light. One HDD status indicator light.
	Power Consumption	<30W(No HDD)
	Working Temperature	-10℃~+55℃
	Working Humidity	10%—90%
	Air pressure	86kpa—106kpa
	Dimension	440mm x 460mm x 89mm
	Weight	5.5kg~6.5kg (No HDD)
	Installation	Desk installation

1.3.22 NVR72/72-8P Series

Model		NVR72 Series	NVR72-8P Series
System	System Resources	8/16/32/64-channel series product support 8/16/32/64-channel HD connection respectively. The main stream bandwidth supports 48/96/192/192Mbps.	
	Operation System	Embedded Linux real-time operation system	
	Operation Interface	WEB/Local GUI	
Decode	Video Compression	H.264/MJPEG	
	Decode Capacity	Max supports 32-channel D1, or 16-channel 720P, or 8-channel 1080P decode.	
Video	Video Input	8/16/32/64-ch network compression video input	
	Video Output	1-channel VGA analog video output.	
	HDMI	1-ch HDMI output. Version number is 1.4	
	Window	1/4/8/9/16/25/36-window	

	Split		
Audio	Audio Input	1-ch bidirectional talk input	
	Audio Output	1-ch bidirectional talk output	
	Audio Compression	G.711a	
Alarm	Alarm Input	8-ch alarm output	
	Alarm Output	3-ch alarm output Relay output. Relay (DC 30V/1A, AC 125V/0.5A (Activation output)) Including one controllable DC +12V output.	
Function	Storage	2 built-in SATA ports.	
	Multiple-channel Playback	Max 16-channel 720P/8-channel 1080P playback at the same time.	
Port and Indicator	RS232 Port	One RS232 port to debug transparent COM data.	
	RS485 port	One RS485 port to control PTZ. Support various protocols.	
	USB2.0 Port	2 peripheral USB2.0 ports. One at the front panel and one at the rear panel.	
	Network Connection	1 RJ45 10/100Mbps self-adaptive Ethernet port.	
	Power Port	One power port, power adapter. Input DC 12V.	One power port. Input 100-240V, 47~63Hz.
	Power Button	One button. At the rear panel.	
	Power On-off Button	One button. At the front-panel.	
	IR Receiver Window	Support IR remote control	
	Clock	Built-in clock.	
General	Indicator Light	One power status indicator light. One network status indicator light. One HDD status indicator light.	
	Power Consumption	<30W(No HDD)	

	Working Temperature	-10℃~+55℃
	Working Humidity	10%—90%
	Air pressure	86kpa—106kpa
	Dimension	1U case. 295mm×275mm×47mm
	Weight	1.5kg~2.5kg (No HDD)
	Installation	Desk installation

1.3.23 NVR74/74-8P/74-16P Series

Model		NVR74 Series	NVR74-8P Series	NVR74-16P Series
System	System Resources	8/16/32/64-channel series product support 8/16/32/64-channel HD connection respectively. The main stream bandwidth supports 48/96/192/192Mbps.		
	Operation System	Embedded Linux real-time operation system		
	Operation Interface	WEB/Local GUI		
Decode	Video Compression	H.264/MJPEG		
	Decode Capacity	Max supports 32-channel D1, or 16-channel 720P, or 8-channel 1080P decode.		
Video	Video Input	8/16/32/64-ch network compression video input		
	Video Output	1-channel VGA analog video output.		
	HDMI	1-ch HDMI output. Version number is 1.4		
	Window Split	1/4/8/9/16/25/36-window		
Audio	Audio Input	1-ch bidirectional talk input		
	Audio Output	1-ch bidirectional talk output		
	Audio Compression	G.711a		
Alarm	Alarm Input	16-ch alarm input		

	Alarm Output	6-ch alarm output Relay output. Relay (DC 30V /1A, AC 125V/0.5A (Activation output)) Including one controllable DC +12V output.	
	Function	Storage	4 built-in SATA ports. 1 external eSATA port.
		Multiple-channel Playback	Max 16-channel 720P/8-channel 1080P playback at the same time.
Port and Indicator	RS232 Port	One RS232 port to debug transparent COM data.	
	RS485 port	One RS485 port to control PTZ. Support various protocols.	
	USB2.0 Port	3 peripheral USB2.0 ports. One at the front panel and two at the rear panel.	
	Network Connection	Two RJ45 10/100Mbps self-adaptive Ethernet ports.	One RJ45 10/100Mbps self-adaptive Ethernet port.
	Power Port	One power port. Input 100-240V, 50~60Hz.	
	Power Button	One button. At the rear panel.	
	Power On-off Button	One button. At the front-panel.	
	IR Receiver Window	Support IR remote control	
	Clock	Built-in clock.	
General	Indicator Light	One power status indicator light. One network status indicator light. One HDD status indicator light.	
	Power Consumption	<30W(No HDD)	
	Working Temperature	-10℃~+55℃	
	Working Humidity	10%—90%	
	Air pressure	86kpa—106kpa	
	Dimension	1.5U, 440mm × 460mm × 68mm	
	Weight	5kg~6kg (No HDD)	

	Installation	Desk installation
--	---------------------	-------------------

1.3.24 NVR78/78-16P/78-RH Series

Model		NVR78 Series	NVR78-16P Series	NVR78-RH Series
System	System Resources	8/16/32/64-channel series product support 8/16/32/64-channel HD connection respectively. The main stream bandwidth supports 48/96/192/192Mbps.		
	Operation System	Embedded Linux real-time operation system		
	Operation Interface	WEB/Local GUI		
Decode	Video Compression	H.264/MJPEG		
	Decode Capacity	Max supports 32-channel D1, or 16-channel 720P, or 8-channel 1080P decode.		
Video	Video Input	8/16/32/64-ch network compression video input		
	Video Output	1-channel VGA analog video output.		
	HDMI	1-ch HDMI output. Version number is 1.4	2-ch HDMI output (from different video sources)	
	Window Split	1/4/8/9/16/25/36-window		
Audio	Audio Input	1-ch bidirectional talk input		
	Audio Output	1-ch bidirectional talk output		
	Audio Compression	G.711a		
Alarm	Alarm Input	16-ch alarm input		
	Alarm Output	6-ch alarm output Relay output. Relay (DC 30V/1A, AC 125V/0.5A (Activation output)) Including one controllable DC +12V output.		
Function	Storage	8 built-in SATA ports. 1 external eSATA port.	8 built-in SATA ports at the front panel. Support hot swap, Raid0, Raid1, Raid5,	

			Raid6. 1 external eSATA port.	
	Multiple-channel Playback	Max 16-channel 720P/8-channel 1080P playback at the same time.		
Port and Indicator	RS232 Port	One RS232 port to debug transparent COM data.		
	RS485 port	One RS485 port to control PTZ. Support various protocols.		
	USB2.0 Port	4 peripheral USB2.0 ports. Two at the front panel and two at the rear panel.		
	Network Connection	Two RJ45 10/100/1000 Mbps self-adaptive Ethernet ports.	One RJ45 10/100/1000 Mbps self-adaptive Ethernet port.	Two RJ45 10/100/1000 Mbps self-adaptive Ethernet ports.
	Power Port	One power port. Input 100-240V, 50~60Hz.		
	Power Button	One button. At the rear panel.		
	Power On-off Button	One button. At the front-panel.		
	IR Receiver Window	Support IR remote control		
	Clock	Built-in clock.		
General	Indicator Light	One power status indicator light. One network status indicator light. One HDD status indicator light.		
	Power Consumption	<35W(No HDD)		
	Working Temperature	-10℃~+55℃		
	Working Humidity	10%—90%		
	Air pressure	86kpa—106kpa		
	Dimension	440mm×460mm×89mm	444mm×430mm×89mm	
	Weight	5.5kg~6.5kg (No HDD)	8.5kg ~ 9.5kg (No HDD)	
	Installation	Desk installation		

	n	
--	---	--

1.3.25 NVR70/70-R Series

Model		NVR70 Series	NVR70-R Series
System	System Resources	8/16/32/64-channel series product support 8/16/32/64-channel HD connection respectively. The main stream bandwidth supports 48/96/192/192Mbps.	
	Operation System	Embedded Linux real-time operation system	
	Operation Interface	WEB/Local GUI	
Decode	Video Compression	H.264/MJPEG	
	Decode Capacity	Max supports 32-channel D1, or 16-channel 720P, or 8-channel 1080P decode.	
Video	Video Input	8/16/32/64-ch network compression video input	
	Video Output	1-channel VGA analog video output.	
	HDMI	1-ch HDMI output.	2-ch HDMI output (from different video sources)
	Window Split	1/4/8/9/16/25/36-window	
Audio	Audio Input	1-ch bidirectional talk input	
	Audio Output	1-ch bidirectional talk output	
	Audio Compression	G.711a	
Alarm	Alarm Input	16-ch alarm input	
	Alarm Output	6-ch alarm output Relay output. Relay (DC 30V/1A, AC 125V/0.5A (Activation output)) Including one controllable DC +12V output.	
Function	Storage	16 built-in SATA ports at the front panel. Support removable HDD installation mode. 1 external eSATA port.	16 built-in SATA ports at the front panel. Support hot swap, Raid0, Raid1, Raid5, Raid6. 1 external eSATA port.
	Multiple-channel Playback	Max 16-channel 720P/8-channel 1080P playback at the same time.	

Port and Indicator	RS232 Port	One RS232 port to debug transparent COM data.
	RS485 port	One RS485 port to control PTZ. Support various protocols.
	USB2.0 Port	4 peripheral USB2.0 ports. Two at the front panel and two at the rear panel.
	Network Connection	Two RJ45 10/100Mbps self-adaptive Ethernet ports.
	Power Port	One power port. Input 100V~240V, 50~60Hz.
	Power Button	One button. At the rear panel.
	Power On-off Button	One button. At the front-panel.
	IR Receiver Window	Support IR remote control
	Clock	Built-in clock.
General	Indicator Light	One power status indicator light. One network status indicator light. One HDD status indicator light.
	Power Consumption	<35W(No HDD)
	Working Temperature	-10℃~+55℃
	Working Humidity	10%—90%
	Air pressure	86kpa—106kpa
	Dimension	3U case: 448mm×490mm×133.2mm
	Weight	10.5kg~11.5kg (No HDD)
	Installation	Desk installation

1.3.26 NVR42V-8P Series

Model	NVR42V-8P	
System	System Resources	8/16/32-channel series product support 8/16/32-channel HD connection respectively. Main stream bandwidth supports 80/160/160Mbps

		respectively.
	Operation System	Embedded Linux real-time operation system
	Operation Interface	WEB/Local GUI
Decode	Video Compression	H.264/MJPEG/MPEG4
	Decode Capacity	Max supports 16-channel D1, or 8-channel 720P, or 4-channel 1080P, or 4*3M or 2*5M decode.
Video	Video Input	8/16/32-ch network compression video input
	Video Output	1-channel VGA analog video output.
	HDMI	1-ch HDMI output. Version number is 1.4
	Window Split	1/4/8/9/16-window
Audio	Audio Input	1-ch bidirectional talk input
	Audio Output	1-ch bidirectional talk output
	Audio Compression	G.711a
Alarm	Alarm Input	2-ch alarm input
	Alarm Output	1-ch alarm output
Function	Storage	2 built-in SATA ports.
	Multiple-channel Playback	Max 8-channel 720P/4-channel 1080P playback at the same time.
Port and Indicator	RS232 Port	N/A
	RS485 port	N/A
	USB Port	Two USB2.0 ports at the front panel and one USB3.0 port at the rear panel. .
	Network Connection	1 RJ45 10/100/1000Mbps self-adaptive Ethernet port and 8 PoE ports.
	Power Port	One power port. Input DC 53V--2.3A
	Power Button	One button. At the rear panel.
	Power On-off Button	N/A
	IR Receiver Window	Support IR remote control
	Clock	Built-in clock.

	Indicator Light	One power status indicator light. One network status indicator light. One HDD status indicator light. One alarm status indicator light.
General	Power Consumption	<30W(No HDD)
	Working Temperature	-10℃~+55℃
	Working Humidity	10%—90%
	Air pressure	86kpa—106kpa
	Dimension	100mm×220mm×146mm
	Weight	1.5kg~2.5kg (No HDD)
	Installation	Desk installation

1.3.27 NVR41-4KS2/41-P-4KS2/41-8P-4KS2 Series

Model		41-4KS2 Series	41-P-4KS2 Series	41-8P-4KS2 Series
System	Main Processor	Industrial embedded micro processor		
	OS	Embedded Linux operation system		
	System Resources	4/8/16-channel series product main stream max support 80/80/80Mbps	4/8-channel series product main stream max support 80/80Mbps	8/16-channel series product main stream max support 80/80Mbps
	Operation Interface	WEB/Local GUI		
Audio	Audio Input	1-ch MIC bidirectional talk input		
	Audio Output	1-ch MIC bidirectional talk output		
	Audio Compression Standard	G.711a/G.711u/AAC/G.722.1/G726/G.729		
Video	Video Input	4/8/16-ch network compression video input	4/8-ch network compression video input	8/16-ch network compression video input
	Video Output	1-channel VGA video output, 1-channel HDMI output		
	Video Compression Standard	H.264		
	Window Split	1/4/8/9/16-window	1/4/8/9-window	1/4/8/9/16-window

Model		41-4KS2 Series	41-P-4KS2 Series	41-8P-4KS2 Series
Alarm	Alarm Input	N/A (Compatble with 2in/1out alarm panel)		N/A
	Alarm Output	N/A(Compatble with 2in/1out alarm panel)		N/A
Decode	Decode Type	MPEG4/MJPG/H.264/H.265		
	Decode Capability	H.264/H.265: 16-channel D1 or 16-channel 720P or 8-channel 1080P or 2-channel 4K		
Functon	Record Mode	Manual record, motion detect record, schedule record, alarm record. The record priority: Manual record>Alarm record>Motion detect record>Schedule record		
	Multiple-Chann el Playback	Max 8-channel 1080P playback		
	Motion Detect	Each video supports PAL 396(22*18)/ NTSC 330(22x15) detection zones, support multiple sensivityly levels.		
	Privacy Mask	Each channel supports 4 privacy mask zones		
	Record Storage	Overwrite		
	Backup Mode	USB device/DVD burner		
Port and Indicator	Network Protocol	IPv4/IPv6/HTTP/UPnP/NTP/SADP/SNMP/PPPoE/DNS/FTP/ONVI(V ersion2.4)/PSIA		
	SATA Port	One port		
	eSATA Port	N/A		
	RS232 Port	N/A		
	RS485 Port	N/A		
	USB Port	2 peripheral USB2.0 ports at the rear panel		
	Network Connection	1 RJ45 10/100Mbps self-adaptive Ethernet port.		
	PoE Port	N/A	4	8
	HDMI Port	One port		
	VGA Port	One port		
	Power Port	1 power socket. Power adapter power supplying mode. DC 12V/2A power.	1 power socket. Power adapter power supplying mode. DC 48V/72W power.	1 power socket. Power adapter power supplying mode. DC 48V/96W

Model		41-4KS2 Series	41-P-4KS2 Series	41-8P-4KS2 Series
				power.
	Power On-off Button	N/A		
	Indicator Light	Three indicator lights.		
General	Power Consumption	< 10W (No HDD)		
	Working Temperature	- 10°C ~ + 55°C		
	Working Humidity	10%~90%		
	Air pressure	86kPa~106kPa		
	Dimensions(m m)	205.3*45.6*204.2(D*H*W)		
	Weight	0.5kg~1kg (No HDD)		
	Installation Mode	Desk/rack installation		

1.3.28 NVR41HS-4KS2/ 41HS-P-4KS2/41HS-8P-4KS2 Series

Model		41HS-4KS2 Series	41HS-P-4KS2 Series	41HS-8P-4KS2 Series
System	Main Processor	Industrial embedded micro processor		
	OS	Embedded Linux operation system		
	System Resources	4/8/16-channel series product main stream max support 80/80/80Mbps	4/8-channel series product main stream max support 80/80Mbps	8/16-channel series product main stream max support 80/80Mbps
	Operation Interface	WEB/Local GUI		
Audio	Audio Input	1-ch MIC bidirectional talk input		
	Audio Output	1-ch MIC bidirectional talk output		
	Audio Compression Standard	G.711a/G.711u/AAC/G.722.1/G726/G.729		
Video	Video Input	4/8/16-ch network compression video input	4/8-ch network compression video input	8/16-ch network compression video input

Model		41HS-4KS2 Series	41HS-P-4KS2 Series	41HS-8P-4KS2 Series
	Video Output	1-channel VGA video output, 1-channel HDMI output		
	Video Compression Standard	H.264		
	Window Split	1/4/8/9/16-window	1/4/8/9-window	1/4/8/9/16-window
Alarm	Alarm Input	N/A (Compatble with 2in/1out alarm panel)		
	Alarm Output	N/A(Compatble with 2in/1out alarm panel)		
Decode	Decode Type	MPEG4/MJPEG/H.264/H.265		
	Decode Capability	H.264/H.265: 16-channel D1 or 16-channel 720P or 8-channel 1080P or 2-channel 4K		
Funciton	Record Mode	Manual record, motion detect record, schedule record, alarm record. The record priority: Manual record>Alarm record>Motion detect record>Schedule record		
	Multiple-Channel Playback	Max 8-channel 1080P playback		
	Motion Detect	Each video supports PAL 396(22*18)/ NTSC 330(22x15) detection zones, support multiple sensivityly levels.		
	Privacy Mask	Each channel supports 4 privacy mask zones		
	Record Storage	Overwrite		
	Backup Mode	USB device/DVD burner		
Port and Indicator	Network Protocol	IPv4/IPv6/HTTP/UPnP/NTP/SADP/SNMP/PPPoE/DNS/FTP/ONVI(V ersion2.4)/PSIA		
	SATA Port	One port		
	eSATA Port	N/A		
	RS232 Port	N/A		
	RS485 Port	N/A		
	USB Port	2 peripheral USB ports: one USB 2.0 port at the front panel and one USB3.0 port at the rear panel		
	Network Connection	1 RJ45 10/100Mbps self-adaptive Ethernet port.		

Model		41HS-4KS2 Series	41HS-P-4KS2 Series	41HS-8P-4KS2 Series
	PoE Port	N/A	4	8
	HDMI Port	One port		
	VGA Port	One port		
	Power Port	1 power socket. Power adapter power supplying mode. DC 12V/2A power.	1 power socket. Power adapter power supplying mode. DC 48V/72W power.	1 power socket. Power adapter power supplying mode. DC 48V/96W power.
	Power On-off Button	N/A		
	Indicator Light	Three indicator lights.		
	General	Power Consumption	6.3W (No HDD)	7.5W (No HDD)
Working Temperature		- 10°C ~ + 55°C		
Working Humidity		10%~90%		
Air pressure		86kPa~106kPa		
Dimensions(m m)		224.9*47.6*260(D*H*W)		
Weight		1.2Kg (No HDD)	1.6Kg (No HDD)	2.1Kg (No HDD)
Installation Mode		Desk/rack installation		

1.3.29 NVR42-4KS2/42-P-4KS2/42-8P-4KS2/42-16P-4KS2 Series

Model		42-4KS2 Series	42-P-4KS2 Series	42-8P-4KS2 Series	42-16P-4KS2 Series
System	Main Processor	Industrial embedded micro processor			
	OS	Embedded Linux operation system			
	System Resources	8/16/32-channel series product main stream max support 200/200/200Mbps	4-channel series product main stream max support 200Mbps	8-channel series product main stream max support 200Mbps	16/32-channel series product main stream max support 200/200Mbps
	Operation	WEB/Local GUI			

Model		42-4KS2 Series	42-P-4KS2 Series	42-8P-4KS2 Series	42-16P-4KS2 Series
	Interface				
Audio	Audio Input	1-ch MIC bidirectional talk input			
	Audio Output	1-ch MIC bidirectional talk output			
	Audio Compression Standard	G.711a/G.711u/AAC/G.722.1/G726/G.729			
Video	Video Input	8/16/32-ch network compression video input	4-ch network compression video input	8-ch network compression video input	16/32-ch network compression video input
	Video Output	1-channel VGA video output, 1-channel HDMI output			
	Video Compression Standard	H.264			
	Window Split	1/4/8/9/16/32-window	1/4-window	1/4/8/9-window	1/4/8/9/16/32-window
Alarm	Alarm Input	4-channel input			
	Alarm Output	2-channel output:1-channel relay output, 1-channel 12V control			
Decode	Decode Type	MPEG4/MJPEG/H.264/H.265			
	Decode Capability	H.264/H.265: 32-channel D1 or 16-channel 720P or 8-channel 1080P or 2-channel 4K			
Function	Record Mode	Manual record, motion detect record, schedule record, alarm record. The record priority: Manual record>Alarm record>Motion detect record>Schedule record			
	Multiple-Channel Playback	Max 8-channel 1080P playback			
	Motion Detect	Each video supports PAL 396(22*18)/ NTSC 330(22*15) detection zones, support multiple sensitivity levels.			
	Privacy Mask	Each channel supports 4 privacy mask zones			
	Record Storage	Overwrite			
	Backup Mode	USB device/DVD burner			

Model		42-4KS2 Series	42-P-4KS2 Series	42-8P-4KS2 Series	42-16P-4KS2 Series
Port and Indicator	Network Protocol	IPv4/IPv6/HTTP/UPnP/NTP/SADP/SNMP/PPPoE/DNS/FTP/ONV1(Version2.4)/PSIA			
	SATA Port	Two ports			
	eSATA Port	N/A			
	RS232 Port	N/A			
	RS485 Port	N/A			
	USB Port	2 peripheral USB ports: one USB 2.0 port at the front panel and one USB3.0 port at the rear panel			
	Network Connection	1 RJ45 10/100/1000Mbps self-adaptive Ethernet port.			
	PoE Port	N/A	4	8	16
	HDMI Port	One port			
	VGA Port	One port			
	Power Port	1 power socket. Power adapter power supplying mode. DC 12V/4A power.	1 power socket. Power adapter power supplying mode. DC 48V/96W power.	1 power socket. Power adapter power supplying mode. AC90V~264V-12V5A/52V2.5 A-190W power.	1 power socket. Power adapter power supplying mode. AC90V~264V-12V5A/52V2.5 A-190W power.
	Power On-off Button	One at the rear panel			
	Indicator Light	Four indicator lights.			
General	Power Consumption	4.2W (No HDD) 21.72W (With HDD)			
	Working Temperature	- 10°C ~ + 55°C			
	Working Humidity	10%~90%			
	Air pressure	86kPa~106kPa			
	Dimensions(m m)	320mm x 48.2mm x 375mm(D*H*W)			
	Weight	3.2Kg (No HDD)		4.1Kg (No HDD)	
	Installation Mode	Desk/rack installation			

1.3.30 NVR44-4KS2/44-16P-4KS2 Series

Model		44-4KS2 Series	44-16P-4KS2 Series
System	Main Processor	Industrial embedded micro processor	
	OS	Embedded Linux operation system	
	System Resources	16/32-channel series product main stream max support 200/200Mbps	16/32-channel series product main stream max support 200/200Mbps
	Operation Interface	WEB/Local GUI	
Audio	Audio Input	1-ch MIC bidirectional talk input	
	Audio Output	1-ch MIC bidirectional talk output	
	Audio Compression Standard	G.711a/G.711u/AAC/G.722.1/G726/G.729	
Video	Video Input	16/32-ch network compression video input	
	Video Output	1-channel VGA video output, 1-channel HDMI output	
	Video Compression Standard	H.264	
	Window Split	1/4/8/9/16/32-window	
Alarm	Alarm Input	16-channel input	
	Alarm Output	4-channel output:3-channel relay output, 1-channel 12V control	
Decode	Decode Type	MPEG4/MJPEG/H.264/H.265	
	Decode Capability	H.264/H.265: 32-channel D1 or 16-channel 720P or 8-channel 1080P or 2-channel 4K	
Function	Record Mode	Manual record, motion detect record, schedule record, alarm record. The record priority: Manual record>Alarm record>Motion detect record>Schedule record	
	Multiple-Channel Playback	Max 8-channel 1080P playback	
	Motion Detect	Each video supports PAL 396(22*18)/ NTSC 330(22*15) detection zones, support multiple sensitivity levels.	
	Privacy Mask	Each channel supports 4 privacy mask zones	

Model		44-4KS2 Series	44-16P-4KS2 Series
	Record Storage	Overwrite	
	Backup Mode	USB device/DVD burner	
Port and Indicator	Network Protocol	IPv4/IPv6/HTTP/UPnP/NTP/SADP/SNMP/PPPoE/DNS/FTP/ONVI(Version2.4)/PSIA	
	SATA Port	Four ports	
	eSATA Port	N/A	
	RS232 Port	N/A	
	RS485 Port	N/A	
	USB Port	2 peripheral USB ports: one USB 2.0 port at the front panel and one USB3.0 port at the rear panel	
	Network Connection	Two RJ45 10/100/1000Mbps self-adaptive Ethernet ports. One Ethernet card	One RJ45 10/100/1000Mbps self-adaptive Ethernet port
	PoE Port	N/A	16
	HDMI Port	One port	
	VGA Port	One port	
	Power Port	1 power socket. Power adapter power supplying mode. AC90V~264V-12V5.7A/-12V0.5A-75W	1 power socket. Power adapter power supplying mode. AC90V~264V-12V12.5A/-53V2.83A
	Power On-off Button	One at the rear panel	
	Indicator Light	Four indicator lights.	
General	Power Consumption	4.2W (No HDD) 21.72W (With HDD)	
	Working Temperature	- 10°C ~ + 55°C	
	Working Humidity	10%~90%	
	Air pressure	86kPa~106kPa	
	Dimensions(m m)	405*72*440(D*H*W)	
	Weight	7.00Kg (No HDD)	
	Installation Mode	Desk/rack installation	

1.3.31 NVR48-4KS2/48-16P-4KS2

Model		48-4KS2 Series	48-16P-4KS2 Series
System	Main Processor	Industrial embedded micro processor	
	OS	Embedded Linux operation system	
	System Resources	16/32-channel series product main stream max support 200/200Mbps	16/32-channel series product main stream max support 200/200Mbps
	Operation Interface	WEB/Local GUI	
Audio	Audio Input	1-ch MIC bidirectional talk input	
	Audio Output	1-ch MIC bidirectional talk output	
	Audio Compression Standard	G.711a/G.711u/AAC/G.722.1/G726/G.729	
Video	Video Input	16/32-ch network compression video input	
	Video Output	1-channel VGA video output, 1-channel HDMI output	
	Video Compression Standard	H.264	
	Window Split	1/4/8/9/16/32-window	
Alarm	Alarm Input	16-channel input	
	Alarm Output	4-channel output:3-channel relay output, 1-channel 12V control	
Decode	Decode Type	MPEG4/MJPEG/H.264/H.265	
	Decode Capability	H.264/H.265: 32-channel D1 or 16-channel 720P or 8-channel 1080P or 2-channel 4K	
Funciton	Record Mode	Manual record, motion detect record, schedule record, alarm record. The record priority: Manual record>Alarm record>Motion detect record>Schedule record	
	Multiple-Channel Playback	Max 8-channel 1080P playback	
	Motion Detect	Each video supports PAL 396(22*18)/ NTSC 330(22*15) detection zones, support multiple sensivityly levels.	
	Privacy Mask	Each channel supports 4 privacy mask zones	

Model		48-4KS2 Series	48-16P-4KS2 Series
	Record Storage	Overwrite	
	Backup Mode	USB device/DVD burner	
Port and Indicator	Network Protocol	IPv4/IPv6/HTTP/UPnP/NTP/SADP/SNMP/PPPoE/DNS/FTP/ONVI(Version2.4)/PSIA	
	SATA Port	Eight ports	
	eSATA Port	N/A	
	RS232 Port	N/A	
	RS485 Port	One A/B port	
	USB Port	Three peripheral USB ports: Two USB 2.0 ports at the front panel and one USB3.0 port at the rear panel	
	Network Connection	Two RJ45 10/100/1000Mbps self-adaptive Ethernet ports. One Ethernet card	One RJ45 10/100/1000Mbps self-adaptive Ethernet port.
	PoE Port	N/A	16
	HDMI Port	One port	
	VGA Port	One port	
	Power Port	1 power socket. Power adapter power supplying mode. AC90V~264V-12V12.5A	1 power socket. Power adapter power supplying mode. AC90V~264V-12V12.5A/-53V2.83A
	Power On-off Button	One at the rear panel	
	Indicator Light	Four indicator lights.	
General	Power Consumption	4.2W (No HDD) 21.72W (With HDD)	
	Working Temperature	- 10°C ~ + 55°C	
	Working Humidity	10%~90%	
	Air pressure	86kPa~106kPa	
	Dimensions(mm)	445.5mm×90.65mm×439.7mm(D*H*W)	
	Weight	9.80Kg (No HDD)	
	Installation Mode	Desk/rack installation	

2 Front Panel and Rear Panel

2.1 Front Panel

2.1.1 NVR11/11-P/41/41-P/41-W/21-S2/21-P-S2/21-8P-S2/41-4KS2/41-P-4KS2/41-8P-4K S2 Series

The front panel is shown as in Figure 2-1.

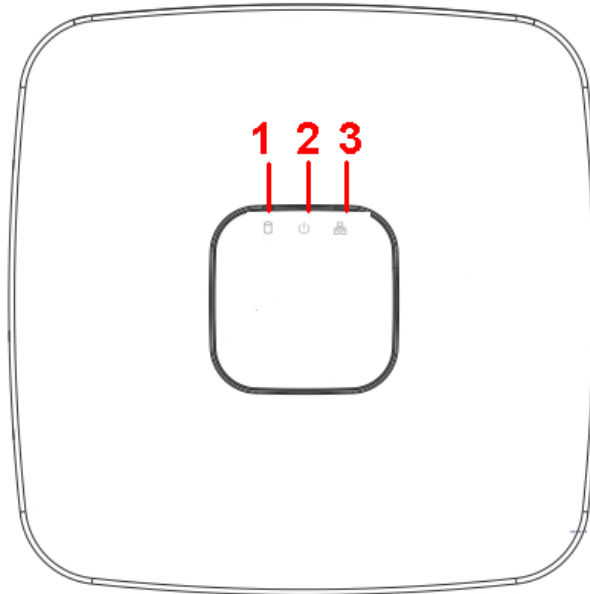

Figure 2-1

Please refer to the following sheet for detailed information.

SN	Name	Function
1	HDD status indicator light	The red light becomes on when HDD is abnormal.
2	Power indicator light	The red light becomes on when the power connection is OK.
3	Network status indicator light	The red light becomes on when the network connection is abnormal.

2.1.2 NVR11H/11H-P/41H/41H-P/41H-8P Series

The front panel is shown as in Figure 2-2.

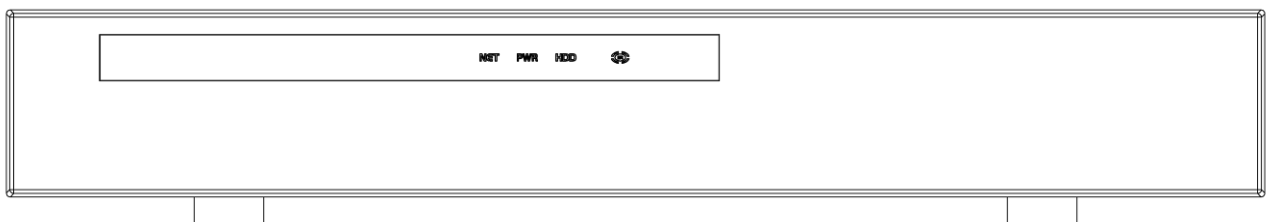

Figure 2-2

Please refer to the following sheet for detailed information.

Icon	Name	Function
NET	Network status indicator light	The red light becomes on when the network connection is abnormal.
PWR	Power indicator light	The red light becomes on when the power connection is OK.
HDD	HDD status indicator light	The red light becomes on when HDD is abnormal.
IR	Remote control receiver	It is to receive signal from the remote control.

2.1.3 NVR11HS Series

The front panel is shown as below. See Figure 2-3.

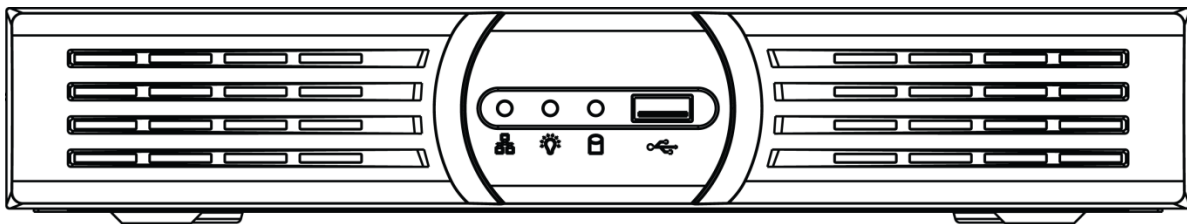





Figure 2-3

Please refer to the following sheet for detailed information.

Icon	Name	Function
	Network status indicator light	The red light becomes on when the network connection is abnormal.
	Power status indicator light	The red light becomes on when the power connection is OK.
	HDD status indicator light	The red light becomes on when the HDD is abnormal.
	USB port	Connect to USB mouse, USB devices and etc.

2.1.4 NVR41HS-W-S2 Series

The front panel is shown as below. See Figure 2-4.

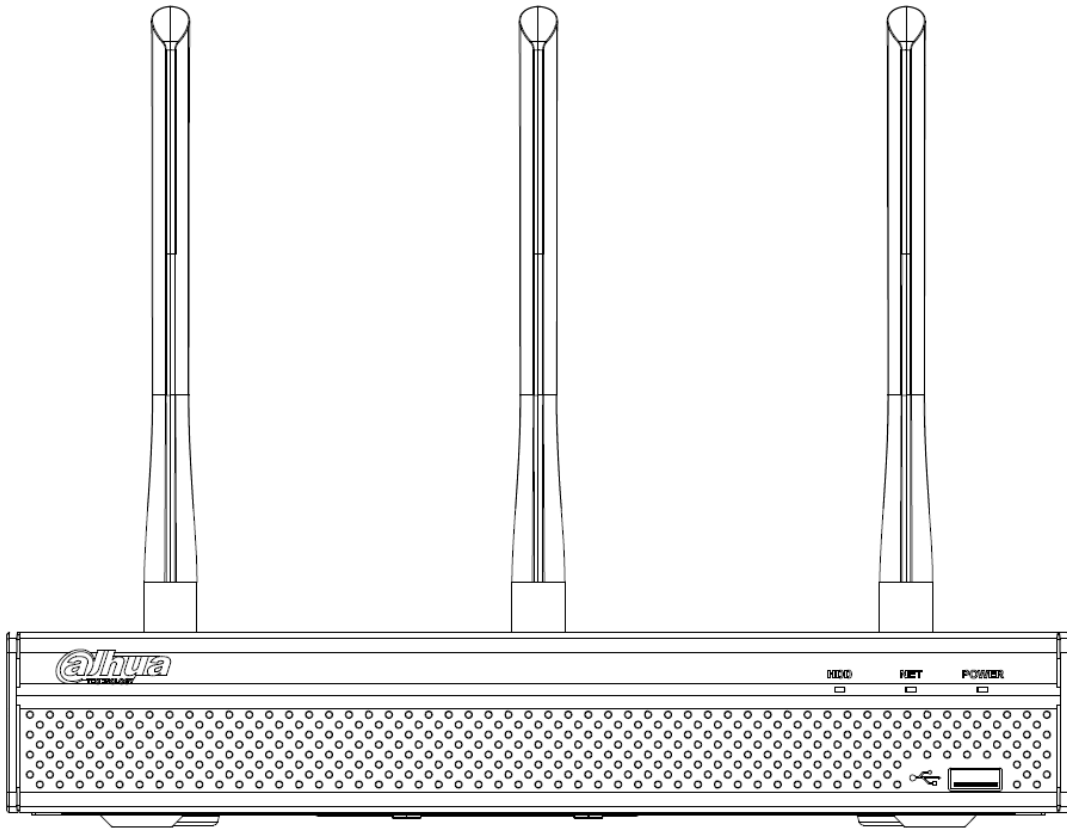

Figure 2-4

Please refer to the following sheet for front panel button information.

Icon	Name	Function
HDD	HDD status indicator light	The blue light is on when the HDD is malfunction.
NET	Network status indicator light	The blue light is on when the network connection is abnormal.
POWER	Power status indicator light	The blue light is on when the power connection is OK.
	USB2.0 port	Connect to peripheral USB 2.0 storage device, mouse, burner and etc.

2.1.5 NVR41-8P Series

The front panel is shown as below. See Figure 2-5.

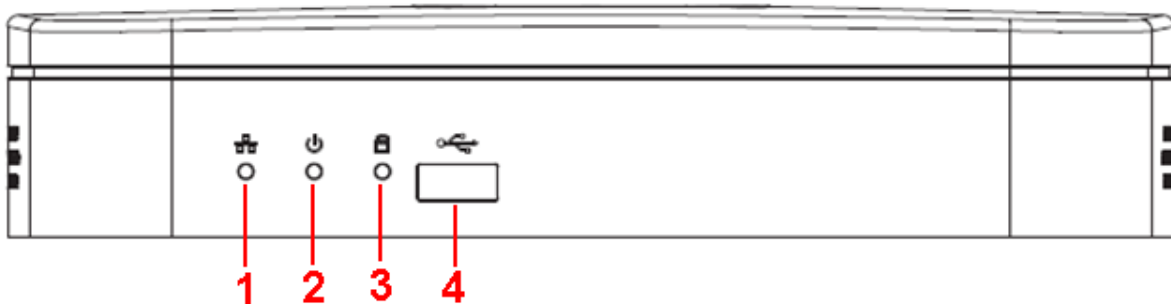

Figure 2-5

Please refer to the following sheet for detailed information.

SN	Name	Function
1	Network status indicator light	The red light becomes on when the network connection is abnormal.
2	Power indicator light	The red light becomes on when the power connection is OK.
3	HDD status indicator light	The red light becomes on when HDD is abnormal.
4	USB	USB port

2.1.6 NVR42/42-P/42-8P/72/72-8P Series

The front panel is shown as below. See Figure 2-6.

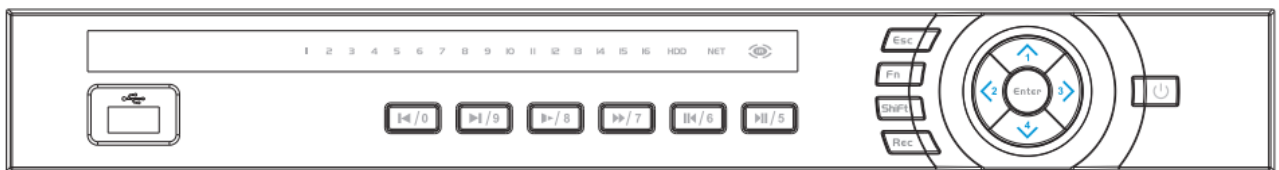











Figure 2-6

Please refer to the following sheet for front panel button information.

Name	Icon	Function
Power button		Power button, press this button for three seconds to boot up or shut down NVR.
Shift	Shift	In textbox, click this button to switch between numeral, English(Small/Capitalized),donation and etc.
Up/1 Down/4		Activate current control, modify setup, and then move up and down.
		Increase/decrease numeral.
		Assistant function such as PTZ menu.
		In text mode, input number 1/4 (English character G/H/I)
Left/2 Right/3		Shift current activated control,
		When playback, click these buttons to control playback bar. In text mode, input number 2(English character A/B/C) /3(English character D/E/F)
ESC	ESC	Go to previous menu, or cancel current operation.
		When playback, click it to restore real-time monitor mode.
Enter	ENTER	Confirm current operation
		Go to default button

		Go to menu
Record	REC	Manually stop/start recording, working with direction keys or numeral keys to select the recording channel.
Slow play/8		Multiple slow play speeds or normal playback. In text mode, input number 8 (English character T/U/V).
Assistant	Fn	One-window monitor mode, click this button to display assistant function: PTZ control and image color.
		Backspace function: in numeral control or text control, press it for 1.5seconds to delete the previous character before the cursor.
		In motion detection setup, working with Fn and direction keys to realize setup.
		In text mode, click it to switch between numeral, English character(small/capitalized) and etc.
		Realize other special functions.
Fast play/7		Various fast speeds and normal playback. In text mode, input number 7 (English character P/Q/R/S).
Play previous/0		In playback mode, playback the previous video In text mode, input number 0.
Reverse/Pause/6		In normal playback or pause mode, click this button to reverse playback In reverse playback, click this button to pause playback.
Play Next/9		In playback mode, playback the next video In menu setup, go to down ward of the dropdown list. In text mode, input number 9 (English character W/X/Y/Z)
Play/Pause /5		In normal playback click this button to pause playback In pause mode, click this button to resume playback. In text mode, input number 5(English character J/K/L).
USB port		To connect USB storage device, USB mouse.
Network abnormal indicator light	Net	Network error occurs or there is no network connection, the light becomes red to alert you.
HDD abnormal indicator light	HDD	HDD error occurs or HDD capacity is below specified threshold value, the light becomes red to alert you.
Record light	1-16	System is recording or not. It becomes on when system is recording.

IR Receiver	IR	It is to receive the signal from the remote control.
-------------	----	--

2.1.7 NVR21HS-S2/21HS-P-S2/21HS-8P-S2 /41HS-4KS2/ 41HS-P-4KS2/41HS-8P-4KS2 Series

The NVR21HS-S2/21HS-P-S2/21HS-8P-S2/41HS-4KS2/41HS-P-4KS2/41HS-8P-4KS2 series front panel is shown as below. See Figure 2-7.

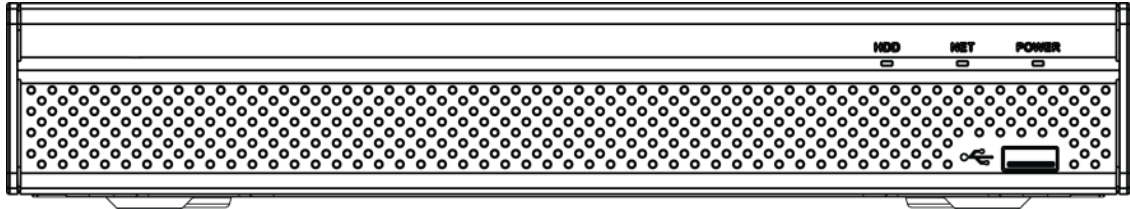

Figure 2-7

Please refer to the following sheet for front panel button information.

Icon	Name	Function
HDD	HDD status indicator light	The blue light is on when the HDD is malfunction.
NET	Network status indicator light	The blue light is on when the network connection is abnormal.
POWER	Power status indicator light	The blue light is on when the power connection is OK.
	USB port	Connect to peripheral USB storage device, mouse and etc.

2.1.8 NVR/22-S2/22-P-S2/22-8P-S2/42-16P/42N/42-4K/42-8P-4K/44-4K/48-4K/52-4KS2/ 52-8P-4KS2/52-16P-4KS2/54-4KS2/58-4KS2/42-4KS2/42-P-4KS2/42-8P-4KS2/42-16P-4KS2/ 44-4KS2/44-16P-4KS2/48-4KS2/48-16P-4KS2 Series

The

NVR22-S2/22-P-S2/22-8P-S2/42-16P/42N/42-4K/42-8P-4K/52-4KS2/52-8P-4KS2/52-16P-4KS2//42-4K S2/42-P-4KS2/42-8P-4KS2/42-16P-4KS2 series front panel is shown as in Figure 2-8.

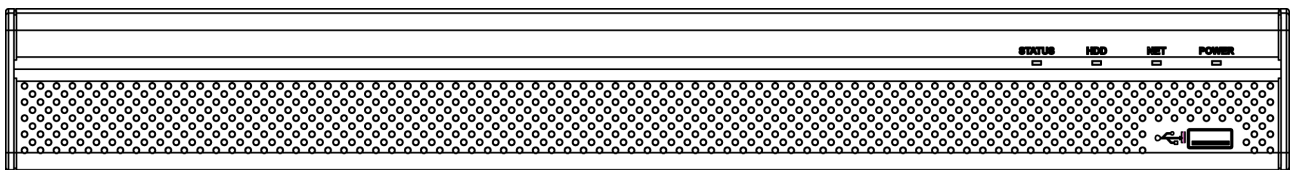

Figure 2-8

The NVR44-4K/54-4KS2/54-16P-4KS2/44-4KS2/44-16P-4KS2 series front panel is shown as in Figure 2-9.

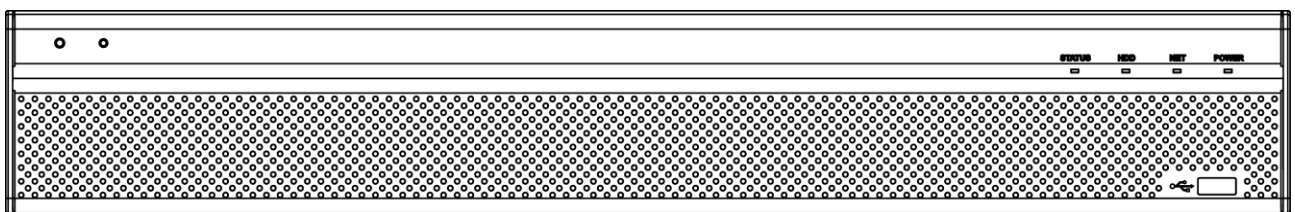

Figure 2-9

The NVR48-4K/58-4K/58-16P-4KS2/48-4KS2/48-16P-4KS2 series front panel is shown as in Figure 2-10.

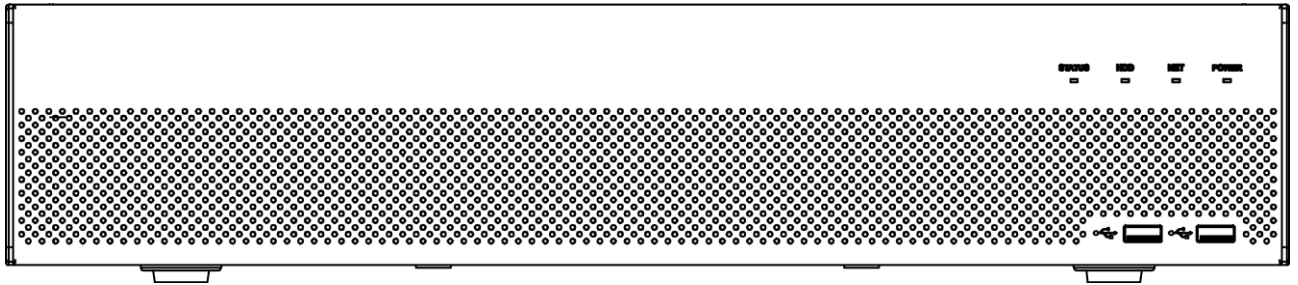

Figure 2-10

Please refer to the following sheet for front panel button information.

Icon	Name	Function
STATUS	Status indicator light	The blue light is on when the device is malfunction.
HDD	HDD status indicator light	The blue light is on when the HDD is malfunction.
NET	Network status indicator light	The blue light is on when the network connection is abnormal.
POWER	Power status indicator light	The blue light is on when the power connection is OK.
	USB2.0 port	Connect to peripheral USB 2.0 storage device, mouse, burner and etc.

2.1.9 NVR44/44-8P/44-16P/74/74-8P/74-16P Series

The front panel is shown as in Figure 2-11.

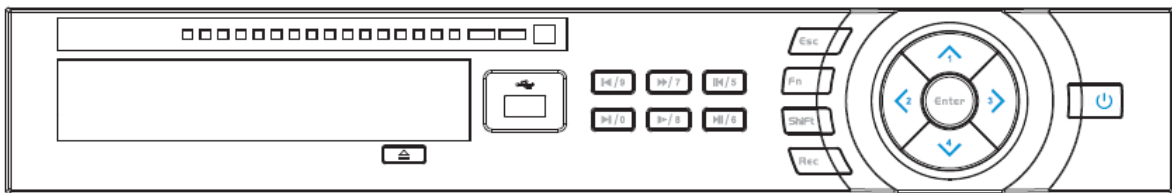



Figure 2-11

Please refer to the following sheet for front panel button information.

Name	Icon	Function
Power button		Power button, press this button for three seconds to boot up or shut down NVR.
Shift	Shift	In textbox, click this button to switch between numeral, English(Small/Capitalized),donation and etc.
Up/1 Down/4		Activate current control, modify setup, and then move up and down.

		Increase/decrease numeral.
		Assistant function such as PTZ menu.
		In text mode, input number 1/4 (English character G/H/I)
Left/2 Right/3	◀ ▶	Shift current activated control, When playback, click these buttons to control playback bar. In text mode, input number 2(English character A/B/C) /3(English character D/E/F)
ESC	ESC	Go to previous menu, or cancel current operation. When playback, click it to restore real-time monitor mode.
Enter	ENTER	Confirm current operation Go to default button Go to menu
Record	REC	Manually stop/start recording, working with direction keys or numeral keys to select the recording channel.
Slow play/8	▶	Multiple slow play speeds or normal playback. In text mode, input number 8 (English character T/U/V).
Assistant	Fn	One-window monitor mode, click this button to display assistant function: PTZ control and image color. Backspace function: in numeral control or text control, press it for 1.5seconds to delete the previous character before the cursor. In motion detection setup, working with Fn and direction keys to realize setup. In text mode, click it to switch between numeral, English character(small/capitalized) and etc. Realize other special functions.
Fast play/7	▶▶	Various fast speeds and normal playback. In text mode, input number 7 (English character P/Q/R/S).
Play previous/0	◀	In playback mode, playback the previous video In text mode, input number 0.
Reverse/Pause/6	◀	In normal playback or pause mode, click this button to reverse playback In reverse playback, click this button to pause playback.
Play Next/9	▶	In playback mode, playback the next video In menu setup, go to down ward of the dropdown list. In text mode, input number 9 (English character W/X/Y/Z)

Play/Pause /5	▶	In normal playback click this button to pause playback In pause mode, click this button to resume playback. In text mode, input number 5(English character J/K/L).
USB port		To connect USB storage device, USB mouse.
Network abnormal indicator light	Net	Network error occurs or there is no network connection, the light becomes red to alert you.
HDD abnormal indicator light	HDD	HDD error occurs or HDD capacity is below specified threshold value, the light becomes red to alert you.
Record light	1-16	System is recording or not. It becomes on when system is recording.

2.1.10 NVR48/48-16P/78/78-16P Series

The Front panel is shown as follows. See Figure 2-12.

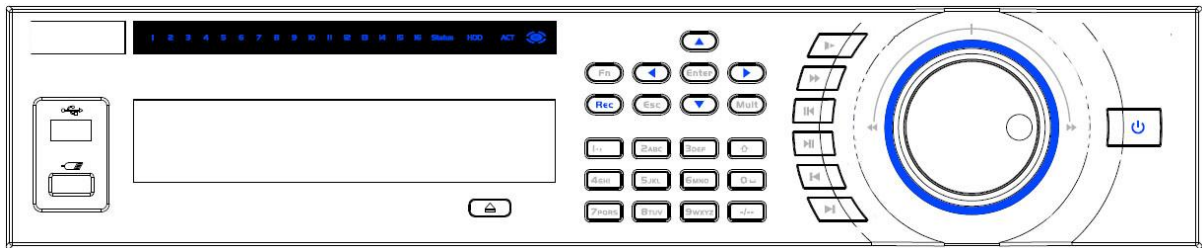



Figure 2-12

Please refer to the following sheet for front panel button information.

Name	Icon	Function
Power button		Power button, press this button for three seconds to boot up or shut down NVR.
Number button	0-9	Input Arabic number Switch channel
Input number more than 10	-/--	If you want to input a number more than 10, please click this button and then input.
Shift	↑	In textbox, click this button to switch between numeral, English(Small/Capitalized),donation and etc. Enable or disable tour.
Up/ Down	▲、▼	Activate current control, modify setup, and then move up and down.
		Increase/decrease numeral.
		Assistant function such as PTZ menu.

Left/ Right	◀ ▶	Shift current activated control, and then move left and right.
		When playback, click these buttons to control playback bar.
ESC	ESC	Go to previous menu, or cancel current operation.
		When playback, click it to restore real-time monitor mode.
Enter	ENTER	Confirm current operation
		Go to default button
		Go to menu
Record	REC	Manually stop/start recording, working with direction keys or numeral keys to select the recording channel.
Slow play	▶	Multiple slow play speeds or normal playback.
Assistant	Fn	One-window monitor mode, click this button to display assistant function: PTZ control and image color.
		Backspace function: in numeral control or text control, press it for 1.5seconds to delete the previous character before the cursor.
		In motion detection setup, working with Fn and direction keys to realize setup.
		In text mode, click it to switch between numeral, English character(small/capitalized) and etc.
		In HDD management interface, you can click it to switch HDD record information and other information (Menu prompt)
		Realize other special functions.
Fast play	▶▶	Various fast speeds and normal playback.
Play previous	◀	In playback mode, playback the previous video
Reverse/Pause	◀	In normal playback or pause mode, click this button to reverse playback In reverse playback, click this button to pause playback.
Play Next	▶	In playback mode, playback the next video In menu setup, go to down ward of the dropdown list.
Play/Pause	▶	In normal playback click this button to pause playback In pause mode, click this button to resume playback.
Window switch	Mult	Click it to switch one-window/multiple-window.

Shuttle(outer ring)		In real-time monitor mode it works as left/right direction key. Playback mode, counter clockwise to forward and clock wise to backward.
Jog(inner dial)		Up/down direction key. Playback mode, turn the inner dial to realized frame by frame playback. (Only applies to some special versions.)
USB port		To connect USB storage device, USB mouse.
Remote control indicator light	ACT	Remote control indicator light
Status indicator light	Status	If there is Fn indicator light, current status indicator light is null.
Power indicator light	PWR	Power indicator light
Channel indicator light	1-32	For 4/8/16-channel series product. The corresponding channel light becomes on when system is recording. For 32/64-channel series product: When the light flashes slowly, it means the corresponding channel of 1-16 channel is recording now (Such as channel 1). When the light flashes fast, it means the corresponding channel of 17-32 channel is recording now (Such as channel 17) When the light becomes on, It means the corresponding 2 channels are recording now (Such as channel 1 and channel 17.).
IR Receiver	IR	It is to receive the signal from the remote control.

2.1.11 NVR78-RH Series

The front panel is shown as below. See Figure 2-13.

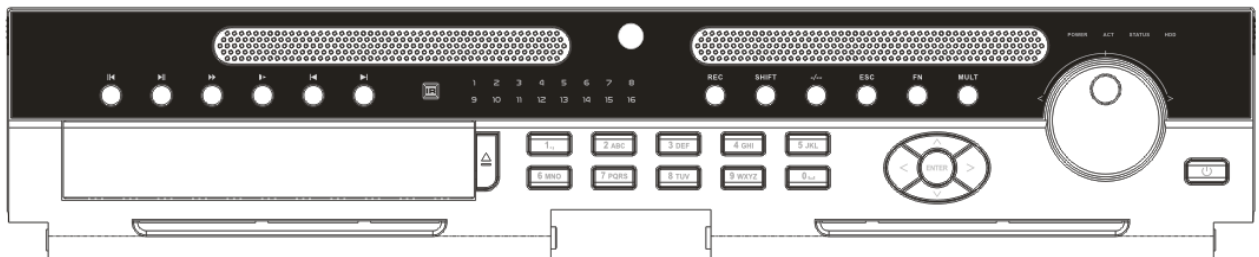









Figure 2-13

Please refer to the following sheet for front panel button information.

Name	Icon	Function
------	------	----------

Power button		Power button, press this button for three seconds to boot up or shut down NVR.
Number button	0-9	Input Arabic number Switch channel
Input number more than 10	-/--	If you want to input a number more than 10, please click this button and then input.
Shift		In textbox, click this button to switch between numeral, English(Small/Capitalized),donation and etc.
		Enable or disable tour.
Up/ Down		Activate current control, modify setup, and then move up and down.
		Increase/decrease numeral.
		Assistant function such as PTZ menu.
Left/ Right		Shift current activated control, and then move left and right.
		When playback, click these buttons to control playback bar.
ESC	ESC	Go to previous menu, or cancel current operation.
		When playback, click it to restore real-time monitor mode.
Enter	ENTER	Confirm current operation
		Go to default button
		Go to menu
Record	REC	Manually stop/start recording, working with direction keys or numeral keys to select the recording channel.
Slow play		Multiple slow play speeds or normal playback.
Assistant	Fn	One-window monitor mode, click this button to display assistant function: PTZ control and image color.
		Backspace function: in numeral control or text control, press it for 1.5 seconds to delete the previous character before the cursor.
		In motion detection setup, working with Fn and direction keys to realize setup.
		In text mode, click it to switch between numeral, English character(small/capitalized) and etc.
		In HDD management interface, you can click it to switch HDD record information and other information (Menu prompt)
		Realize other special functions.
Fast play		Various fast speeds and normal playback.

Play previous	◀	In playback mode, playback the previous video
Reverse/Pause	◀	In normal playback or pause mode, click this button to reverse playback In reverse playback, click this button to pause playback.
Play Next	▶	In playback mode, playback the next video In menu setup, go to down ward of the dropdown list.
Play/Pause	▶	In normal playback click this button to pause playback In pause mode, click this button to resume playback.
Window switch	Mult	Click it to switch one-window/multiple-window.
Shuttle(outer ring)		In real-time monitor mode it works as left/right direction key. Playback mode, counter clockwise to forward and clock wise to backward.
Jog(inner dial)		Up/down direction key. Playback mode, turn the inner dial to realized frame by frame playback. (Only applies to some special versions.)
USB port		To connect USB storage device, USB mouse.
Remote control receiver	IR	It is to receive signal from the remote control.
Remote control indicator light	ACT	Remote control indicator light
Status indicator light	Status	The light is on if device operates properly.
Power indicator light	POWER	Power indicator light
Record light	1-16	It becomes on when system is recording.
HDD abnormal status indicator light	HDD	It becomes on when there is no HDD, HDD error occurs, or HDD is full.

2.1.12 NVR70/70-R Series

The front panel is shown as in Figure 2-14.

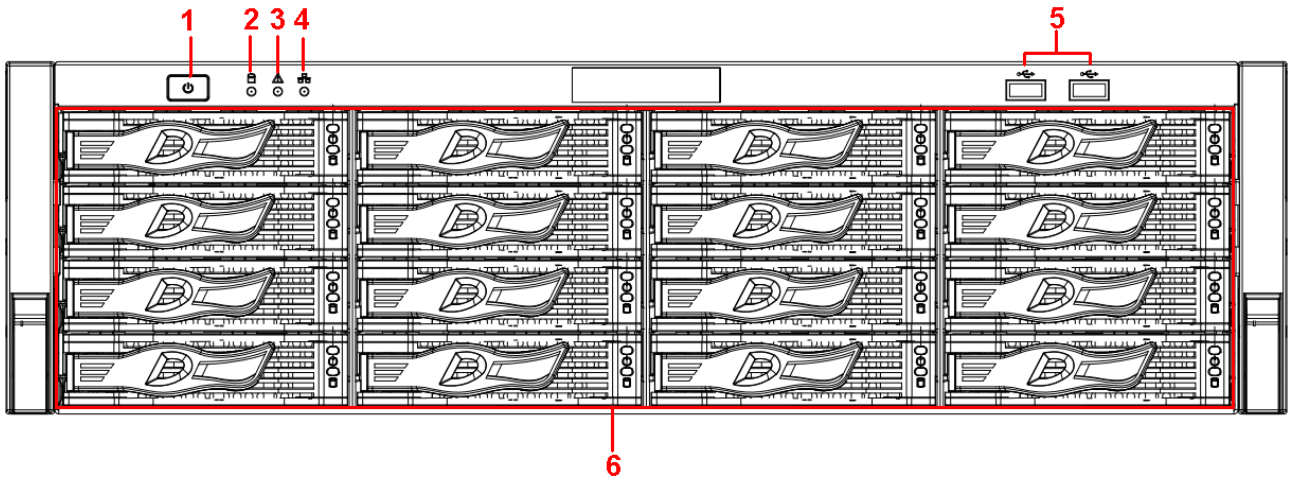

Figure 2-14

Please refer to the following sheet for front panel button information.

SN	Name	Icon	Function
1	Power button		Press it once to turn on the device. Press it for a long time to turn off the device (Usually we do not recommend). Press power button for a long time or pull out the power cable may result in device auto restart.
2	System HDD Indicator light		The blue light flashes when system is reading or writing the system HDD. In the system HDD, there are device important configuration file, factory default configuration file, device initial boot up data.
3	Alarm indicator light		The alarm indicator light becomes on once an alarm occurred. It becomes on via the software detection. The alarm includes local alarm, no disk and etc.
4	Network indicator light		The network indicator light is blue and it flashes when you connect the device to the network.
5	USB2.0 port		Connect to USB2.0 storage device, mouse, USB burner and etc.
6	16 HDD slot	-	/

After you remove the front panel, you can see there are 16 HDDs. From the left to the right and from the top to the bottom, it ranges from 1~4, 5~8, 6~12, 13~16. See Figure 2-15.

You can see there are two indicator lights on the HDD bracket.

- The power indicator light is at the top. The light is yellow after you connected the device to the power.
- The read-write indicator light is at the bottom. The blue light flashes when system is reading or writing the data.

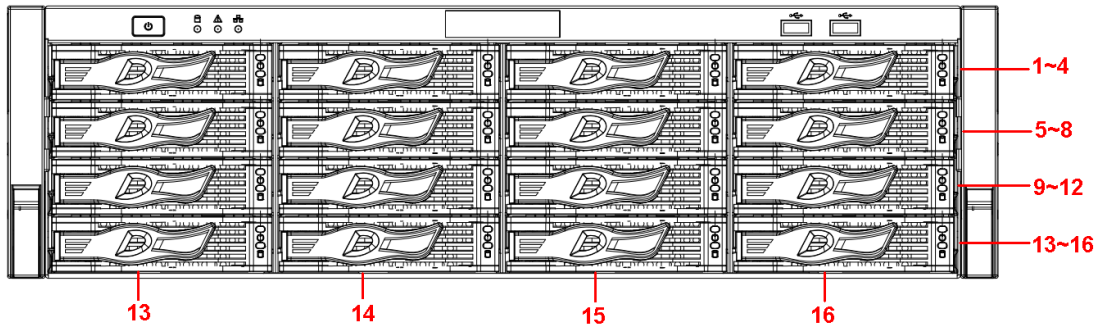

Figure 2-15

2.1.13 NVR42V-8P Series

The front panel is shown as below. See Figure 2-16

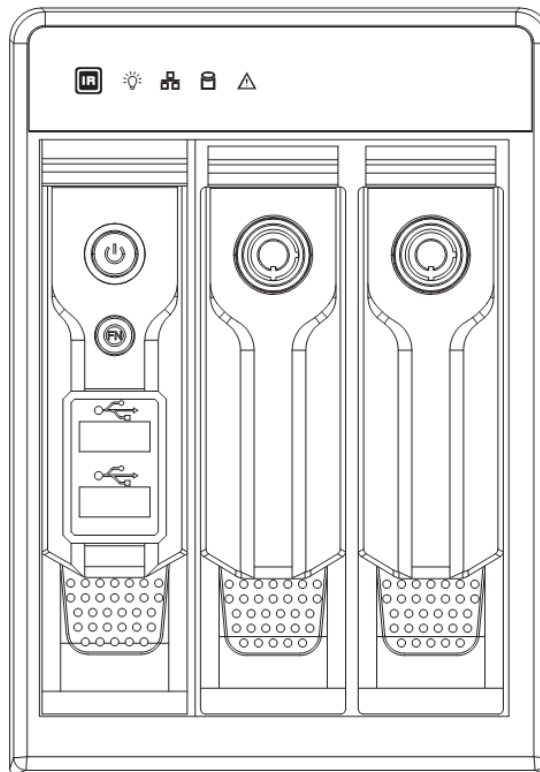

Figure 2-16

Please refer to the following sheet for front panel button information.

Name	Icon	Function
Power button		Power button, press this button for three seconds to boot up or shut down NVR.
Assistant	Fn	<ul style="list-style-type: none"> One-window monitor mode, click this button to display assistant function: PTZ control and image color. Backspace function: in numeral control or text control, press it for 1.5 seconds to delete the previous character before the cursor. In motion detection setup, working with Fn and direction keys to realize setup. In text mode, click it to switch between numeral, English

		<p>character (small/capitalized) and etc.</p> <ul style="list-style-type: none"> ● In HDD management interface, you can click it to switch HDD record information and other information (Menu prompt) ● Realize other special functions.
USB2.0 port		To connect USB2.0 storage device, USB2.0 mouse, burner and etc.
IR receive window		It is to receive the IR signal from the remote control.
Power indicator light		Power indicator light.
HDD abnormal indicator light		HDD error occurs or HDD capacity is below specified threshold value, the light becomes red to alert you.
Network abnormal indicator light		Network error occurs or there is no network connection, the light becomes red to alert you.
Alarm indicator light		The light becomes on when an alarm occurred.

2.2 Rear Panel

2.2.1 NVR100/100-P Series

The NVR100 rear panel is shown as below. See Figure 2-17.

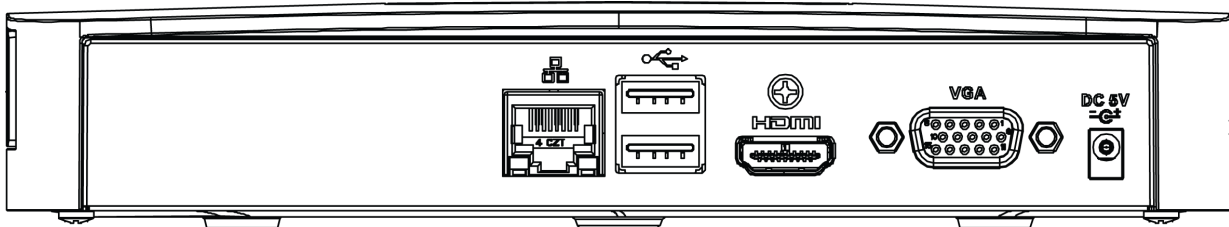

Figure 2-17

The NVR100-P rear panel is shown as below. See Figure 2-18.

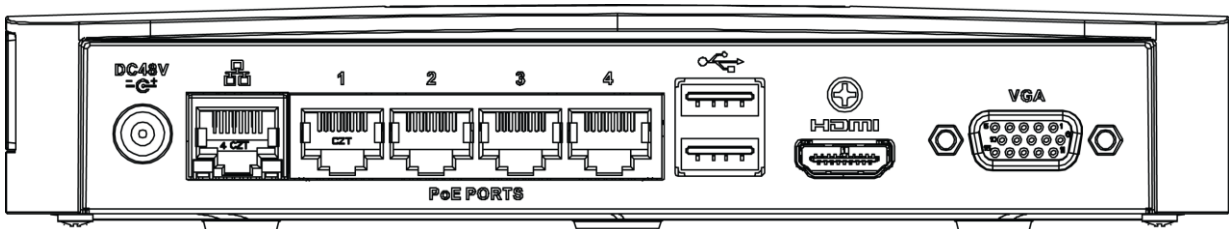



Figure 2-18

Please refer to the following sheet for detailed information.

Port Name	Connection	Function
	USB2.0 port	USB2.0 port. Connect to mouse, USB storage device, USB burner and etc.

Port Name	Connection	Function
	Network port	10M/100Mbps self-adaptive Ethernet port. Connect to the network cable.
HDMI	High Definition Media Interface	High definition audio and video signal output port. It transmits uncompressed high definition video and multiple-channel data to the HDMI port of the display device. HDMI version is 1.4.
VGA	VGA video output port	VGA video output port. Output analog video signal. It can connect to the monitor to view analog video.
	Power input port	Power socket. <ul style="list-style-type: none"> ● For NVR100 series, input DC 5V/2A. ● For NVR100-P series, input DC 48V/1.25A.
PoE PORT	PoE port	Built-in switch. Support PoE function. For PoE series product, you can use this port to provide power to the network camera.

2.2.2 NVR11/11-P Series

The NVR11 rear panel is shown as below. See Figure 2-19.

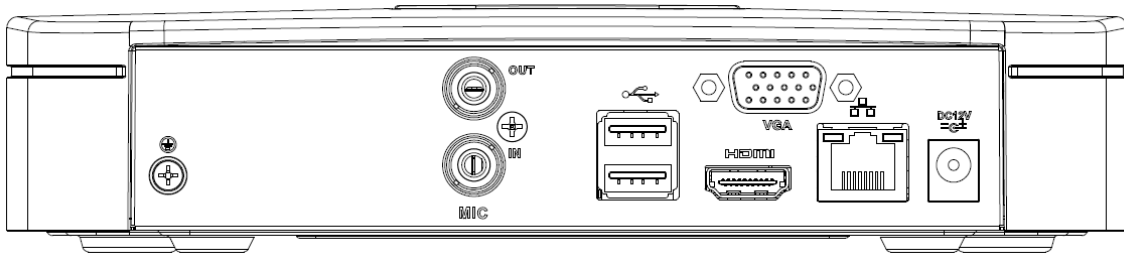

Figure 2-19

The NVR11-P rear panel is shown as below. See Figure 2-20.

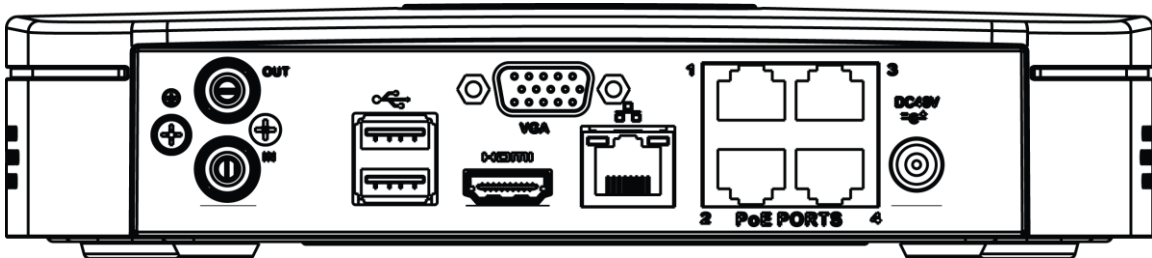





Figure 2-20

Please refer to the following sheet for detailed information.

Port Name	Connection	Function
	USB2.0 port	USB2.0 port. Connect to mouse, USB storage device, USB burner and etc.
	Network port	10M/100Mbps self-adaptive Ethernet port. Connect to the network cable.
HDMI	High Definition Media Interface	High definition audio and video signal output port. It transmits uncompressed high definition video and multiple-channel data to the HDMI port of the display device. HDMI version is 1.4.
VGA	VGA video output port	VGA video output port. Output analog video signal. It can connect to the monitor to view analog video.
	GND	Ground end
	Power input port	Power socket. <ul style="list-style-type: none"> ● For NVR11 series, input DC 12V/2A. ● For NVR11-P series, input DC 48V/1.25A.
MIC IN	Audio input port	Bidirectional talk input port. It is to receive the analog audio signal output from the devices such as microphone, pickup.
MIC OUT	Audio output port	Audio output port. It is to output the analog audio signal to the devices such as the sound box. <ul style="list-style-type: none"> ● Bidirectional talk output. ● Audio output on 1-window video monitor. ● Audio output on 1-window video playback.
PoE PORT	PoE port	Built-in switch. Support PoE function. For PoE series product, you can use this port to provide power to the network camera.

2.2.3 NVR41/41-P/41-8P/41-W Series

The NVR41 rear panel is shown as below. See Figure 2-21.

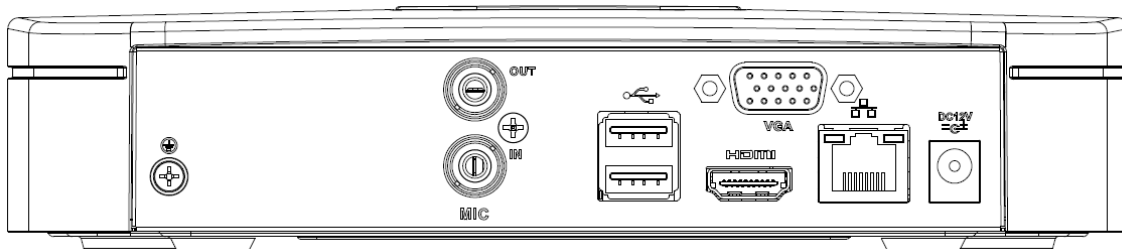

Figure 2-21

The NVR41-P rear panel is shown as below. See Figure 2-22.

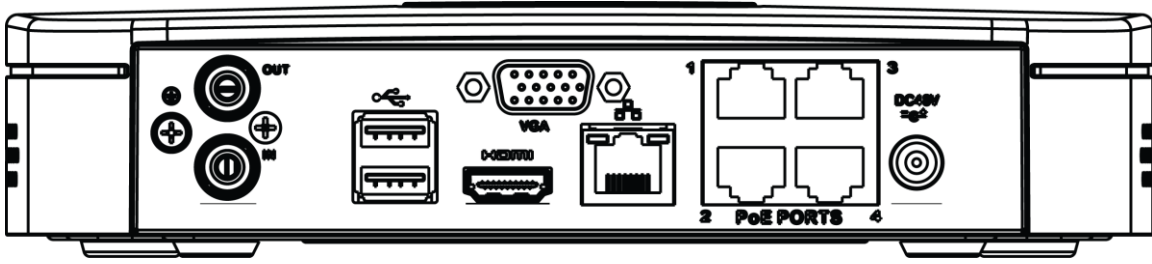

Figure 2-22

The NVR41-8P rear panel is shown as below. See Figure 2-23.

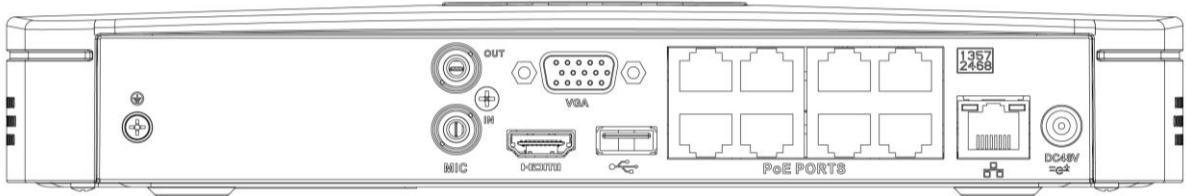

Figure 2-23

The NVR41-W rear panel is shown as below. See Figure 2-24.

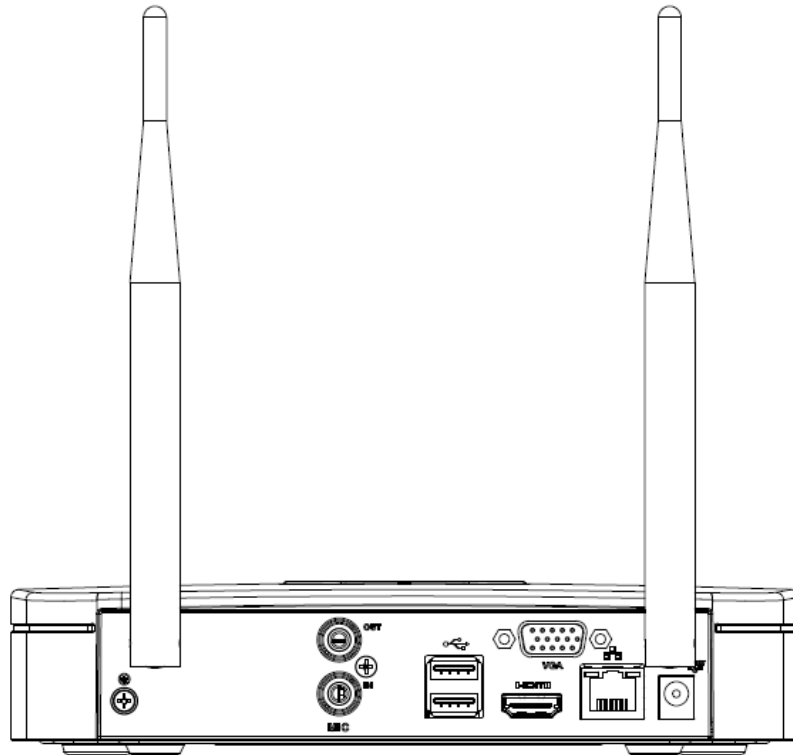

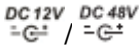

Figure 2-24

Please refer to the following sheet for detailed information.

Port Name	Connection	Function
	USB2.0 port	USB2.0 port. Connect to mouse, USB storage device, USB burner and etc.

Port Name	Connection	Function
	Network port	10M/100Mbps self-adaptive Ethernet port. Connect to the network cable.
HDMI	High Definition Media Interface	High definition audio and video signal output port. It transmits uncompressed high definition video and multiple-channel data to the HDMI port of the display device. HDMI version is 1.4.
VGA	VGA video output port	VGA video output port. Output analog video signal. It can connect to the monitor to view analog video.
	GND	Ground end
	Power input port	Power socket. <ul style="list-style-type: none"> ● For NVR41 series, input DC 12V/2A. ● For NVR41-P series, input DC 48V/1.5A. ● For NVR41-8P series, input DC 48V/2A.
MIC IN	Audio input port	Bidirectional talk input port. It is to receive the analog audio signal output from the devices such as microphone, pickup.
MIC OUT	Audio output port	Audio output port. It is to output the analog audio signal to the devices such as the sound box. <ul style="list-style-type: none"> ● Bidirectional talk output. ● Audio output on 1-window video monitor. ● Audio output on 1-window video playback.
PoE PORT	PoE port	Built-in switch. Support PoE function. For PoE series product, you can use this port to provide power to the network camera.
Wireless AP		Support wireless hotspot function. Use WIFI to connect to the network camera when there is a hotspot. For 41-W series only.

2.2.4 NVR21-S2/21-P-S2/21-8P-S2 Series

The NVR21-S2 is shown as in Figure 2-25.

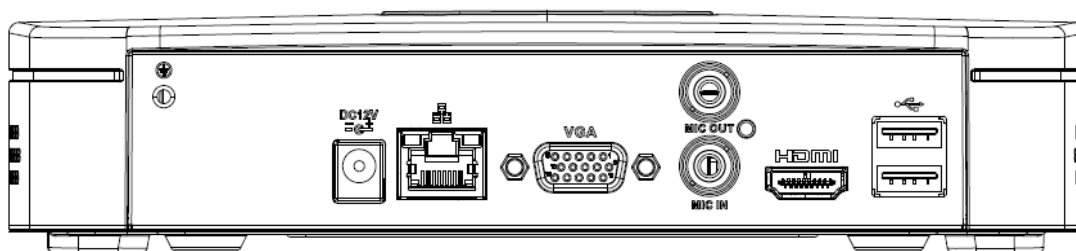

Figure 2-25

The NVR21-P-S2 is shown as in Figure 2-26.

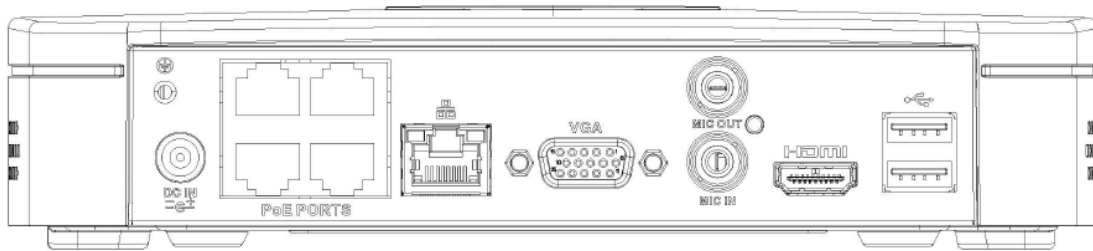

Figure 2-26

The NVR21-8P-S2 is shown as in Figure 2-27.

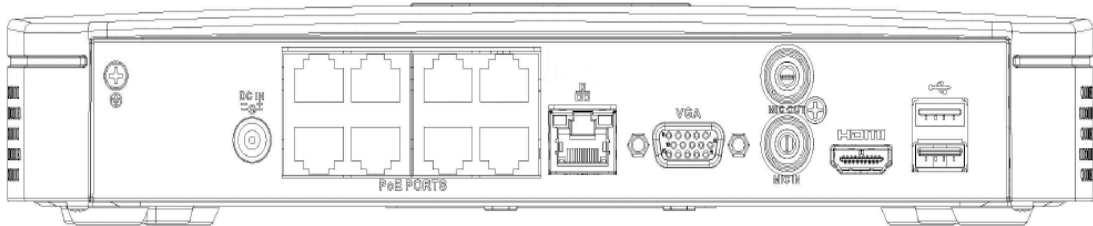





Figure 2-27

Please refer to the following sheet for detailed information.

Port Name	Connection	Function
	Power input port	Power socket <ul style="list-style-type: none"> For NVR21-S2, input DC 12V/2A. For NVR21-P-S2, input DC 48V/1.25A. For NVR21-8P-S2, input DC 48V/2A.
	Network port	10M/100Mbps self-adaptive Ethernet port. Connect to the network cable.
	USB port	USB port. Connect to mouse, USB storage device and etc.
HDMI	High Definition Media Interface	High definition audio and video signal output port. It transmits uncompressed high definition video and multiple-channel data to the HDMI port of the display device. HDMI version is 1.4.
VGA	VGA video output port	VGA video output port. Output analog video signal. It can connect to the monitor to view analog video.
MIC IN	Audio input port	Bidirectional talk input port. It is to receive the analog audio signal output from the devices such as microphone, pickup.
MIC OUT	Audio output port	Audio output port. It is to output the analog audio signal to the devices such as the sound box. <ul style="list-style-type: none"> Bidirectional talk output. Audio output on 1-window video monitor. Audio output on 1-window video playback.
	GND	Ground end

Port Name	Connection	Function
PoE PORTS	PoE port	Built-in switch. Support PoE function. For PoE series product, you can use this port to provide power to the network camera.

2.2.5 NVR11H/11H-P/41H/41H-P/41H-8P Series

The NVR11H/41H rear panel is shown as in Figure 2-28.

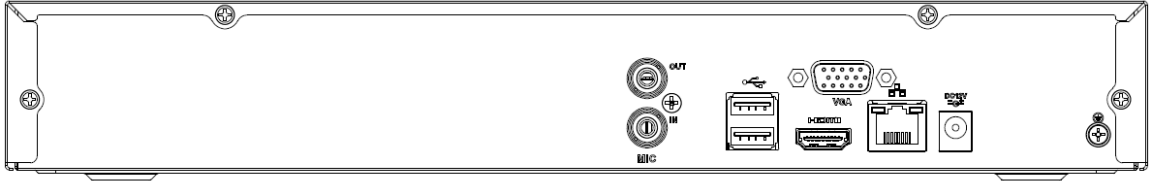

Figure 2-28

The NVR11H-P/41H-P rear panel is shown as in Figure 2-29.

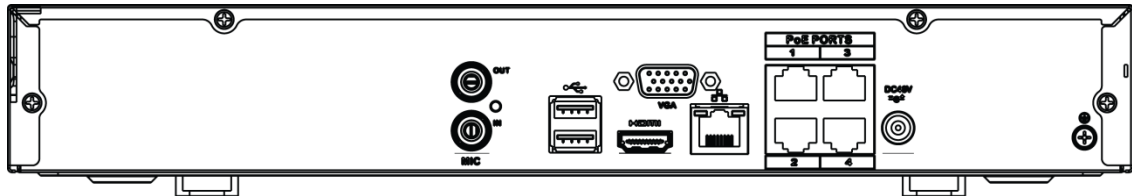

Figure 2-29

The NVR41H-8P rear panel is shown as in Figure 2-30.

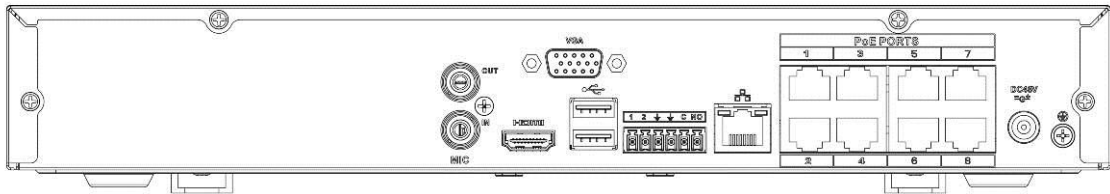

Figure 2-30

Please refer to the following sheet for detailed information.

Port Name	Connection	Function
	USB2.0 port	USB2.0 port. Connect to mouse, USB storage device, USB burner and etc.
	Network port	10M/100Mbps self-adaptive Ethernet port. Connect to the network cable.
HDMI	High Definition Media Interface	High definition audio and video signal output port. It transmits uncompressed high definition video and multiple-channel data to the HDMI port of the display device. HDMI version is 1.4.
VGA	VGA video output port	VGA video output port. Output analog video signal. It can connect to the monitor to view analog video.

Port Name	Connection	Function
	GND	Ground end
	Power input port	Power socket. <ul style="list-style-type: none"> ● For NVR41 series, input DC 12V/2A. ● For NVR41H-P series, input DC 48V/1.5A. ● For NVR11H-P series, input DC 48V/1.25A. ● For NVR41H-8P series, input DC 48V/2A.
MIC IN	Audio input port	Bidirectional talk input port. It is to receive the analog audio signal output from the devices such as microphone, pickup.
MIC OUT	Audio output port	Audio output port. It is to output the analog audio signal to the devices such as the sound box. <ul style="list-style-type: none"> ● Bidirectional talk output. ● Audio output on 1-window video monitor. ● Audio output on 1-window video playback.
PoE PORT	PoE port	Built-in switch. Support PoE function. For PoE series product, you can use this port to provide power to the network camera.

2.2.6 NVR11HS Series

The series rear panel is shown as below. See Figure 2-31.

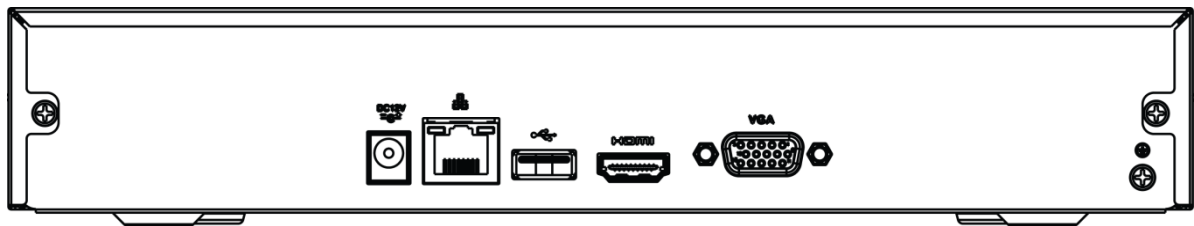

Figure 2-31

Please refer to the following sheet for detailed information.

Icon	Name	Function
	Power input socket.	Power socket. Input DC12V/1.5A.
	Network port	10M/100Mbps self-adaptive Ethernet port. Connect to the network cable.
	USB2.0 port	USB2.0 port. Connect to mouse, USB storage device, and etc.
HDMI	High Definition Media Interface	High definition audio and video signal output port. It transmits uncompressed high definition video and multiple-channel data to the HDMI port of the display device. HDMI version is 1.4.
VGA	VGA video output port	VGA video output port. Output analog video signal. It can connect to the monitor to view analog video.

Icon	Name	Function
	GND	Ground end

2.2.7 NVR21HS-S2/21HS-P-S2/21HS-8P-S2 Series

The NVR21HS-S2 series rear panel is shown as below. See Figure 2-32.

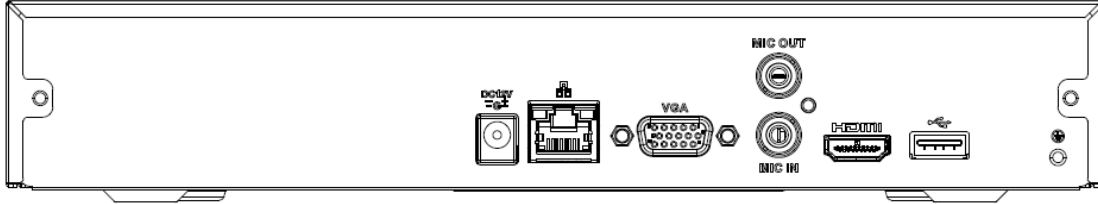

Figure 2-32

The NVR21HS-P-S2 series rear panel is shown as below. See Figure 2-33.

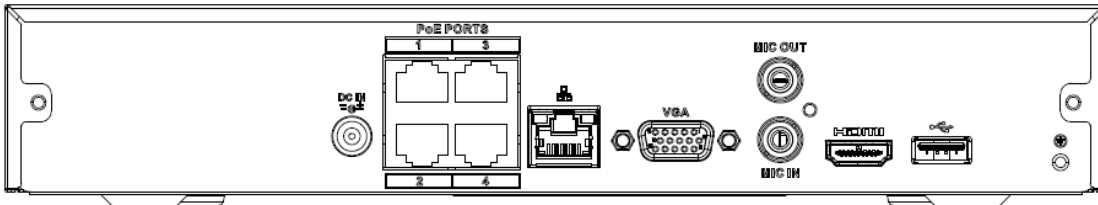

Figure 2-33

The NVR21HS-8P-S2 series rear panel is shown as below. See Figure 2-34.

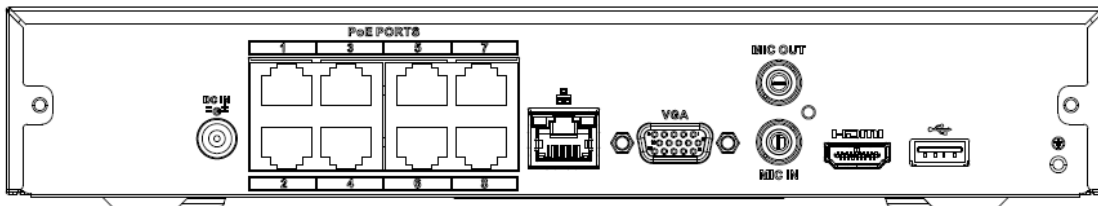

Figure 2-34

Please refer to the following sheet for detailed information.

Port Name	Connection	Function
	Power input port	Power socket. <ul style="list-style-type: none"> For NVR21HS-S2, input DC 12V/2A. For NVR21HS-P-S2, input DC 48V/1.25A. For NVR21HS-8P-S2, input DC 48V/2A.
	Network port	10M/100Mbps self-adaptive Ethernet port. Connect to the network cable.
	USB port	USB port. Connect to mouse, USB storage device and etc.
HDMI	High Definition Media Interface	High definition audio and video signal output port. It transmits uncompressed high definition video and multiple-channel data to the HDMI port of the display device. HDMI version is 1.4.

Port Name	Connection	Function
VGA	VGA video output port	VGA video output port. Output analog video signal. It can connect to the monitor to view analog video.
MIC IN	Audio input port	Bidirectional talk input port. It is to receive the analog audio signal output from the devices such as microphone, pickup.
MIC OUT	Audio output port	Audio output port. It is to output the analog audio signal to the devices such as the sound box. <ul style="list-style-type: none"> ● Bidirectional talk output. ● Audio output on 1-window video monitor. ● Audio output on 1-window video playback.
	GND	Ground end
PoE PORTS	PoE port	Built-in switch. Support PoE function. For PoE series product, you can use this port to provide power to the network camera.

2.2.8 NVR41HS-W-S2 Series

The NVR41HS-W-S2 rear panel is shown as below. See Figure 2-35.

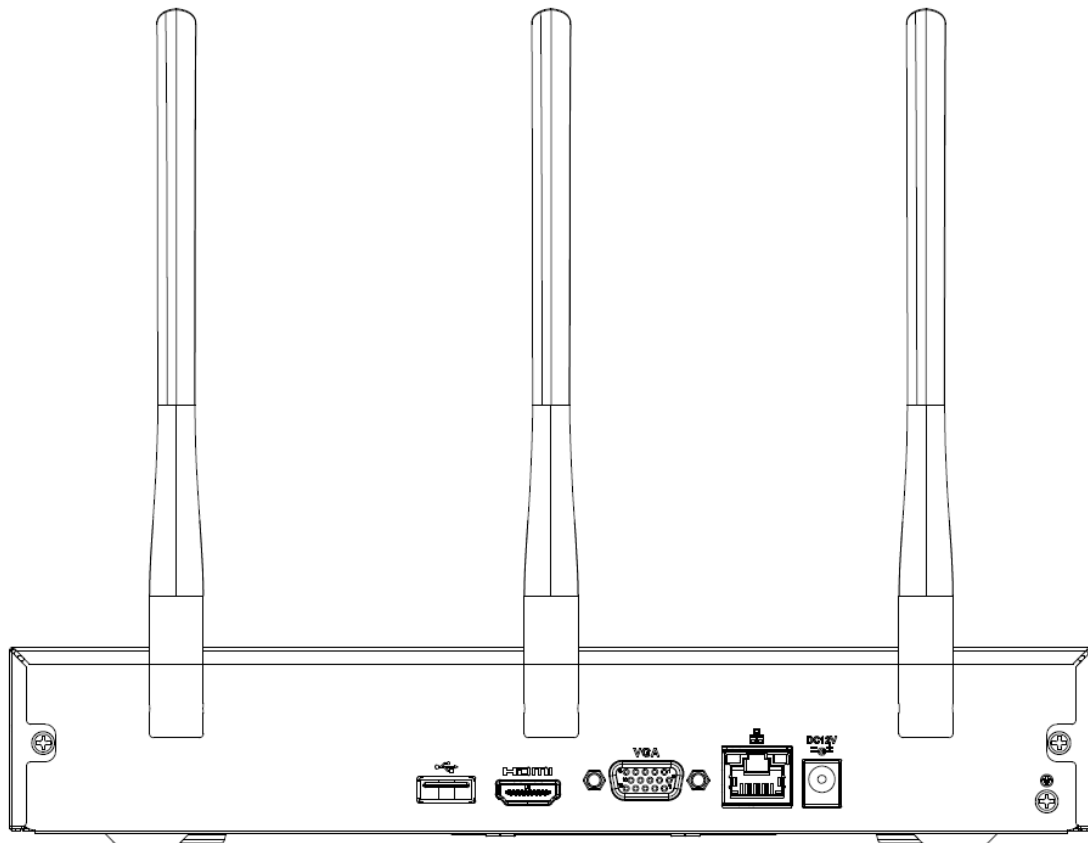

Figure 2-35

Please refer to the following sheet for detailed information.

Icon	Name	Function
------	------	----------

Icon	Name	Function
	Power input socket.	Power socket. Input DC12V/2A.
	Network port	10M/100Mbps self-adaptive Ethernet port. Connect to the network cable.
	USB2.0 port	USB2.0 port. Connect to mouse, USB storage device, and etc.
HDMI	High Definition Media Interface	High definition audio and video signal output port. It transmits uncompressed high definition video and multiple-channel data to the HDMI port of the display device. HDMI version is 1.4.
VGA	VGA video output port	VGA video output port. Output analog video signal. It can connect to the monitor to view analog video.
	GND	Ground end
Wireless AP		Support wireless hotspot function. Use WIFI to connect to the network camera when there is a hotspot.

2.2.9 NVR22-S2/22-P-S2/22-8P-S2 Series

The NVR22-S2 series rear panel is shown as below. See Figure 2-36.

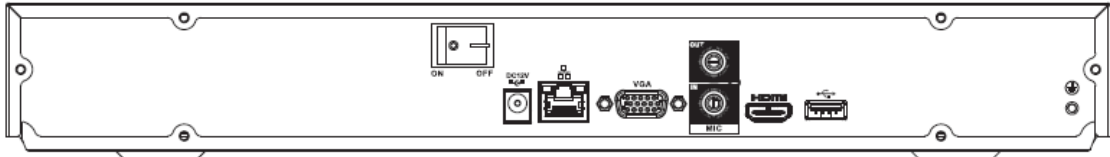

Figure 2-36

The NVR22-P-S2 series rear panel is shown as below. See Figure 2-37.

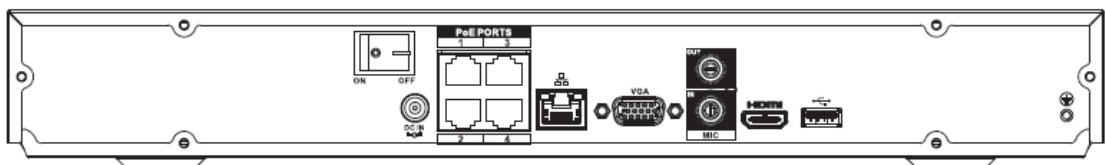

Figure 2-37

The NVR22-8P-S2 series rear panel is shown as below. See Figure 2-38.

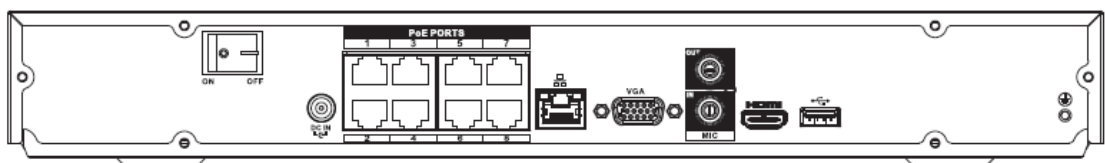





Figure 2-38

Please refer to the following sheet for detailed information.

Port Name	Connection	Function
	Power input port	Power socket. <ul style="list-style-type: none"> For NVR22-S2, input DC 12V/4A. For NVR22-P-S2, input DC 48V/1.5A. For NVR22-8P-S2, input DC 53V 120W.
	Network port	10M/100Mbps self-adaptive Ethernet port. Connect to the network cable.
	USB port	USB port. Connect to mouse, USB storage device and etc.
HDMI	High Definition Media Interface	High definition audio and video signal output port. It transmits uncompressed high definition video and multiple-channel data to the HDMI port of the display device. HDMI version is 1.4.
VGA	VGA video output port	VGA video output port. Output analog video signal. It can connect to the monitor to view analog video.
MIC IN	Audio input port	Bidirectional talk input port. It is to receive the analog audio signal output from the devices such as microphone, pickup.
MIC OUT	Audio output port	Audio output port. It is to output the analog audio signal to the devices such as the sound box. <ul style="list-style-type: none"> Bidirectional talk output. Audio output on 1-window video monitor. Audio output on 1-window video playback.
	GND	Ground end
PoE PORTS	PoE port	Built-in switch. Support PoE function. For PoE series product, you can use this port to provide power to the network camera.

2.2.10 NVR42/42N/42-P/42-8P/42-16P Series

The NVR42 series rear panel is shown as below. See Figure 2-39.

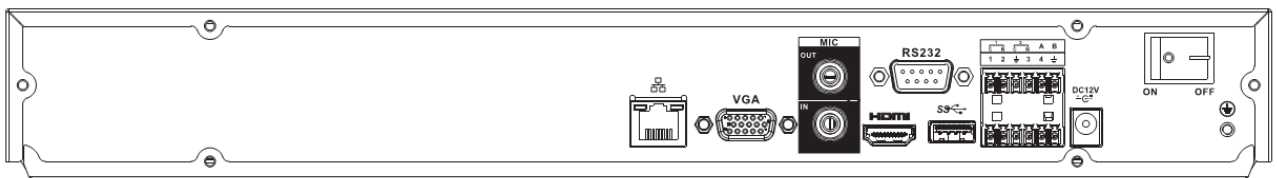

Figure 2-39

The NVR42N series rear panel is shown as below. See Figure 2-40.

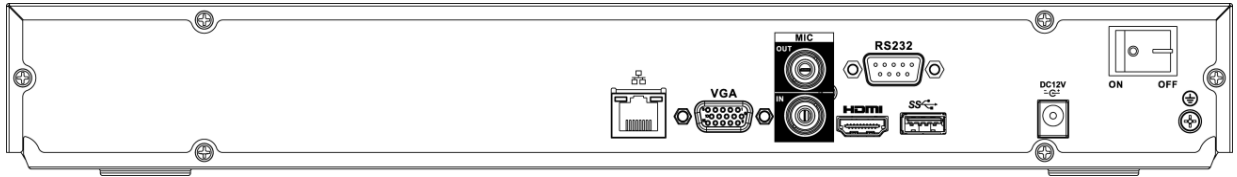

Figure 2-40

The NVR42-P series rear panel is shown as below. See Figure 2-41.

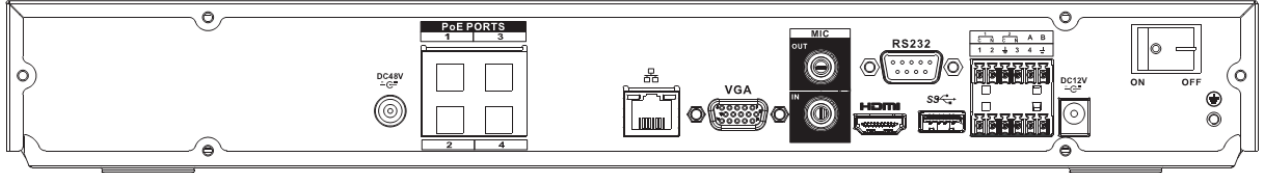

Figure 2-41

The NVR42-8P series rear panel is shown as below. See Figure 2-42.

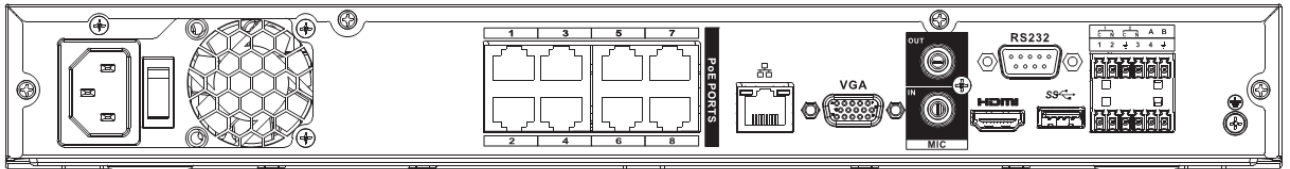

Figure 2-42

The NVR42-16P series rear panel is shown as below. See Figure 2-43.

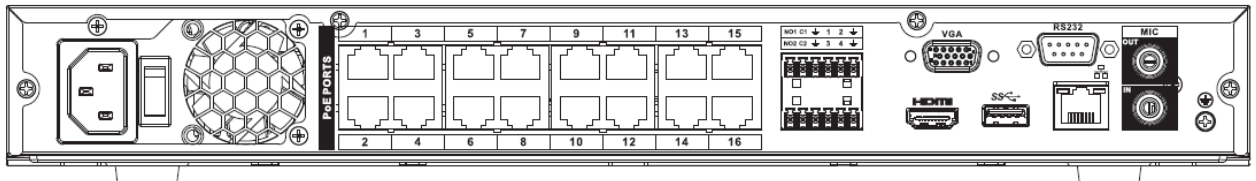





Figure 2-43

Please refer to the following sheet for detailed information.

Name	Function	
	Power switch	Power on/off button.
	Power input port	Input DC 12V/5A. For NVR42 series product only.
		Switch power port. Input DC 48//1.04A. For NVR42-P series product only.
		Input AC 100~240V. For NVR42-8P/42-16P series product only.

Name		Function
MIC IN	Audio input port	Bidirectional talk input port. It is to receive the analog audio signal output from the devices such as microphone, pickup.
MIC OUT	Audio output port	Audio output port. It is to output the analog audio signal to the devices such as the sound box. <ul style="list-style-type: none"> ● Bidirectional talk output. ● Audio output on 1-window video monitor. ● Audio output on 1-window video playback.
1~4	Alarm input port 1~4	<ul style="list-style-type: none"> ● There are two types; NO (normal open)/NC (normal close). ● When your alarm input device is using external power, please make sure the device and the NVR have the same ground.
	GND	Alarm input ground port.
N1, N2 C1, C2	Alarm output port 1~2	<ul style="list-style-type: none"> ● 2 groups of alarm output ports. (Group 1: port NO1~C1, Group 2: port NO2~C2). Output alarm signal to the alarm device. Please make sure there is power to the external alarm device. ● NO: Normal open alarm output port. ● C: Alarm output public end.
A	RS-485 communication port	RS485_A port. It is the cable A. You can connect to the control devices such as speed dome PTZ.
B		RS485_B. It is the cable B. You can connect to the control devices such as speed dome PTZ.
	Network port	10M/100M/1000Mbps self-adaptive Ethernet port. Connect to the network cable.
	 USB2.0 port	USB2.0 port. Connect to mouse, USB storage device, USB burner and etc.
RS-232	RS-232 debug COM.	It is for general COM debug to configure IP address or transfer transparent COM data.
HDMI	High Definition Media Interface	High definition audio and video signal output port. It transmits uncompressed high definition video and multiple-channel data to the HDMI port of the display device. HDMI version is 1.4.
VGA	VGA video output port	VGA video output port. Output analog video signal. It can connect to the monitor to view analog video.

Name		Function
PoE PORTS	/	Bult-in Switch. Support PoE. The 4 PoE series product supports total 48V 50W. The 8 PoE series product supports total 48V 120W. The 16 PoE series product supports total 120W. One PoE port max supports 15W.

2.2.11 NVR42-4K/52-4KS2/52-8P-4KS2/52-16P-4KS2 Series

The NVR42-4K/52-4KS2 series rear panel is shown as below. See Figure 2-44.

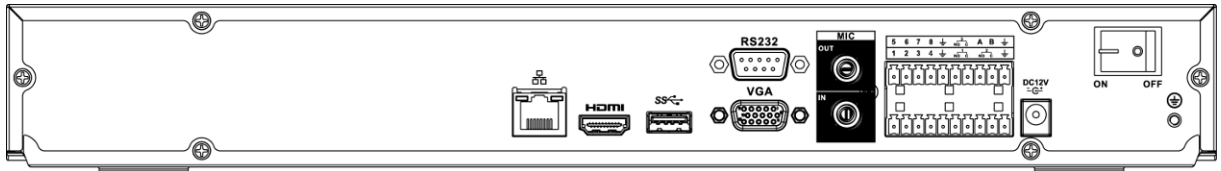

Figure 2-44

The NVR52-8P-4KS2 series rear panel is shown as below. See Figure 2-45.

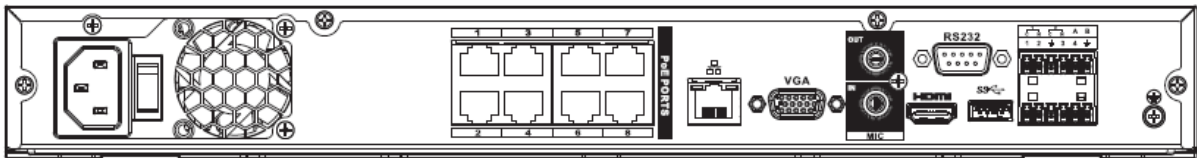

Figure 2-45

The NVR52-16P-4KS2 series rear panel is shown as below. See Figure 2-46.

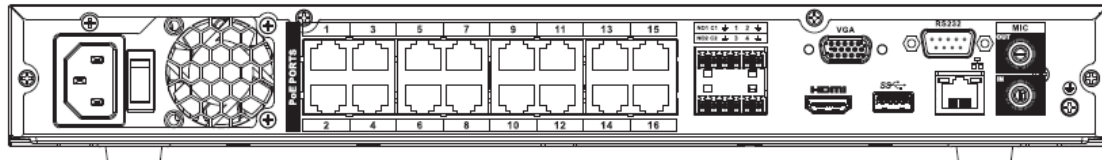



Figure 2-46

Please refer to the following sheet for detailed information.

Icon	Port Name	Function
	Network port	10M/100M/1000Mbps self-adaptive Ethernet port. Connect to the network cable.
HDMI	High Definition Media Interface	High definition audio and video signal output port. It transmits uncompressed high definition video and multiple-channel data to the HDMI port of the display device. HDMI version is 1.4.
	USB3.0 port	USB3.0 port. Connect to mouse, USB storage device, USB burner and etc.

Icon	Port Name	Function
RS-232	RS-232 debug COM.	It is for general COM debug to configure IP address or transfer transparent COM data.
VGA	VGA video output port	VGA video output port. Output analog video signal. It can connect to the monitor to view analog video.
MIC IN	Audio input port	Bidirectional talk input port. It is to receive the analog audio signal output from the devices such as microphone, pickup.
MIC OUT	Audio output port	Audio output port. It is to output the analog audio signal to the devices such as the sound box. <ul style="list-style-type: none"> ● Bidirectional talk output. ● Audio output on 1-window video monitor. ● Audio output on 1-window video playback.
1~8	Alarm input port 1~8	<ul style="list-style-type: none"> ● There are two groups. The first group is from port 1 to port 4; the second group is from port 5 to port 8. They are to receive the signal from the external alarm source. There are two types; NO (normal open)/NC (normal close). ● When your alarm input device is using external power, please make sure the device and the NVR have the same ground.
	GND	Alarm input ground port.
NO1~NO3	Alarm output port 1~3	<ul style="list-style-type: none"> ● 3 groups of alarm output ports. (Group 1: port NO1 ~ C1, Group 2: port NO2 ~ C2, Group 3: port NO3 ~ C3). Output alarm signal to the alarm device. Please make sure there is power to the external alarm device. ● NO: Normal open alarm output port. ● C: Alarm output public end.
C1~C3		
A	RS-485 communication port	RS485_A port. It is the cable A. You can connect to the control devices such as speed dome PTZ.
B		RS485_B. It is the cable B. You can connect to the control devices such as speed dome PTZ.
	Power input port	Input DC 12V/4A.
Power switch	/	Power on/off button.
PoE PORTS	/	Built-in Switch. Support PoE.. The 8 PoE series product supports total 130W. The 16 PoE series product supports total 130W.

2.2.12 NVR42-8P-4K Series

The NVR42-8P-4K series rear panel is shown as below. See Figure 2-47.

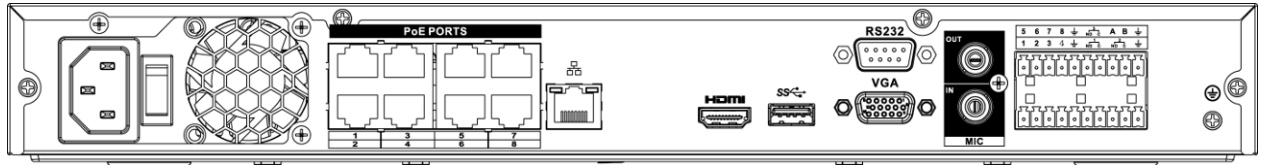

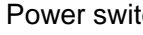



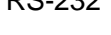





Figure 2-47

Please refer to the following sheet for detailed information.

Icon	Port Name	Function
	/	Input AC 220V.
	/	Power on/off button.
	PoE port	Built-in Switch, support PoE. The PoE PORTS can provide power to the network camera. The 8 PoE ports series product can support 48V 120W.
	Network port	10M/100M/1000Mbps self-adaptive Ethernet port. Connect to the network cable.
	High Definition Media Interface	High definition audio and video signal output port. It transmits uncompressed high definition video and multiple-channel data to the HDMI port of the display device. HDMI version is 1.4.
	USB3.0 port	USB3.0 port. Connect to mouse, USB storage device, USB burner and etc.
	RS-232 debug COM.	It is for general COM debug to configure IP address or transfer transparent COM data.
	VGA video output port	VGA video output port. Output analog video signal. It can connect to the monitor to view analog video.
	Audio input port	Bidirectional talk input port. It is to receive the analog audio signal output from the devices such as microphone, pickup.
	Audio output port	Audio output port. It is to output the analog audio signal to the devices such as the sound box. <ul style="list-style-type: none"> ● Bidirectional talk output. ● Audio output on 1-window video monitor. ● Audio output on 1-window video playback.
	Alarm input port 1~4	<ul style="list-style-type: none"> ● They are to receive the signal from the external alarm source. There are two types; NO (normal open)/NC (normal close). ● When your alarm input device is using external power, please make sure the device and the NVR have the same ground.

Icon	Port Name	Function
	GND	Alarm input ground port.
N1,N2	Alarm output port 1~2	<ul style="list-style-type: none"> 2 groups of alarm output ports. (group 1: port NO1~C1, group 2: port NO2~C2) . Output alarm signal to the alarm device. Please make sure there is power to the external alarm device. NO: Normal open alarm output port. C: Alarm output public end.
C1~C2		
A	RS-485 communication port	RS485_A port. It is the cable A. You can connect to the control devices such as speed dome PTZ.
B		RS485_B.It is the cable B. You can connect to the control devices such as speed dome PTZ.

2.2.13 NVR44/44-8P/44-16P Series

The NVR44 series rear panel is shown as below. See Figure 2-48.

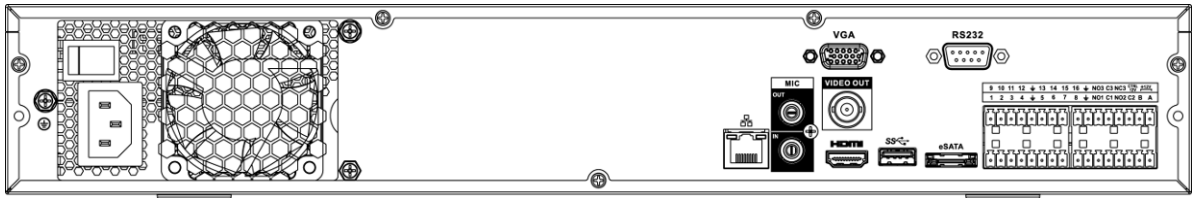

Figure 2-48

The NVR44-8P series rear panel is shown as below. See Figure 2-49.

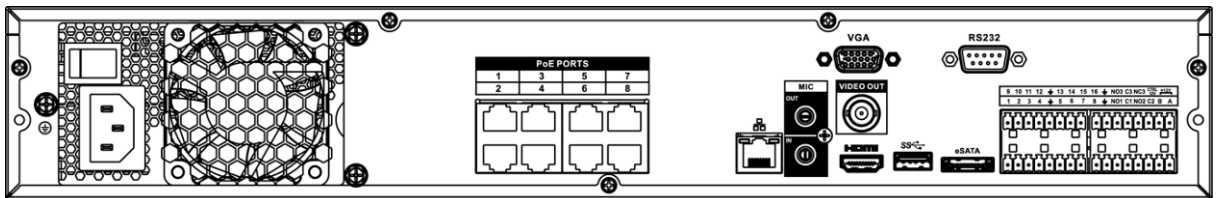

Figure 2-49

The NVR44-16P series rear panel is shown as below. See Figure 2-50.

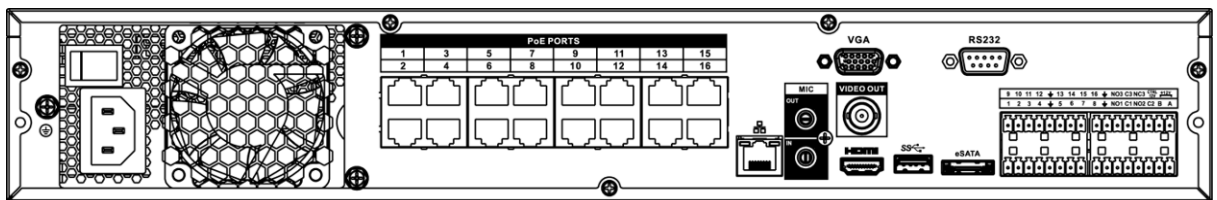





Figure 2-50

Please refer to the following sheet for detailed information.

Name		Function
Power switch	/	Power on-off button
Power input port	/	Input AC 100~240V.

Name		Function
MIC IN	Audio input port	Bidirectional talk input port. It is to receive the analog audio signal output from the devices such as microphone, pickup.
MIC OUT	Audio output port	Audio output port. It is to output the analog audio signal to the devices such as the sound box. <ul style="list-style-type: none"> ● Bidirectional talk output. ● Audio output on 1-window video monitor. ● Audio output on 1-window video playback.
VIDEO OUT	Video output port	CVBS output
1~16	Alarm input port 1~16	<ul style="list-style-type: none"> ● There are four groups. The first group is from port 1 to port 4, the second group is from port 5 to port 8, the third group is from 9 to 12, and the fourth group is from 13 to 16. They are to receive the signal from the external alarm source. There are two types; NO (normal open)/NC (normal close). ● When your alarm input device is using external power, please make sure the device and the NVR have the same ground.
	Video output port	CVBS output
NO1~NO5 C1~C5 NC5	Alarm output port 1~5	<ul style="list-style-type: none"> ● 5 groups of alarm output ports. (Group 1: port NO1~C1, Group 2: port NO2~C2, Group 3: port NO3~C3, Group 4: port NO4~C4, Group 5: port NO5, C5, NC5). Output alarm signal to the alarm device. Please make sure there is power to the external alarm device. ● NO: Normal open alarm output port. ● C: Alarm output public end. ● NC: Normal close alarm output port.
A	RS-485 communication port	RS485_A port. It is the cable A. You can connect to the control devices such as speed dome PTZ.
B		RS485_B. It is the cable B. You can connect to the control devices such as speed dome PTZ.
CTRL 12V	/	Controller 12V power output. It is to control the on-off alarm relay output. It can be used to control the device alarm output. At the same time, it can also be used as the power input source of some devices such as the alarm detector.
+12V	/	+12V power output port. It can provide the power to some peripheral devices such as the camera or the alarm device. Please note the supplying power shall be below 1A.
	Network port	10M/100M/1000Mbps self-adaptive Ethernet port. Connect to the network cable.

Name		Function
eSATA	eSATA port	External SATA port. It can connect to the device of the SATA port. Please jump the HDD when there is peripheral connected HDD.
	USB2.0 port	USB2.0 port. Connect to mouse, USB storage device, USB burner and etc.
RS-232	RS232 debug COM.	It is for general COM debug to configure IP address or transfer transparent COM data.
HDMI	High Definition Media Interface	High definition audio and video signal output port. It transmits uncompressed high definition video and multiple-channel data to the HDMI port of the display device. HDMI version is 1.3
VGA	VGA video output port	VGA video output port. Output analog video signal. It can connect to the monitor to view analog video.
PoE PORTS	8 PoE ports	Built-in Switch. Support PoE. The 8 PoE ports series products supports total 48V 120W power. One PoE port max supports 15W.
PoE PORTS	16 PoE ports	Built-in Switch. Support PoE. The 16 PoE ports series products supports total 150W power. One PoE port max supports 15W.

2.2.14 NVR44-4K/48-4K/54-4KS2/58-4KS2/54-16P-4KS2/58-16P-4KS2 Series

The NVR44-4K/NVR48-4K/ NVR54-4KS2/NVR58-4KS2 series rear panel is shown as below. See Figure 2-51.

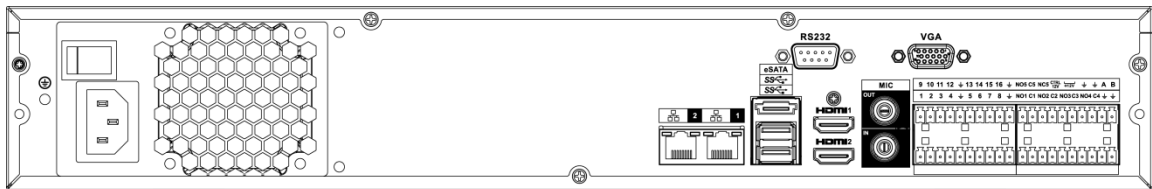

Figure 2-51

The NVR54-16P-4KS2/NVR58-16P-4KS2 series rear panel is shown as below. See Figure 2-52.

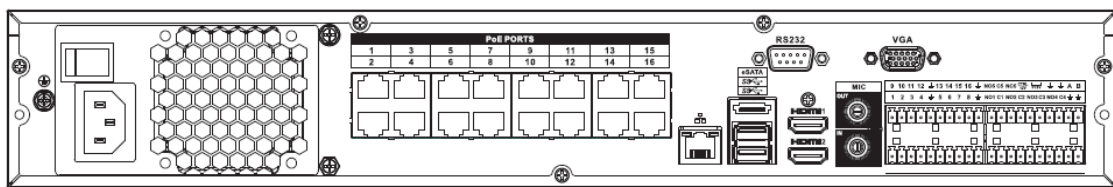







Figure 2-52

Please refer to the following sheet for detailed information.

Name	Function
------	----------

Name		Function
	Power switch	Power on-off button
	Power input port	Input AC 100~240V.
	Network port	10M/100M/1000Mbps self-adaptive Ethernet port. Connect to the network cable.
eSATA	eSATA port	External SATA port. It can connect to the device of the SATA port. Please jump the HDD when there is peripheral connected HDD.
	USB3.0 port	USB3.0 port. Connect to mouse, USB storage device, USB burner and etc.
HDMI	High Definition Media Interface	High definition audio and video signal output port. It transmits uncompressed high definition video and multiple-channel data to the HDMI port of the display device. HDMI version is 1.4b.
MIC IN	Audio input port	Bidirectional talk input port. It is to receive the analog audio signal output from the devices such as microphone, pickup.
MIC OUT	Audio output port	Audio output port. It is to output the analog audio signal to the devices such as the sound box. <ul style="list-style-type: none"> ● Bidirectional talk output. ● Audio output on 1-window video monitor. ● Audio output on 1-window video playback.
1~16	Alarm input port 1~16	<ul style="list-style-type: none"> ● There are four groups. The first group is from port 1 to port 4, the second group is from port 5 to port 8, the third group is from 9 to 12, and the fourth group is from 13 to 16. They are to receive the signal from the external alarm source. There are two types; NO (normal open)/NC (normal close). ● When your alarm input device is using external power, please make sure the device and the NVR have the same ground.
	Ground	Alarm input ground end.
NO1~NO5	Alarm output port 1~5	<ul style="list-style-type: none"> ● 5 groups of alarm output ports. (Group 1: port NO1~C1, Group 2: port NO2~C2, Group 3: port NO3~C3, Group 4: port NO4~C4, Group 5: port NO5, C5, NC5). Output alarm signal to the alarm device. Please make sure there is power to the external alarm device. ● NO: Normal open alarm output port. ● C: Alarm output public end. ● NC: Normal close alarm output port.
C1~C5		
NC5		

Name		Function
A	RS-485 communication port	RS485_A port. It is the cable A. You can connect to the control devices such as speed dome PTZ.
B		RS485_B.It is the cable B. You can connect to the control devices such as speed dome PTZ.
CTRL 12V	/	Controller 12V power output. It is to control the on-off alarm relay output. It can be used to control the device alarm output. At the same time, it can also be used as the power input source of some devices such as the alarm detector.
+12V	/	+12V power output port. It can provide the power to some peripheral devices such as the camera or the alarm device. Please note the supplying power shall be below 1A.
RS-232	RS232 debug COM.	It is for general COM debug to configure IP address or transfer transparent COM data.
VGA	VGA video output port	VGA video output port. Output analog video signal. It can connect to the monitor to view analog video.
PoE PORTS	/	Bult-in Switch. Support PoE. The 16 PoE series product supports total 150W.

2.2.15 NVR48/48-16P Series

The NVR48 series rear panel is shown as below. See Figure 2-53.

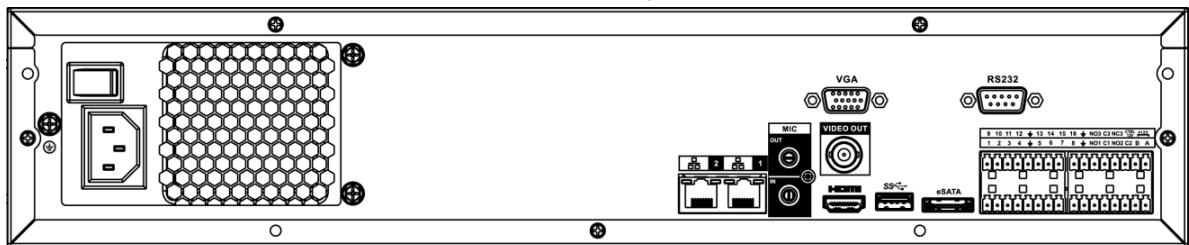

Figure 2-53

The NVR48-16P series rear panel is shown as below. See Figure 2-54.

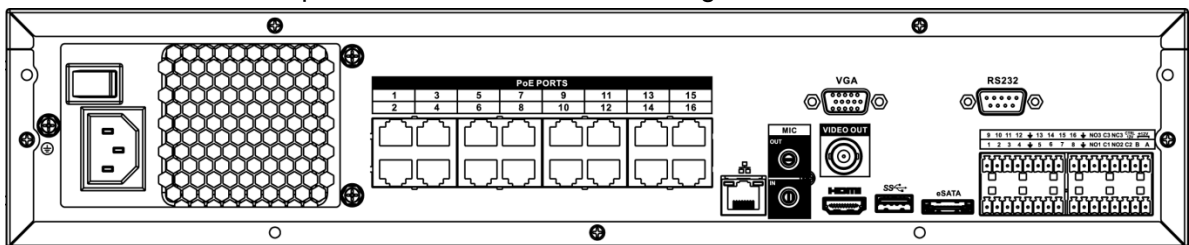





Figure 2-54

Please refer to the following sheet for detailed information.

Name	Function
------	----------

Name		Function
Power switch	/	Power on-off button
Power input port	/	Input AC 100~240V.
MIC IN	Audio input port	Bidirectional talk input port. It is to receive the analog audio signal output from the devices such as microphone, pickup.
MIC OUT	Audio output port	Audio output port. It is to output the analog audio signal to the devices such as the sound box. <ul style="list-style-type: none"> ● Bidirectional talk output. ● Audio output on 1-window video monitor. ● Audio output on 1-window video playback.
VIDEO OUT	Video output port	CVBS output.
1~16	Alarm input port 1~16	<ul style="list-style-type: none"> ● There are four groups. The first group is from port 1 to port 4, the second group is from port 5 to port 8, the third group is from 9 to 12, and the fourth group is from 13 to 16. They are to receive the signal from the external alarm source. There are two types; NO (normal open)/NC (normal close). ● When your alarm input device is using external power, please make sure the device and the NVR have the same ground.
	GND	Alarm input ground port.
NO1~NO5 C1~C5 NC5	Alarm output port 1~5	<ul style="list-style-type: none"> ● 5 groups of alarm output ports. (Group 1: port NO1~C1, Group 2: port NO2~C2, Group 3: port NO3~C3, Group 4: port NO4~C4, Group 5: port NO5, C5, NC5). Output alarm signal to the alarm device. Please make sure there is power to the external alarm device. ● NO: Normal open alarm output port. ● C: Alarm output public end. ● NC: Normal close alarm output port.
A	RS-485 communication port	RS485_A port. It is the cable A. You can connect to the control devices such as speed dome PTZ.
B		RS485_B. It is the cable B. You can connect to the control devices such as speed dome PTZ.
CTRL 12V	/	Controller 12V power output. It is to control the on-off alarm relay output. It can be used to control the device alarm output. At the same time, it can also be used as the power input source of some devices such as the alarm detector.

Name		Function
+12V	/	+12V power output port. It can provide the power to some peripheral devices such as the camera or the alarm device. Please note the supplying power shall be below 1A.
	Network port	One 10M/100M/1000Mbps self-adaptive Ethernet port. Connect to the network cable.
eSATA	eSATA port	External SATA port. It can connect to the device of the SATA port. Please jump the HDD when there is peripheral connected HDD.
	USB2.0 port	USB2.0 port. Connect to mouse, USB storage device, USB burner and etc.
RS-232	RS-232 debug COM.	It is for general COM debug to configure IP address or transfer transparent COM data.
HDMI	High Definition Media Interface	High definition audio and video signal output port. It transmits uncompressed high definition video and multiple-channel data to the HDMI port of the display device. HDMI version is 1.3.
VGA	VGA video output port	VGA video output port. Output analog video signal. It can connect to the monitor to view analog video.
PoE PORTS	16 PoE ports	Built-in Switch. Support PoE. The 16 PoE ports series products supports total 150W power. One PoE port max supports 15W.

2.2.16 NVR72 Series

The NVR72 series rear panel is shown as below. See Figure 2-55.

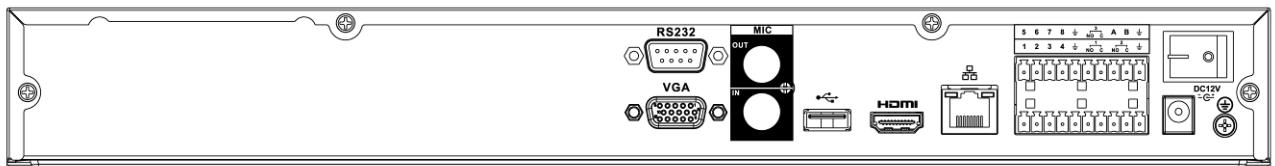





Figure 2-55

Please refer to the following sheet for detailed information.

Name		Function
	USB2.0 port	USB2.0 port. Connect to mouse, USB storage device, USB burner and etc.
	Network port	10M/100M/1000Mbps self-adaptive Ethernet port. Connect to the network cable.
RS-232	RS-232 debug COM.	It is for general COM debug to configure IP address or transfer transparent COM data.

Name		Function
HDMI	High Definition Media Interface	High definition audio and video signal output port. It transmits uncompressed high definition video and multiple-channel data to the HDMI port of the display device. HDMI version is 1.4.
VGA	VGA video output port	VGA video output port. Output analog video signal. It can connect to the monitor to view analog video.
MIC IN	Audio input port	Bidirectional talk input port. It is to receive the analog audio signal output from the devices such as microphone, pickup.
MIC OUT	Audio output port	Audio output port. It is to output the analog audio signal to the devices such as the sound box. <ul style="list-style-type: none"> ● Bidirectional talk output. ● Audio output on 1-window video monitor. ● Audio output on 1-window video playback.
1~8	Alarm input port 1~8	<ul style="list-style-type: none"> ● There are two groups. The first group is from port 1 to port 4; the second group is from port 5 to port 8. They are to receive the signal from the external alarm source. There are two types; NO (normal open)/NC (normal close). ● When your alarm input device is using external power, please make sure the device and the NVR have the same ground.
	GND	Alarm input ground port.
NO1~NO3	Alarm output port 1~3	<ul style="list-style-type: none"> ● 3 groups of alarm output ports. (Group 1: port NO1 ~ C1, Group 2: port NO2 ~ C2, Group 3: port NO3 ~ C3)).Output alarm signal to the alarm device. Please make sure there is power to the external alarm device. ● NO: Normal open alarm output port. ● C: Alarm output public end.
C1~C3		
A	RS-485 communication port	RS485_A port. It is the cable A. You can connect to the control devices such as speed dome PTZ.
B		RS485_B. It is the cable B. You can connect to the control devices such as speed dome PTZ.
	Power input port	Input DC 12V/5A.
Power switch	/	Power on/off button.

2.2.17 NVR72-8P Series

The NVR72-8P series rear panel is shown as below. See Figure 2-56.

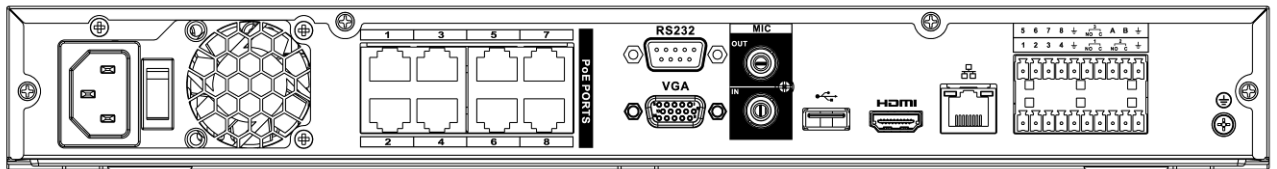





Figure 2-56

Please refer to the following sheet for detailed information.

Name		Function
	USB2.0 port	USB2.0 port. Connect to mouse, USB storage device, USB burner and etc.
	Network port	10M/100M/1000Mbps self-adaptive Ethernet port. Connect to the network cable.
RS-232	RS-232 debug COM.	It is for general COM debug to configure IP address or transfer transparent COM data.
HDMI	High Definition Media Interface	High definition audio and video signal output port. It transmits uncompressed high definition video and multiple-channel data to the HDMI port of the display device. HDMI version is 1.4.
VGA	VGA video output port	VGA video output port. Output analog video signal. It can connect to the monitor to view analog video.
1~8	Alarm input port 1~8	<ul style="list-style-type: none"> There are two groups. The first group is from port 1 to port 4; the second group is from port 5 to port 8. They are to receive the signal from the external alarm source. There are two types; NO (normal open)/NC (normal close). When your alarm input device is using external power, please make sure the device and the NVR have the same ground.
	GND	Alarm input ground port.
NO1~NO3	Alarm output port 1~3	<ul style="list-style-type: none"> 3 groups of alarm output ports. (Group 1: port NO1 ~ C1, Group 2: port NO2 ~ C2, Group 3: port NO3 ~ C3). Output alarm signal to the alarm device. Please make sure there is power to the external alarm device. NO: Normal open alarm output port. C: Alarm output public end.
C1~C3		
A	RS-485 communication port	RS485_A port. It is the cable A. You can connect to the control devices such as speed dome PTZ.
B		RS485_B. It is the cable B. You can connect to the control devices such as speed dome PTZ.

Name		Function
	Power input port	Input AC 100~240V.
Power switch	/	Power on-off button.
PoE PORTS	/	Built-in Switch. Support PoE. The 8 PoE series product supports total 48V 120W. One PoE port max supports 15W.
MIC IN	Audio input port	Bidirectional talk input port. It is to receive the analog audio signal output from the devices such as microphone, pickup.
MIC OUT	Audio output port	Audio output port. It is to output the analog audio signal to the devices such as the sound box. <ul style="list-style-type: none"> ● Bidirectional talk output. ● Audio output on 1-window video monitor. ● Audio output on 1-window video playback.

2.2.18 NVR74 Series

The NVR74 series rear panel is shown as below. See Figure 2-57.

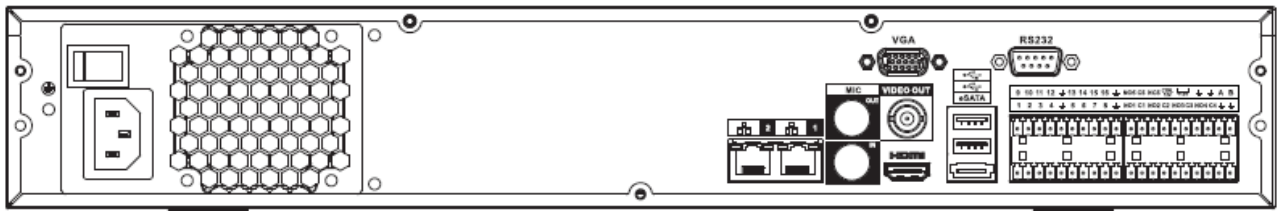







Figure 2-57

Please refer to the following sheet for detailed information.

Icon	Name	Function
	Power switch	Power on/off button.
	Power input port	Input AC 100~240V.
MIC IN	Audio input port	Bidirectional talk input port. It is to receive the analog audio signal output from the devices such as microphone, pickup.
MIC OUT	Audio output port	Audio output port. It is to output the analog audio signal to the devices such as the sound box. <ul style="list-style-type: none"> ● Bidirectional talk output. ● Audio output on 1-window video monitor. ● Audio output on 1-window video playback.

VIEDEO OUT	Video output port	CVBS output.
HDMI	High Definition Media Interface	High definition audio and video signal output port. It transmits uncompressed high definition video and multiple-channel data to the HDMI port of the display device. HDMI version is 1.3.
1~16	Alarm input port 1~16	<ul style="list-style-type: none"> There are four groups. The first group is from port 1 to port 4, the second group is from port 5 to port 8, the third group is from 9 to 12, and the fourth group is from 13 to 16. They are to receive the signal from the external alarm source. There are two types; NO (normal open)/NC (normal close). When your alarm input device is using external power, please make sure the device and the NVR have the same ground.
	GND	Alarm input ground port.
NO1~NO5 C1~C5 NC5	Alarm output port 1~5	<ul style="list-style-type: none"> 5 groups of alarm output ports. (Group 1: port NO1~C1, Group 2: port NO2~C2, Group 3: port NO3~C3, Group 4: port NO4~C4, Group 5: port NO5, C5, NC5). Output alarm signal to the alarm device. Please make sure there is power to the external alarm device. NO: Normal open alarm output port. C: Alarm output public end. NC: Normal close alarm output port.
A	RS-485 communication port	RS485_A port. It is the cable A. You can connect to the control devices such as speed dome PTZ.
B		RS485_B. It is the cable B. You can connect to the control devices such as speed dome PTZ.
CTRL 12V	/	Controller 12V power output. It is to control the on-off alarm relay output. It can be used to control the device alarm output. At the same time, it can also be used as the power input source of some devices such as the alarm detector.
+12V	/	+12V power output port. It can provide the power to some peripheral devices such as the camera or the alarm device. Please note the supplying power shall be below 1A.
	Network port	One 10M/100M/1000Mbps self-adaptive Ethernet port. Connect to the network cable.
eSATA	eSATA port	External SATA port. It can connect to the device of the SATA port. Please jump the HDD when there is peripheral connected HDD.
	USB2.0 port	USB2.0 port. Connect to mouse, USB storage device, USB burner and etc.

RS-232	RS-232 debug COM.	It is for general COM debug to configure IP address or transfer transparent COM data.
VGA	VGA video output port	VGA video output port. Output analog video signal. It can connect to the monitor to view analog video.

2.2.19 NVR74-8P/74-16P Series

The NVR74-8P series rear panel is shown as below. See Figure 2-58.

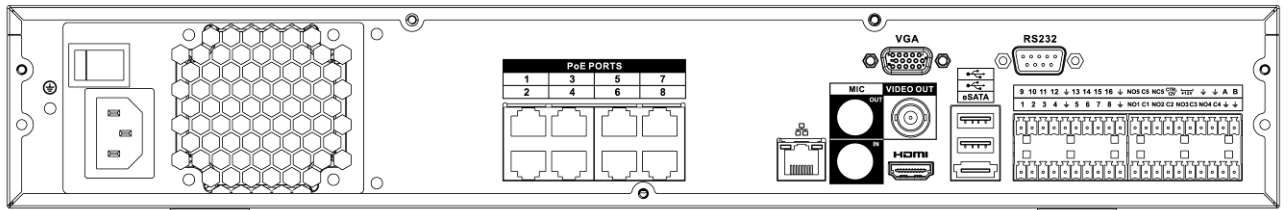

Figure 2-58

The NVR74-16P series rear panel is shown as below. See Figure 2-59.

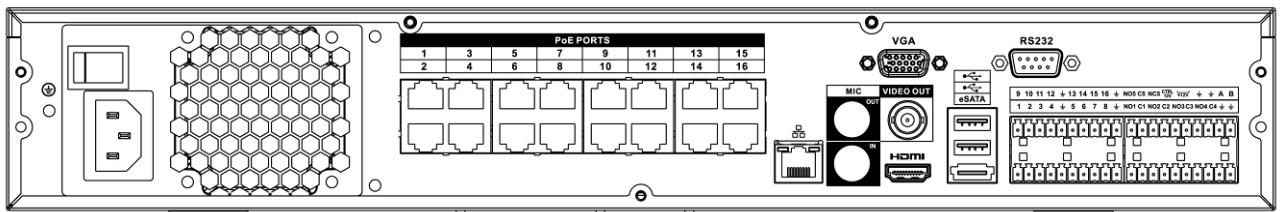





Figure 2-59

Please refer to the following sheet for detailed information.

Port Name		Function
Power switch	/	Power on-off button
Power input port	/	Input AC 100~240V.
MIC IN	Audio input port	Bidirectional talk input port. It is to receive the analog audio signal output from the devices such as microphone, pickup.
MIC OUT	Audio output port	Audio output port. It is to output the analog audio signal to the devices such as the sound box. <ul style="list-style-type: none"> ● Bidirectional talk output. ● Audio output on 1-window video monitor. ● Audio output on 1-window video playback.
VIEDEO OUT	Video output port	CVBS output

Port Name		Function
1~16	Alarm input port 1~16	<ul style="list-style-type: none"> There are four groups. The first group is from port 1 to port 4, the second group is from port 5 to port 8, the third group is from 9 to 12, and the fourth group is from 13 to 16. They are to receive the signal from the external alarm source. There are two types; NO (normal open)/NC (normal close). When your alarm input device is using external power, please make sure the device and the NVR have the same ground.
	GND	Alarm input ground port.
NO1~NO5 C1~C5 NC5	Alarm output port 1~5	<ul style="list-style-type: none"> 5 groups of alarm output ports. (Group 1: port NO1~C1, Group 2: port NO2~C2, Group 3: port NO3~C3, Group 4: port NO4~C4, Group 5: port NO5, C5, NC5). Output alarm signal to the alarm device. Please make sure there is power to the external alarm device. NO: Normal open alarm output port. C: Alarm output public end. NC: Normal close alarm output port.
A	RS-485 communication port	RS485_A port. It is the cable A. You can connect to the control devices such as speed dome PTZ.
B		RS485_B. It is the cable B. You can connect to the control devices such as speed dome PTZ.
CTRL 12V	/	Controller 12V power output. It is to control the on-off alarm relay output. It can be used to control the device alarm output. At the same time, it can also be used as the power input source of some devices such as the alarm detector.
+12V	/	+12V power output port. It can provide the power to some peripheral devices such as the camera or the alarm device. Please note the supplying power shall be below 1A.
	Network port	10M/100M/1000Mbps self-adaptive Ethernet port. Connect to the network cable.
eSATA	eSATA port	External SATA port. It can connect to the device of the SATA port. Please jump the HDD when there is peripheral connected HDD.
	USB2.0 port	USB2.0 port. Connect to mouse, USB storage device, USB burner and etc.
RS-232	RS232 debug COM.	It is for general COM debug to configure IP address or transfer transparent COM data.

Port Name		Function
HDMI	High Definition Media Interface	High definition audio and video signal output port. It transmits uncompressed high definition video and multiple-channel data to the HDMI port of the display device. HDMI version is 1.3
VGA	VGA video output port	VGA video output port. Output analog video signal. It can connect to the monitor to view analog video.
PoE PORTS	8 PoE ports	Built-in Switch. Support PoE. The 8 PoE ports series products supports total 48V 120W power. One PoE port max supports 15W.
PoE PORTS	16 PoE ports	Built-in Switch. Support PoE. The 16 PoE ports series products supports total 150W power. One PoE port max supports 15W.

2.2.20 NVR78 Series

The NVR78 series rear panel is shown as below. See Figure 2-60.

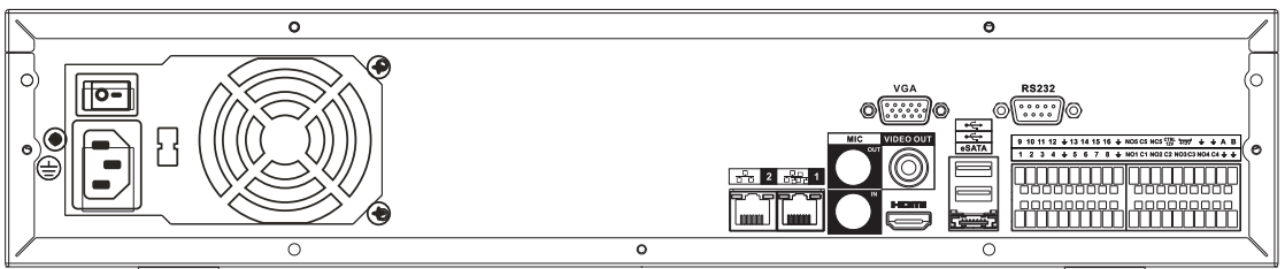





Figure 2-60

Please refer to the following sheet for detailed information.

Port Name		Function
Power switch	/	Power on-off button
Power input port	/	Input AC 100~240V.
MIC IN	Audio input port	Bidirectional talk input port. It is to receive the analog audio signal output from the devices such as microphone, pickup.
MIC OUT	Audio output port	Audio output port. It is to output the analog audio signal to the devices such as the sound box. <ul style="list-style-type: none"> ● Bidirectional talk output. ● Audio output on 1-window video monitor. ● Audio output on 1-window video playback.
VIDEO OUT	Video output port	CVBS output

Port Name		Function
1~16	Alarm input port 1~16	<ul style="list-style-type: none"> There are four groups. The first group is from port 1 to port 4, the second group is from port 5 to port 8, the third group is from 9 to 12, and the fourth group is from 13 to 16. They are to receive the signal from the external alarm source. There are two types; NO (normal open)/NC (normal close). When your alarm input device is using external power, please make sure the device and the NVR have the same ground.
	GND	Alarm input ground port.
NO1~NO5 C1~C5 NC5	Alarm output port 1~5	<ul style="list-style-type: none"> 5 groups of alarm output ports. (Group 1: port NO1~C1, Group 2: port NO2~C2, Group 3: port NO3~C3, Group 4: port NO4~C4, Group 5: port NO5, C5, NC5). Output alarm signal to the alarm device. Please make sure there is power to the external alarm device. NO: Normal open alarm output port. C: Alarm output public end. NC: Normal close alarm output port.
A	RS-485 communication port	RS485_A port. It is the cable A. You can connect to the control devices such as speed dome PTZ.
B		RS485_B. It is the cable B. You can connect to the control devices such as speed dome PTZ.
CTRL 12V	/	Controller 12V power output. It is to control the on-off alarm relay output. It can be used to control the device alarm output. At the same time, it can also be used as the power input source of some devices such as the alarm detector.
+12V	/	+12V power output port. It can provide the power to some peripheral devices such as the camera or the alarm device. Please note the supplying power shall be below 1A.
	Network port	10M/100M/1000Mbps self-adaptive Ethernet port. Connect to the network cable.
eSATA	eSATA port	External SATA port. It can connect to the device of the SATA port. Please jump the HDD when there is peripheral connected HDD.
	USB2.0 port	USB2.0 port. Connect to mouse, USB storage device, USB burner and etc.
RS-232	RS-232 debug COM.	It is for general COM debug to configure IP address or transfer transparent COM data.

Port Name		Function
HDMI	High Definition Media Interface	High definition audio and video signal output port. It transmits uncompressed high definition video and multiple-channel data to the HDMI port of the display device. HDMI version is 1.3.
VGA	VGA video output port	VGA video output port. Output analog video signal. It can connect to the monitor to view analog video.

2.2.21 NVR78-16P Series

The NVR78-16P series rear panel is shown as below. See Figure 2-61.

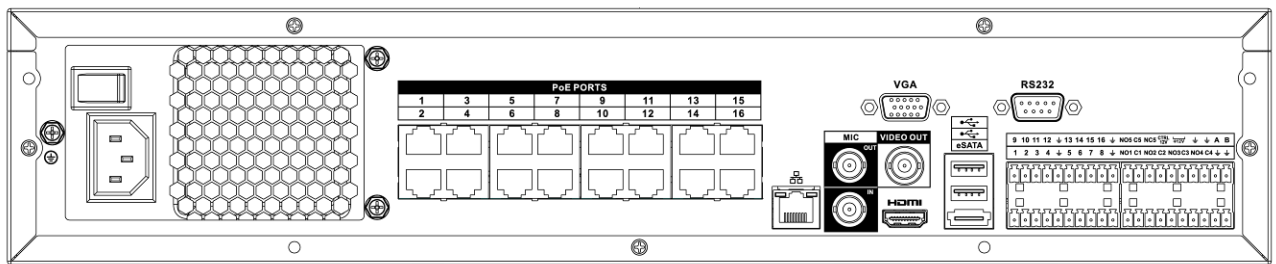





Figure 2-61

Please refer to the following sheet for detailed information.

Port Name		Function
Power switch	/	Power on-off button
Power input port	/	Input AC 100~240V.
MIC IN	Audio input port	Bidirectional talk input port. It is to receive the analog audio signal output from the devices such as microphone, pickup.
MIC OUT	Audio output port	Audio output port. It is to output the analog audio signal to the devices such as the sound box. <ul style="list-style-type: none"> ● Bidirectional talk output. ● Audio output on 1-window video monitor. ● Audio output on 1-window video playback.
VIDEO OUT	Video output port	CVBS output
1~16	Alarm input port 1~16	<ul style="list-style-type: none"> ● There are four groups. The first group is from port 1 to port 4, the second group is from port 5 to port 8, the third group is from 9 to 12, and the fourth group is from 13 to 16. They are to receive the signal from the external alarm source. There are two types; NO (normal open)/NC (normal close). ● When your alarm input device is using external power, please make sure the device and the NVR have the same ground.

Port Name		Function
	GND	Alarm input ground port.
NO1~NO5 C1~C5 NC5	Alarm output port 1~5	<ul style="list-style-type: none"> ● 5 groups of alarm output ports. (Group 1: port NO1~C1, Group 2: port NO2~C2, Group 3: port NO3~C3, Group 4: port NO4~C4, Group 5: port NO5, C5, NC5). Output alarm signal to the alarm device. Please make sure there is power to the external alarm device. ● NO: Normal open alarm output port. ● C: Alarm output public end. ● NC: Normal close alarm output port.
A	RS-485 communication port	RS485_A port. It is the cable A. You can connect to the control devices such as speed dome PTZ.
B		RS485_B. It is the cable B. You can connect to the control devices such as speed dome PTZ.
CTRL 12V	/	Controller 12V power output. It is to control the on-off alarm relay output. It can be used to control the device alarm output. At the same time, it can also be used as the power input source of some devices such as the alarm detector.
+12V	/	+12V power output port. It can provide the power to some peripheral devices such as the camera or the alarm device. Please note the supplying power shall be below 1A.
	Network port	10M/100M/1000Mbps self-adaptive Ethernet port. Connect to the network cable.
eSATA	eSATA port	External SATA port. It can connect to the device of the SATA port. Please jump the HDD when there is peripheral connected HDD.
	USB2.0 port	USB2.0 port. Connect to mouse, USB storage device, USB burner and etc.
RS-232	RS232 debug COM.	It is for general COM debug to configure IP address or transfer transparent COM data.
HDMI	High Definition Media Interface	High definition audio and video signal output port. It transmits uncompressed high definition video and multiple-channel data to the HDMI port of the display device. HDMI version is 1.3
VGA	VGA video output port	VGA video output port. Output analog video signal. It can connect to the monitor to view analog video.
PoE PORTS	16 PoE ports	Built-in Switch. Support PoE. The 16 PoE ports series products supports total 150W power. One PoE port max supports 15W.

2.2.22 NVR78-RH Series

The NVR78-RH series rear panel is shown as below. See Figure 2-62.

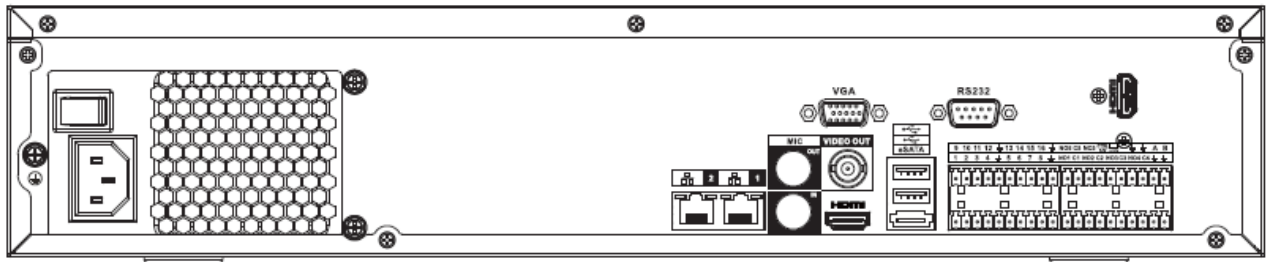





Figure 2-62

Please refer to the following sheet for detailed information.

Port Name		Function
Power switch	/	Power on-off button
Power input port	/	Input AC 100~240V.
MIC IN	Audio input port	Bidirectional talk input port. It is to receive the analog audio signal output from the devices such as microphone, pickup.
MIC OUT	Audio output port	Audio output port. It is to output the analog audio signal to the devices such as the sound box. <ul style="list-style-type: none"> ● Bidirectional talk output. ● Audio output on 1-window video monitor. ● Audio output on 1-window video playback.
VIDEO OUT	Video output port	CVBS output
1~16	Alarm input port 1~16	<ul style="list-style-type: none"> ● There are four groups. The first group is from port 1 to port 4, the second group is from port 5 to port 8, the third group is from 9 to 12, and the fourth group is from 13 to 16. They are to receive the signal from the external alarm source. There are two types; NO (normal open)/NC (normal close). ● When your alarm input device is using external power, please make sure the device and the NVR have the same ground.
	GND	Alarm input ground port.
NO1~NO5	Alarm output port 1~5	<ul style="list-style-type: none"> ● 5 groups of alarm output ports. (Group 1: port NO1~C1, Group 2: port NO2~C2, Group 3: port
C1~C5		

Port Name		Function
NC5		<p>NO3~C3, Group 4: port NO4~C4, Group 5: port NO5, C5, NC5).Output alarm signal to the alarm device. Please make sure there is power to the external alarm device.</p> <ul style="list-style-type: none"> ● NO: Normal open alarm output port. ● C: Alarm output public end. ● NC: Normal close alarm output port.
A	RS-485 communication port	RS485_A port. It is the cable A. You can connect to the control devices such as speed dome PTZ.
B		RS485_B.It is the cable B. You can connect to the control devices such as speed dome PTZ.
CTRL 12V	/	Controller 12V power output. It is to control the on-off alarm relay output. It can be used to control the device alarm output. At the same time, it can also be used as the power input source of some devices such as the alarm detector.
+12V	/	+12V power output port. It can provide the power to some peripheral devices such as the camera or the alarm device. Please note the supplying power shall be below 1A.
	Network port	10M/100M/1000Mbps self-adaptive Ethernet port. Connect to the network cable.
eSATA	eSATA port	External SATA port. It can connect to the device of the SATA port. Please jump the HDD when there is peripheral connected HDD.
	USB2.0 port	USB2.0 port. Connect to mouse, USB storage device, USB burner and etc.
RS-232	RS232 debug COM.	It is for general COM debug to configure IP address or transfer transparent COM data.
HDMI	High Definition Media Interface	High definition audio and video signal output port. It transmits uncompressed high definition video and multiple-channel data to the HDMI port of the display device. HDMI version is 1.3. The two HDMI ports to output video from different video sources.
VGA	VGA video output port	VGA video output port. Output analog video signal. It can connect to the monitor to view analog video.

2.2.23 NVR70 Series

The NVR70 series rear panel is shown as below. See Figure 2-63.

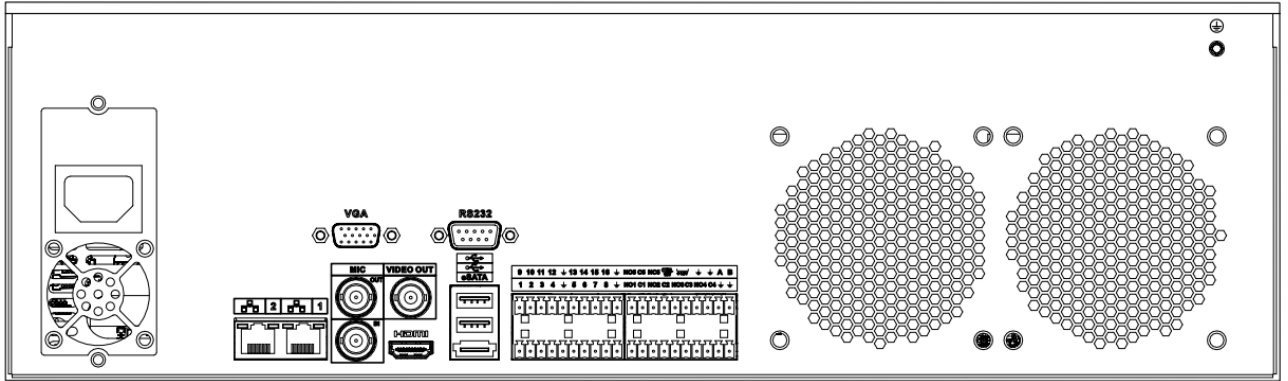



Figure 2-63

Please refer to the following sheet for detailed information.

Port Name		Function
Power switch	/	Power on-off button
Power input port	/	Input AC 100~240V.
MIC IN	Audio input port	Bidirectional talk input port. It is to receive the analog audio signal output from the devices such as microphone, pickup.
MIC OUT	Audio output port	Audio output port. It is to output the analog audio signal to the devices such as the sound box. <ul style="list-style-type: none"> ● Bidirectional talk output. ● Audio output on 1-window video monitor. ● Audio output on 1-window video playback.
VIDEO OUT	Video output port	CVBS output
1~16	Alarm input port 1~16	<ul style="list-style-type: none"> ● There are four groups. The first group is from port 1 to port 4, the second group is from port 5 to port 8, the third group is from 9 to 12, and the fourth group is from 13 to 16. They are to receive the signal from the external alarm source. There are two types; NO (normal open)/NC (normal close). ● When your alarm input device is using external power, please make sure the device and the NVR have the same ground.
	GND	Alarm input ground port.
NO1~NO5 C1~C5	Alarm output port 1~5	<ul style="list-style-type: none"> ● 5 groups of alarm output ports. (Group 1: port NO1~C1, Group 2: port NO2~C2, Group 3: port

Port Name		Function
NC5		<p>NO3~C3, Group 4: port NO4~C4, Group 5: port NO5, C5, NC5).Output alarm signal to the alarm device. Please make sure there is power to the external alarm device.</p> <ul style="list-style-type: none"> ● NO: Normal open alarm output port. ● C: Alarm output public end. ● NC: Normal close alarm output port.
A	RS-485 communication port	RS485_A port. It is the cable A. You can connect to the control devices such as speed dome PTZ.
B		RS485_B.It is the cable B. You can connect to the control devices such as speed dome PTZ.
CTRL 12V	/	Controller 12V power output. It is to control the on-off alarm relay output. It can be used to control the device alarm output. At the same time, it can also be used as the power input source of some devices such as the alarm detector.
+12V	/	+12V power output port. It can provide the power to some peripheral devices such as the camera or the alarm device. Please note the supplying power shall be below 1A.
	Network port	10M/100M/1000Mbps self-adaptive Ethernet port. Connect to the network cable.
eSATA	eSATA port	External SATA port. It can connect to the device of the SATA port. Please jump the HDD when there is peripheral connected HDD.
	USB2.0 port	USB2.0 port. Connect to mouse, USB storage device, USB burner and etc.
RS-232	RS232 debug COM.	It is for general COM debug to configure IP address or transfer transparent COM data.
HDMI	High Definition Media Interface	High definition audio and video signal output port. It transmits uncompressed high definition video and multiple-channel data to the HDMI port of the display device. HDMI version is 1.3
VGA	VGA video output port	VGA video output port. Output analog video signal. It can connect to the monitor to view analog video.

2.2.24 NVR70-R Series

The NVR70-R series rear panel is shown as below. See Figure 2-64.

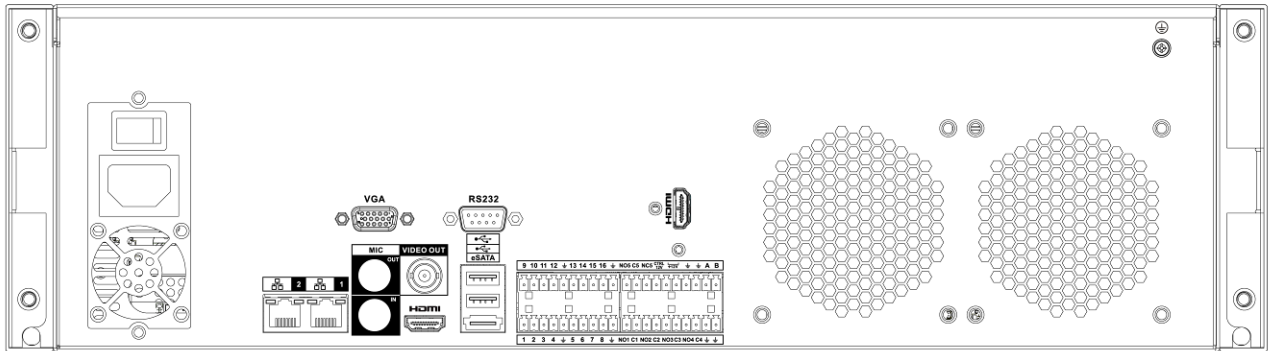



Figure 2-64

Please refer to the following sheet for detailed information.

Port Name		Function
Power switch	/	Power on-off button
Power input port	/	Input AC 100~240V.
MIC IN	Audio input port	Bidirectional talk input port. It is to receive the analog audio signal output from the devices such as microphone, pickup.
MIC OUT	Audio output port	Audio output port. It is to output the analog audio signal to the devices such as the sound box. <ul style="list-style-type: none"> ● Bidirectional talk output. ● Audio output on 1-window video monitor. ● Audio output on 1-window video playback.
VIDEO OUT	Video output port	CVBS output
1~16	Alarm input port 1~16	<ul style="list-style-type: none"> ● There are four groups. The first group is from port 1 to port 4, the second group is from port 5 to port 8, the third group is from 9 to 12, and the fourth group is from 13 to 16. They are to receive the signal from the external alarm source. There are two types; NO (normal open)/NC (normal close). ● When your alarm input device is using external power, please make sure the device and the NVR have the same ground.
	GND	Alarm input ground port.
NO1~NO5	Alarm output port 1~5	<ul style="list-style-type: none"> ● 5 groups of alarm output ports. (Group 1: port NO1~C1, Group 2: port NO2~C2, Group 3: port
C1~C5		

Port Name		Function
NC5		NO3~C3, Group 4: port NO4~C4, Group 5: port NO5, C5, NC5).Output alarm signal to the alarm device. Please make sure there is power to the external alarm device. <ul style="list-style-type: none"> ● NO: Normal open alarm output port. ● C: Alarm output public end. ● NC: Normal close alarm output port.
A	RS-485 communication port	RS485_A port. It is the cable A. You can connect to the control devices such as speed dome PTZ.
B		RS485_B.It is the cable B. You can connect to the control devices such as speed dome PTZ.
CTRL 12V	/	Controller 12V power output. It is to control the on-off alarm relay output. It can be used to control the device alarm output. At the same time, it can also be used as the power input source of some devices such as the alarm detector.
+12V	/	+12V power output port. It can provide the power to some peripheral devices such as the camera or the alarm device. Please note the supplying power shall be below 1A.
	Network port	10M/100M/1000Mbps self-adaptive Ethernet port. Connect to the network cable.
eSATA	eSATA port	External SATA port. It can connect to the device of the SATA port. Please jump the HDD when there is peripheral connected HDD.
	USB2.0 port	USB2.0 port. Connect to mouse, USB storage device, USB burner and etc.
RS-232	RS232 debug COM.	It is for general COM debug to configure IP address or transfer transparent COM data.
HDMI	High Definition Media Interface	High definition audio and video signal output port. It transmits uncompressed high definition video and multiple-channel data to the HDMI port of the display device. HDMI version is 1.3. The two HDMI ports to output video from different video sources.
VGA	VGA video output port	VGA video output port. Output analog video signal. It can connect to the monitor to view analog video.

2.2.25 NVR42V-8P Series

The interface is shown as in Figure 2-65.

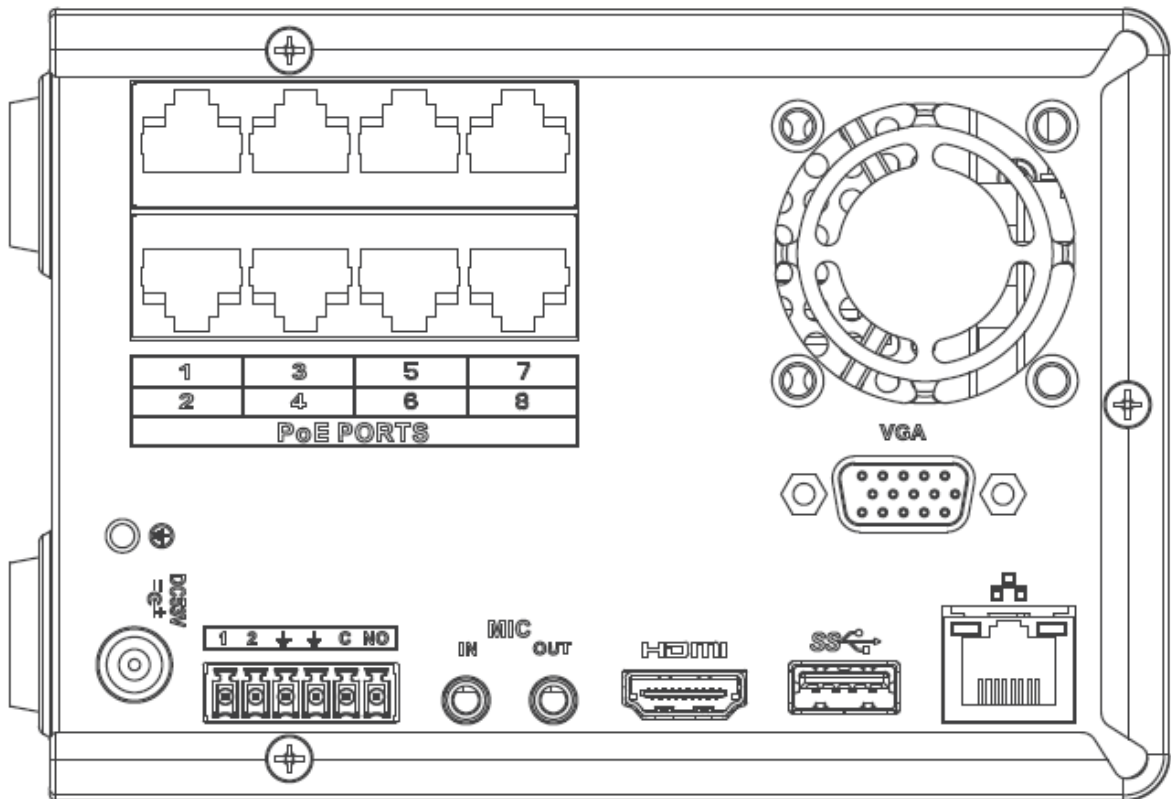



Figure 2-65

Please refer to the following sheet for detailed information.

Name		Function
Power switch	/	Power on/off button.
DC53V	Power input port	Input DC 53V--2.3A
MIC IN	Audio input port	Bidirectional talk input port. It is to receive the analog audio signal output from the devices such as microphone, pickup.
MIC OUT	Audio output port	Audio output port. It is to output the analog audio signal to the devices such as the sound box. <ul style="list-style-type: none"> ● Bidirectional talk output. ● Audio output on 1-window video monitor. ● Audio output on 1-window video playback.
1~2	Alarm input port 1~2	<ul style="list-style-type: none"> ● When your alarm input device is using external power, please make sure the device and the NVR have the same ground.
	GND	Alarm input ground port.
C	Alarm output public port	Alarm output public end.

Name		Function
NO	Normal open	Normal open alarm output port.
	Network port	10M/100M/1000Mbps self-adaptive Ethernet port. Connect to the network cable.
	USB3.0 port	USB3.0 port. Connect to mouse, USB storage device, USB burner and etc.
HDMI	High Definition Media Interface	High definition audio and video signal output port. It transmits uncompressed high definition video and multiple-channel data to the HDMI port of the display device. HDMI version is 1.4.
VGA	VGA video output port	VGA video output port. Output analog video signal. It can connect to the monitor to view analog video.
PoE PORT	/	Built-in Switch. Support PoE. The 8 PoE series product supports total 48V 120W. One PoE port max supports 15W.

2.2.26 NVR41-4KS2/41-P-4KS2/41-8P-4KS2

The NVR41-4KS2 series rear panel is shown as below. See Figure 2-66.

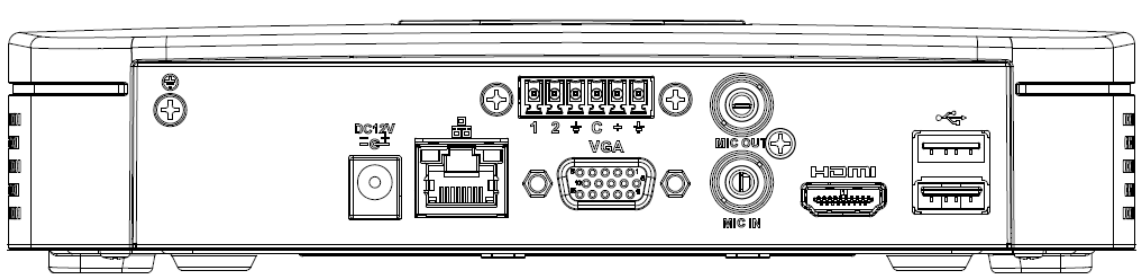

Figure 2-66

The NVR41-P-4KS2 series rear panel is shown as below. See Figure 2-67.

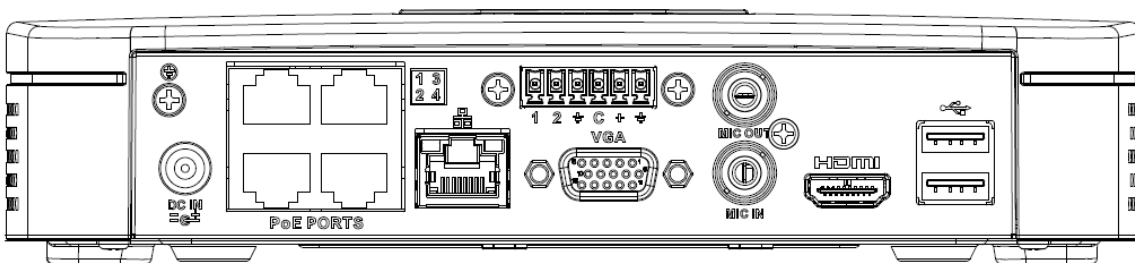

Figure 2-67

The NVR41-8P-4KS2 series rear panel is shown as below. See Figure 2-68.

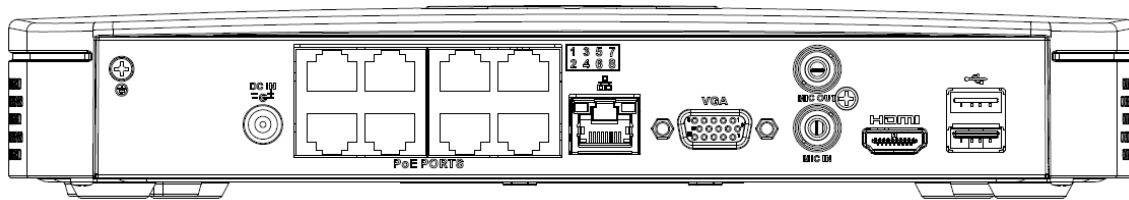



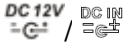

Figure 2-68

Please refer to the following sheet for detailed information.

Port Name	Connection	Function
	USB port	USB port. Connect to mouse, USB storage device, USB burner and etc.
	Network port	10M/100Mbps self-adaptive Ethernet port. Connect to the network cable.
HDMI	High Definition Media Interface	High definition audio and video signal output port. It transmits uncompressed high definition video and multiple-channel data to the HDMI port of the display device. HDMI version is 1.4.
VGA	VGA video output port	VGA video output port. Output analog video signal. It can connect to the monitor to view analog video.
	GND	Ground end
	Power input port	Power socket. For NVR41-4KS2: DC 12V/2A power. For NVR41-P-4KS2: DC 48V/72W power. For NVR41-8P-4KS2: DC 48V/96W power.
MIC IN	Audio input port	Bidirectional talk input port. It is to receive the analog audio signal output from the devices such as microphone, pickup.
MIC OUT	Audio output port	Audio output port. It is to output the analog audio signal to the devices such as the sound box. <ul style="list-style-type: none"> ● Bidirectional talk output. ● Audio output on 1-window video monitor. ● Audio output on 1-window video playback.
PoE PORT	PoE port	Built-in switch. Support PoE function. For PoE series product, you can use this port to provide power to the network camera.

2.2.27 NVR41HS-4KS2/41HS-P-4KS2/41HS-8P-4KS2

The NVR41HS-4KS2 series rear panel is shown as below. See Figure 2-69.

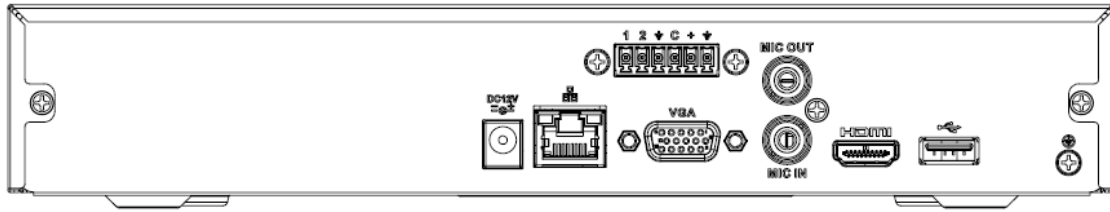

Figure 2-69

The NVR41HS-P-4KS2 series rear panel is shown as below. See Figure 2-70.

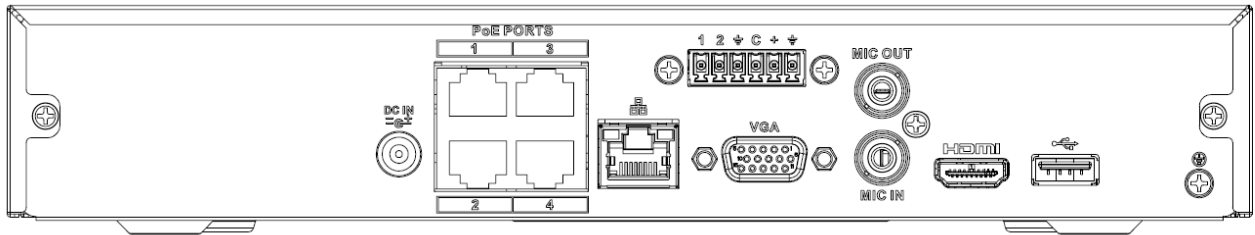

Figure 2-70

The NVR41HS-8P-4KS2 series rear panel is shown as below. See Figure 2-71

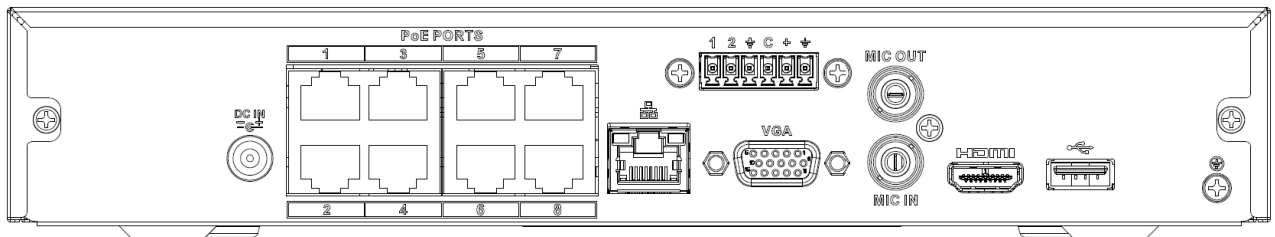

Figure 2-71

Please refer to the following sheet for detailed information.

Port Name	Connection	Function
	USB port	USB port. Connect to mouse, USB storage device, USB burner and etc.
	Power input port	Power socket. For NVR41HS-4KS2: DC 12V/2A power. For NVR41HS-P-4KS2: DC 48V/72W power. For NVR41HS-8P-4KS2: DC 48V/96W power.
	Network port	10M/100Mbps self-adaptive Ethernet port. Connect to the network cable.
	USB port	USB port. Connect to mouse, USB storage device and etc.
HDMI	High Definition Media Interface	High definition audio and video signal output port. It transmits uncompressed high definition video and multiple-channel data to the HDMI port of the display device. HDMI version is 1.4.

Port Name	Connection	Function
VGA	VGA video output port	VGA video output port. Output analog video signal. It can connect to the monitor to view analog video.
MIC IN	Audio input port	Bidirectional talk input port. It is to receive the analog audio signal output from the devices such as microphone, pickup.
MIC OUT	Audio output port	Audio output port. It is to output the analog audio signal to the devices such as the sound box. <ul style="list-style-type: none"> ● Bidirectional talk output. ● Audio output on 1-window video monitor. ● Audio output on 1-window video playback.
⏏	GND	Ground end
PoE PORTS	PoE port	Built-in switch. Support PoE function. For PoE series product, you can use this port to provide power to the network camera.

2.2.28 NVR42-4KS2/42-P-4KS2/42-8P-4KS2/42-16P-4KS2

The NVR42-4KS2 series rear panel is shown as below. See Figure 2-72.

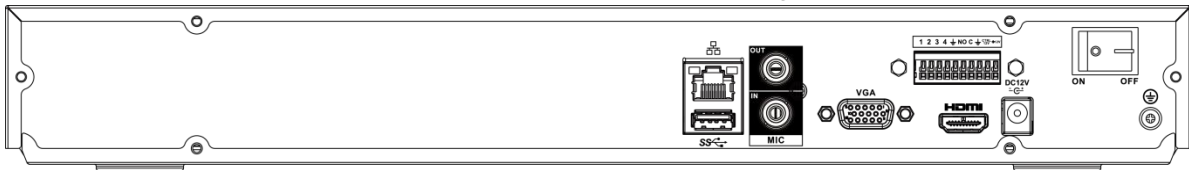

Figure 2-72

The NVR42-P-4KS2 series rear panel is shown as below. See Figure 2-73.

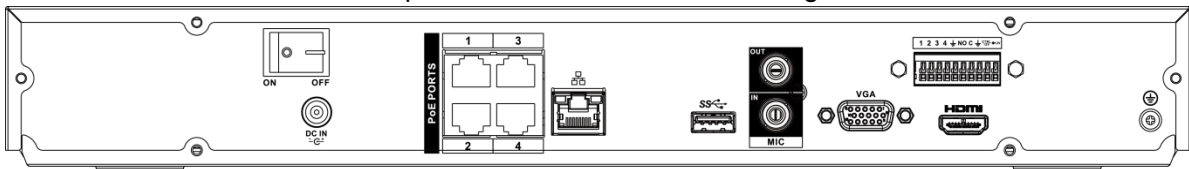

Figure 2-73

The NVR42-8P-4KS2 series rear panel is shown as below. See Figure 2-74.

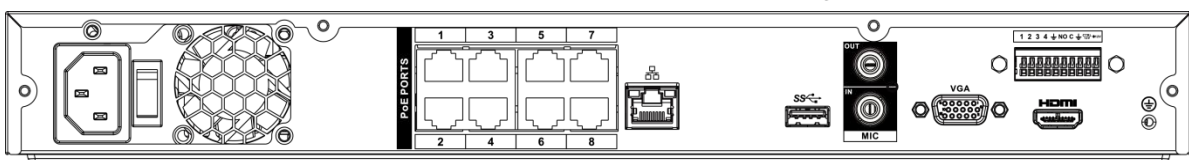

Figure 2-74

The NVR42-16P-4KS2 series rear panel is shown as below. See Figure 2-75.

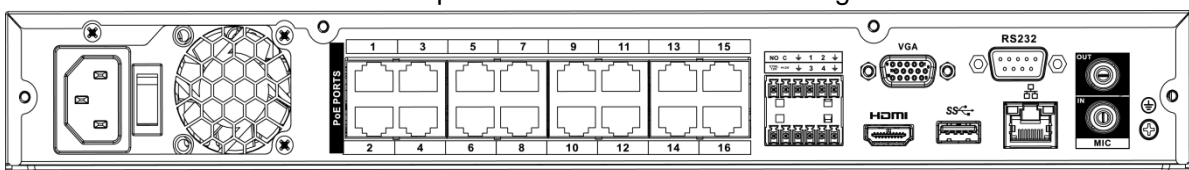
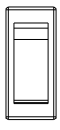







Figure 2-75

Please refer to the following sheet for detailed information.

Name		Function
	Power switch	Power on/off button.
		
	Power input port	Input DC 12V/4A. For NVR42-4KS2 series product only.
		Switch power port. Input DC 48/96W For NVR42-P-4KS2 series product only.
		Input AC90V~264V-12V5A/52V2.5A-190W. For NVR42-8P-4KS2/NVR42-16P-4KS2 series product only.
MIC IN	Audio input port	Bidirectional talk input port. It is to receive the analog audio signal output from the devices such as microphone, pickup.
MIC OUT	Audio output port	Audio output port. It is to output the analog audio signal to the devices such as the sound box. <ul style="list-style-type: none"> ● Bidirectional talk output. ● Audio output on 1-window video monitor. ● Audio output on 1-window video playback.
1~4	Alarm input port 1~4	<ul style="list-style-type: none"> ● There are two types; NO (normal open)/NC (normal close). ● When your alarm input device is using external power, please make sure the device and the NVR have the same ground.
	GND	Alarm input ground port.
N1, N2	Alarm output port 1~2	<ul style="list-style-type: none"> ● 2 groups of alarm output ports. (Group 1: port NO1~C1, Group 2: port NO2~C2). Output alarm signal to the alarm device. Please make sure there is power to the external alarm device. ● NO: Normal open alarm output port. ● C: Alarm output public end.
C1, C2		
A	RS-485 communication port	RS485_A port. It is the cable A. You can connect to the control devices such as speed dome PTZ.
B		RS485_B. It is the cable B. You can connect to the control devices such as speed dome PTZ.
	Network port	10M/100M/1000Mbps self-adaptive Ethernet port. Connect to the network cable.

Name		Function
	USB port	USB port. Connect to mouse, USB storage device, USB burner and etc.
RS-232	RS-232 debug COM.	It is for general COM debug to configure IP address or transfer transparent COM data.
HDMI	High Definition Media Interface	High definition audio and video signal output port. It transmits uncompressed high definition video and multiple-channel data to the HDMI port of the display device. HDMI version is 1.4.
VGA	VGA video output port	VGA video output port. Output analog video signal. It can connect to the monitor to view analog video.
PoE PORTS	/	Built-in Switch. Support PoE. For PoE series product, you can use this port to provide power to the network camera.

2.2.29 NVR44-4KS2/44-16P-4KS2

The NVR44-4KS2 series rear panel is shown as below. See Figure 2-76.

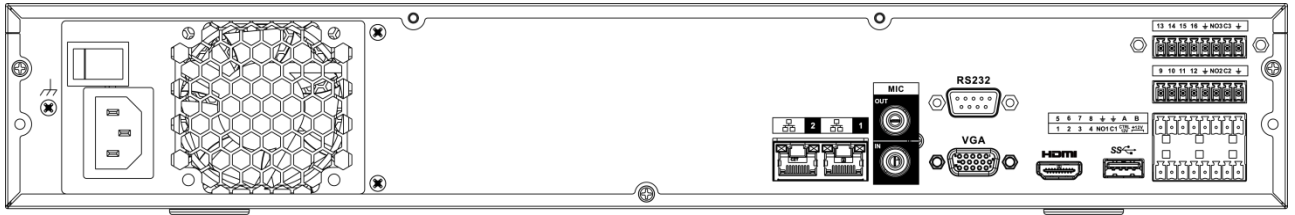

Figure 2-76

The NVR44-16P-4KS2 series rear panel is shown as below. See Figure 2-77.

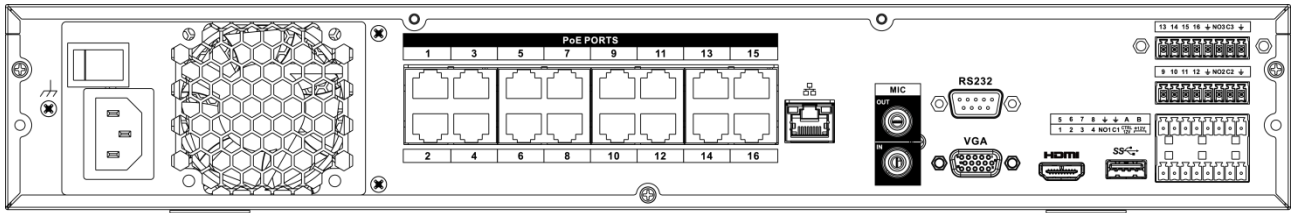





Figure 2-77

Please refer to the following sheet for detailed information.

Name		Function
Power switch	/	Power on-off button
Power input port	/	AC90V~264V-12V12.5A/-53V2.83A

Name		Function
MIC IN	Audio input port	Bidirectional talk input port. It is to receive the analog audio signal output from the devices such as microphone, pickup.
MIC OUT	Audio output port	Audio output port. It is to output the analog audio signal to the devices such as the sound box. <ul style="list-style-type: none"> ● Bidirectional talk output. ● Audio output on 1-window video monitor. ● Audio output on 1-window video playback.
VIDEO OUT	Video output port	CVBS output
1~16	Alarm input port 1~16	<ul style="list-style-type: none"> ● There are four groups. The first group is from port 1 to port 4, the second group is from port 5 to port 8, the third group is from 9 to 12, and the fourth group is from 13 to 16. They are to receive the signal from the external alarm source. There are two types; NO (normal open)/NC (normal close). ● When your alarm input device is using external power, please make sure the device and the NVR have the same ground.
	Video output port	CVBS output
NO1~NO5	Alarm output port 1~5	<ul style="list-style-type: none"> ● 5 groups of alarm output ports. (Group 1: port NO1~C1, Group 2: port NO2~C2, Group 3: port NO3~C3, Group 4: port NO4~C4, Group 5: port NO5, C5, NC5). Output alarm signal to the alarm device. Please make sure there is power to the external alarm device. ● NO: Normal open alarm output port. ● C: Alarm output public end. ● NC: Normal close alarm output port.
C1~C5		
NC5		
A	RS-485 communication port	RS485_A port. It is the cable A. You can connect to the control devices such as speed dome PTZ.
B		RS485_B. It is the cable B. You can connect to the control devices such as speed dome PTZ.
CTRL 12V	/	Controller 12V power output. It is to control the on-off alarm relay output. It can be used to control the device alarm output. At the same time, it can also be used as the power input source of some devices such as the alarm detector.
+12V	/	+12V power output port. It can provide the power to some peripheral devices such as the camera or the alarm device. Please note the supplying power shall be below 1A.
	Network port	10M/100M/1000Mbps self-adaptive Ethernet port. Connect to the network cable.

Name		Function
eSATA	eSATA port	External SATA port. It can connect to the device of the SATA port. Please jump the HDD when there is peripheral connected HDD.
	USB2.0 port	USB2.0 port. Connect to mouse, USB storage device, USB burner and etc.
RS-232	RS232 debug COM.	It is for general COM debug to configure IP address or transfer transparent COM data.
HDMI	High Definition Media Interface	High definition audio and video signal output port. It transmits uncompressed high definition video and multiple-channel data to the HDMI port of the display device. HDMI version is 1.3
VGA	VGA video output port	VGA video output port. Output analog video signal. It can connect to the monitor to view analog video.
PoE PORTS	PoE port	Built-in Switch. Support PoE. For PoE series product, you can use this port to provide power to the network camera.

2.2.30 NVR48-4KS2/48-16P-4KS2

The NVR48-4KS2 series rear panel is shown as below. See Figure 2-78.

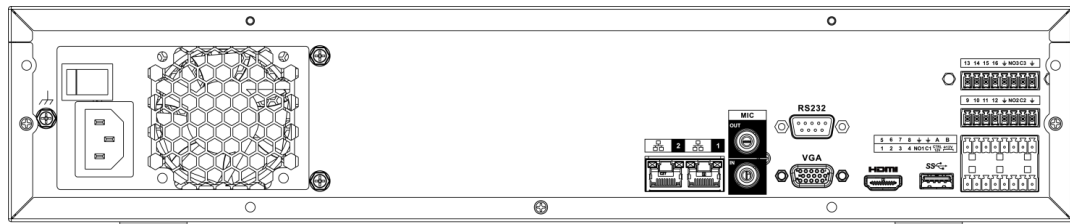

Figure 2-78

The NVR48-16P-4KS2 series rear panel is shown as below. See Figure 2-79.

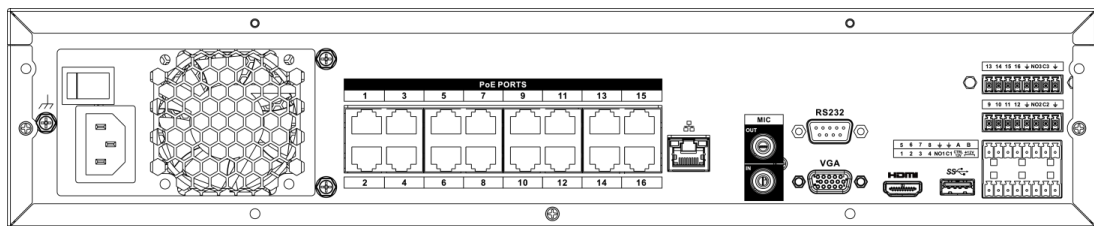





Figure 2-79

Please refer to the following sheet for detailed information.

Name		Function
Power switch	/	Power on-off button
Power input port	/	AC90V~264V-12V12.5A/-53V2.83A

Name		Function
MIC IN	Audio input port	Bidirectional talk input port. It is to receive the analog audio signal output from the devices such as microphone, pickup.
MIC OUT	Audio output port	Audio output port. It is to output the analog audio signal to the devices such as the sound box. <ul style="list-style-type: none"> ● Bidirectional talk output. ● Audio output on 1-window video monitor. ● Audio output on 1-window video playback.
VIDEO OUT	Video output port	CVBS output.
1~16	Alarm input port 1~16	<ul style="list-style-type: none"> ● There are four groups. The first group is from port 1 to port 4, the second group is from port 5 to port 8, the third group is from 9 to 12, and the fourth group is from 13 to 16. They are to receive the signal from the external alarm source. There are two types; NO (normal open)/NC (normal close). ● When your alarm input device is using external power, please make sure the device and the NVR have the same ground.
	GND	Alarm input ground port.
NO1~NO5 C1~C5 NC5	Alarm output port 1~5	<ul style="list-style-type: none"> ● 5 groups of alarm output ports. (Group 1: port NO1~C1, Group 2: port NO2~C2, Group 3: port NO3~C3, Group 4: port NO4~C4, Group 5: port NO5, C5, NC5). Output alarm signal to the alarm device. Please make sure there is power to the external alarm device. ● NO: Normal open alarm output port. ● C: Alarm output public end. ● NC: Normal close alarm output port.
A	RS-485 communication port	RS485_A port. It is the cable A. You can connect to the control devices such as speed dome PTZ.
B		RS485_B. It is the cable B. You can connect to the control devices such as speed dome PTZ.
CTRL 12V	/	Controller 12V power output. It is to control the on-off alarm relay output. It can be used to control the device alarm output. At the same time, it can also be used as the power input source of some devices such as the alarm detector.
+12V	/	+12V power output port. It can provide the power to some peripheral devices such as the camera or the alarm device. Please note the supplying power shall be below 1A.
	Network port	One 10M/100M/1000Mbps self-adaptive Ethernet port. Connect to the network cable.

Name		Function
eSATA	eSATA port	External SATA port. It can connect to the device of the SATA port. Please jump the HDD when there is peripheral connected HDD.
	USB port	USB port. Connect to mouse, USB storage device, USB burner and etc.
RS-232	RS-232 debug COM.	It is for general COM debug to configure IP address or transfer transparent COM data.
HDMI	High Definition Media Interface	High definition audio and video signal output port. It transmits uncompressed high definition video and multiple-channel data to the HDMI port of the display device. HDMI version is 1.4.
VGA	VGA video output port	VGA video output port. Output analog video signal. It can connect to the monitor to view analog video.
PoE PORTS	PoE port	Built-in Switch. Support PoE. For PoE series product, you can use this port to provide power to the network camera.

2.3 Alarm Connection

2.3.1 Alarm Port

The alarm port is shown as below. See Figure 2-80. The following figure is based on the 78 series.

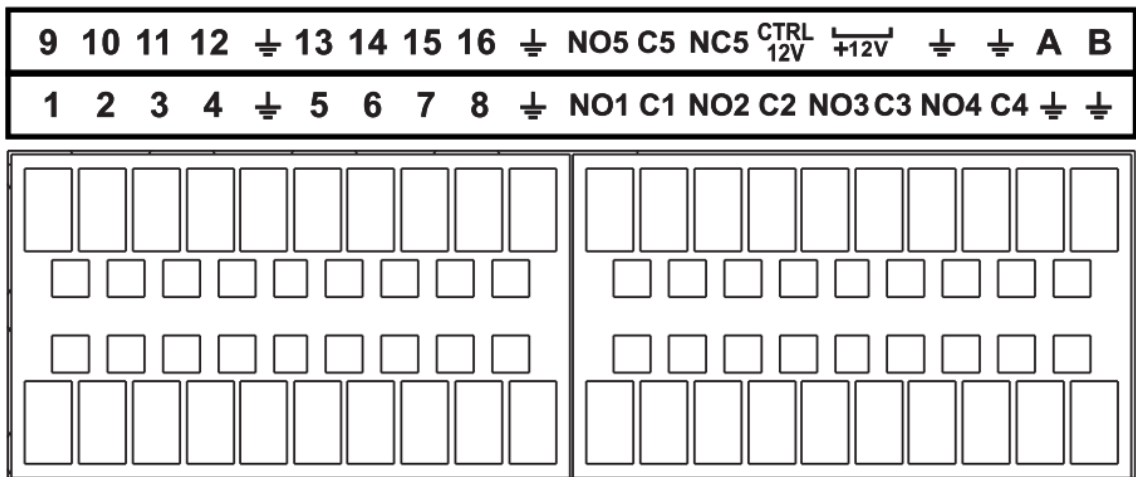

Figure 2-80

Icon	Function
1~16	ALARM1~ALARM16. The alarm becomes activated in the low level.
NO1 C1, NO2 C2, NO3 C3, NO4 C4	Four NO activation output groups. (On-off button).
NO5 C5 NC5	One NO/NC activation output group. (On-off button).
CTRL 12V	Control power output. Disable power output when alarm is

	canceled. Current is 500mA.
+12V	Rated current output. Current is 500mA.
	GND
A/B	485 communication port. They are used to control devices such as PTZ. Please parallel connect 120TΩ between A/B cables if there are too many PTZ decoders.

Note

- Different models support different alarm input ports. Please refer to the specifications sheet for detailed information.
- Slight difference may be found on the alarm port layout.

2.3.2 Alarm input port

Connect the positive end (+) of the alarm input device to the alarm input port (ALARM IN 1~16) of the NVR. Connect the negative end (-) of the alarm input device to the ground end () of the NVR.

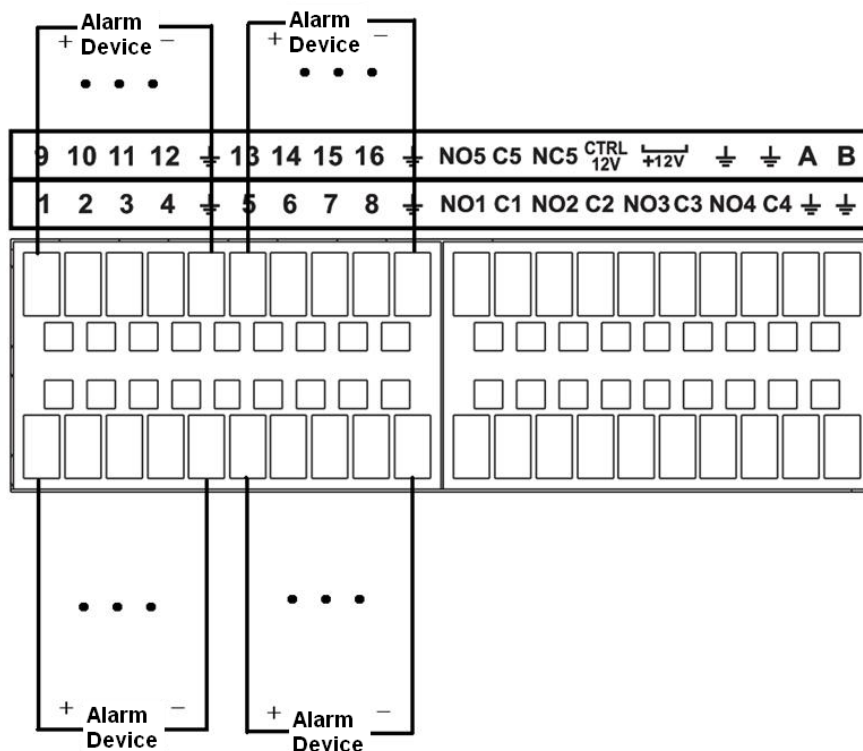

Figure 2-81

Note

- There are two alarm input types: NO/NC.
- When connect the ground port of the alarm device to the NVR, you can use any of the GND ports () .
- Connect the NC port of the alarm device to the alarm input port (ALARM) of the NVR.
- When there is peripheral power supplying for the alarm device, please make sure it is earthed with the NVR.

2.3.3 Alarm input and output port

- There is peripheral power supplying for the external alarm device.

- In case overload may result in NVR damage, please refer to the following relay specifications for detailed information.
- A/B cable of the RS485 is for the A/B cable connection of the speed PTZ.

2.3.4 Alarm relay specifications

Model:	JRC-27F	
Material of the touch	Silver	
Rating (Resistance Load)	Rated switch capacity	30VDC 2A, 125VAC 1A
	Maximum switch power	125VA 160W
	Maximum switch voltage	250VAC, 220VDC
	Maximum switch current	1A
Insulation	Between touches with same polarity	1000VAC 1minute
	Between touches with different polarity	1000VAC 1minute
	Between touch and winding	1000VAC 1minute
Surge voltage	Between touches with same polarity	1500V (10×160us)
Length of open time	3ms max	
Length of close time	3ms max	
Longevity	Mechanical	50×10 ⁶ MIN (3Hz)
	Electrical	200×10 ³ MIN (0.5Hz)
Temperature	-40℃ ~+70℃	

2.4 Bidirectional talk

2.4.1 Device-end to PC-end

Device Connection

Please connect the speaker or the pickup to the first audio input port in the device rear panel. Then connect the earphone or the sound box to the audio output port in the PC.

Login the Web and then enable the corresponding channel real-time monitor.

Please refer to the following interface to enable bidirectional talk. See Figure 2-82.

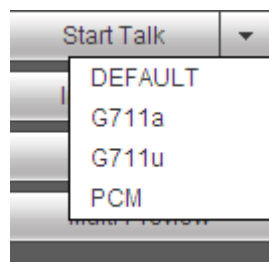

Figure 2-82

Listening Operation

At the device end, speak via the speaker or the pickup, and then you can get the audio from the earphone

or sound box at the pc-end. See Figure 2-83.

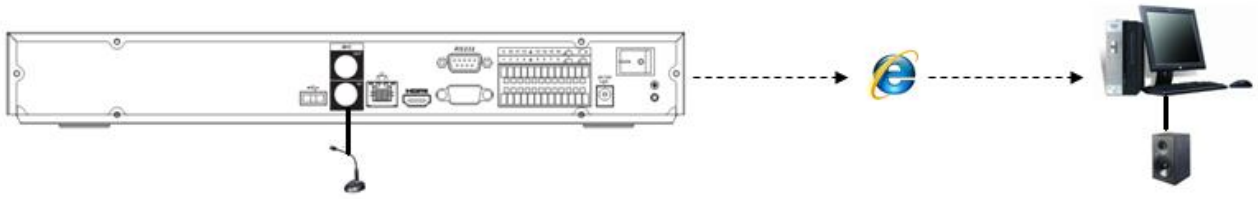

Figure 2-83

2.4.2 PC-end to the device-end

Device Connection

Connect the speaker or the pickup to the audio output port in the PC and then connect the earphone or the sound box to the first audio input port in the device rear panel.

Login the Web and then enable the corresponding channel real-time monitor.

Please refer to the above interface (Figure 2-82) to enable bidirectional talk.

Listening Operation

At the PC-end, speak via the speaker or the pickup, and then you can get the audio from the earphone or sound box at the device-end. See Figure 2-84.

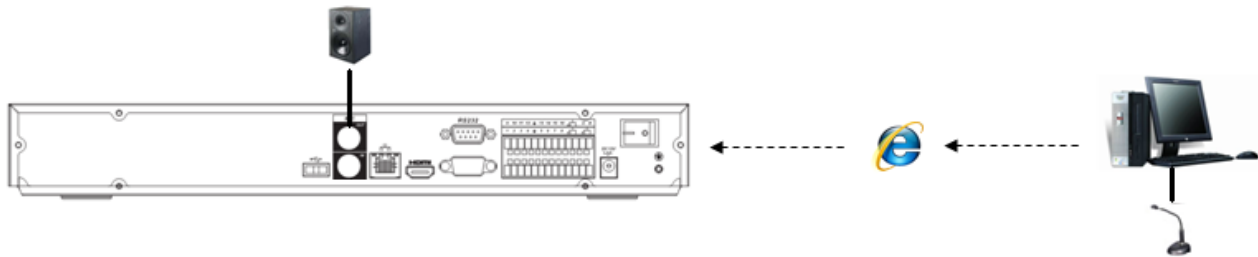
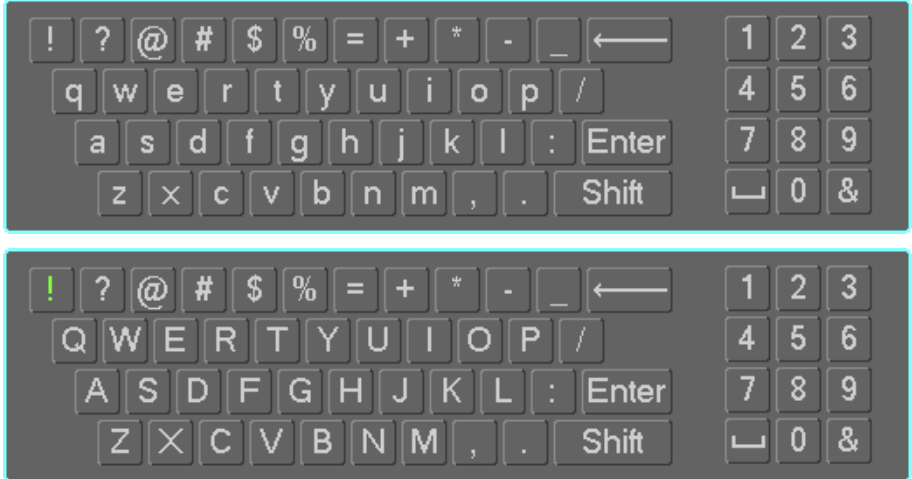

Figure 2-84

2.5 Mouse Operation

Please refer to the following sheet for mouse operation instruction.

Left mouse	click	When you have selected one menu item, left click mouse to view menu content.
		Modify checkbox or motion detection status.
		Click combo box to pop up dropdown list

	<p>In input box, you can select input methods. Left click the corresponding button on the panel you can input numeral/English character (small/capitalized). Here ← stands for backspace button. _ stands for space button.</p> <p>In English input mode: _stands for input a backspace icon and ← stands for deleting the previous character.</p>  <p>In numeral input mode: _ stands for clear and ← stands for deleting the previous numeral.</p>
Double left click mouse	<p>Implement special control operation such as double click one item in the file list to playback the video.</p> <p>In multiple-window mode, double left click one channel to view in full-window. Double left click current video again to go back to previous multiple-window mode.</p>
Right click mouse	<p>In real-time monitor mode, pops up shortcut menu.</p> <p>Exit current menu without saving the modification.</p>
Press middle button	<p>In numeral input box: Increase or decrease numeral value.</p> <p>Switch the items in the check box.</p> <p>Page up or page down</p>
Move mouse	Select current control or move control
Drag mouse	<p>Select motion detection zone</p> <p>Select privacy mask zone.</p>

2.6 Remote Control

The remote control interface is shown as in Figure 2-85.

Please note remote control is not our standard accessory and it is not included in the accessory bag.

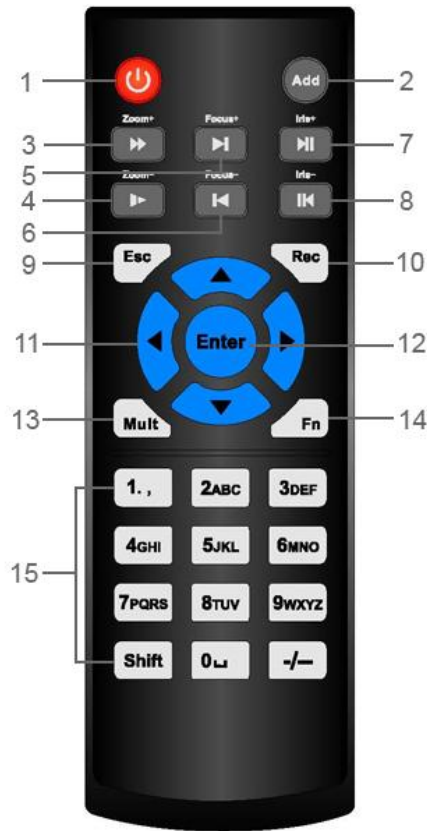

Figure 2-85

Serial Number	Name	Function
1	Power button	Click it to boot up or shut down the device.
2	Address	Click it to input device number, so that you can control it.
3	Forward	Various forward speeds and normal speed playback.
4	Slow play	Multiple slow play speeds or normal playback.
5	Next record	In playback mode, playback the next video.
6	Previous record	In playback mode, playback the previous video.
7	Play/Pause	In pause mode, click this button to realize normal playback. In normal playback click this button to pause playback. In real-time monitor mode, click this button to enter video search menu.
8	Reverse/pause	Reverse playback pause mode, click this button to realize normal playback.

		In reverse playback click this button to pause playback.
9	Esc.	Go back to previous menu or cancel current operation (close upper interface or control)
10	Record	Start or stop record manually In record interface, working with the direction buttons to select the record channel. Click this button for at least 1.5 seconds, system can go to the Manual Record interface.
11	Direction keys	Switch current activated control, go to left or right. In playback mode, it is to control the playback process bar. Aux function(such as switch the PTZ menu)
12	Enter /menu key	go to default button go to the menu
13	Multiple-window switch	Switch between multiple-window and one-window.
14	Fn	In 1-ch monitor mode: pop up assistant function: PTZ control and Video color.
		Switch the PTZ control menu in PTZ control interface.
		In motion detection interface, working with direction keys to complete setup.
		In text mode, click it to delete character.
15	0-9 number key	Input password, channel or switch channel.
		Shift is the button to switch the input method.

3 Device Installation

Note: All the installation and operations here should conform to your local electric safety rules.

3.1 Check Unpacked NVR

When you receive the NVR from the forwarding agent, please check whether there is any visible damage. The protective materials used for the package of the NVR can protect most accidental clashes during transportation. Then you can open the box to check the accessories.

Please check the items in accordance with the list. Finally you can remove the protective film of the NVR.

3.2 About Front Panel and Rear Panel

The model number in the stick on the bottom of NVR is very important; please check according to your purchase order.

The label in the rear panel is very important too. Usually we need you to represent the serial number when we provide the service after sales.

3.3 HDD Installation

Important:

Please turn off the power before you replace the HDD.

The pictures listed below for reference only.

For the first time install, please be aware that whether the HDDs have been installed.

You can refer to the Appendix for HDD space information and recommended HDD brand. Please use HDD of 7200rpm or higher. **Usually we do not recommend the PC HDD.**

Please follow the instructions below to install hard disk.

3.3.1 NVR100/100-P Series



Please make sure the metal surface of the HDD is facing up when you are installing!

This series NVR has only one 2.5-inch SATA HDD.

Please follow the instructions below to install HDD.



① Draw out the HDD bracket



② Make sure the HDD metal surface is facing up and then put the HDD into the bracket



③ Put the HDD into the device

horizontally. After the HDD is in the proper position, the columns on the two sides can lock the screw holes of the HDD to secure it.

When you remove the HDD, please refer to the following figure to pull the spring up and then remove the HDD.

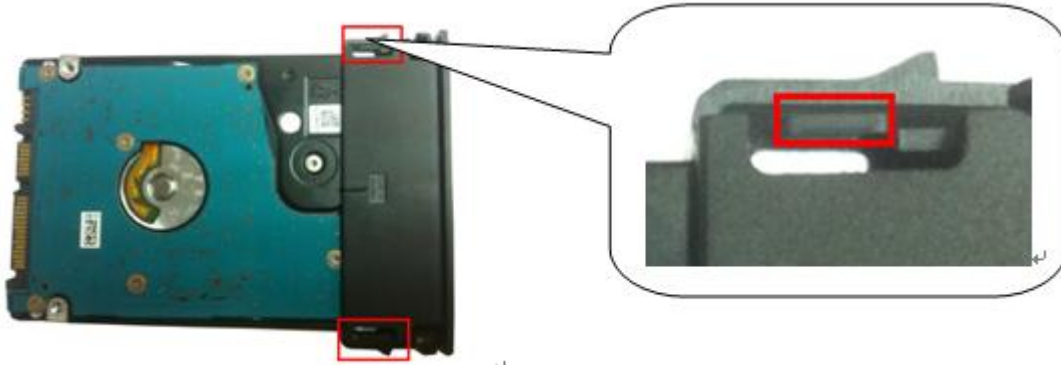

3.3.2 NVR11/11-P/41/41-P/41-8P/41-W/21-S2/21-P-S2/21-8P-S2/41-4KS2/41-P-4KS2/41-8P-4KS2 Series



①. Loosen the screws of the upper cover and side panel.



② Fix four screws in the HDD (Turn just three rounds).



③ Place the HDD in accordance with the four holes in the bottom.



④ Turn the device upside down and then turn the screws in firmly.



⑤ Fix the HDD firmly.



⑥ Connect the HDD cable and power cable.



- ⑦ Put the cover in accordance with the clip and then place the upper cover back.
- ⑧ Secure the screws in the rear panel and the side panel.

3.3.3 NVR11H/11H-P/41H/41H-P/41H-8P/11HS/21HS-S2/21HS-P-S2/21HS-8P-S2/41HS-W-S2/41HS-4KS2/ 41HS-P-4KS2/41HS-8P-4KS2 Series



- ①. Loosen the screws of the upper cover and side panel.
- ② Fix four screws in the HDD (Turn just three rounds).
- ③ Place the HDD in accordance with the four holes in the bottom.



- ④ Turn the device upside down and then turn the screws in firmly.
- ⑤ Fix the HDD firmly.
- ⑥ Connect the HDD cable and power cable.



- ⑦ Put the cover in accordance with the clip and then place the upper cover back.
- ⑧ Secure the screws in the rear panel and the side panel.

3.3.4 NVR42/42N/42-P/42-8P/42-16P/72/72-8P/42-4K/42-8P-4K/52-4KS2/52-8P-4KS2/52-16P-4KS2/22-S2/22-P-S2/22-8P-S2/42-4KS2/42-P-4KS2/42-8P-4KS2/42-16P-4KS2 Series

The following figures are based on the NVR 72-8P series.



① Loosen the screws of the upper cover and side panel.

② Fix four screws in the HDD (Turn just three rounds).

③ Place the HDD in accordance with the four holes in the bottom.



④ Turn the device upside down and then turn the screws in firmly.

⑤ Fix the HDD firmly.

⑥ Connect the HDD cable and power cable.



⑦ Put the cover in accordance with the clip and then place the upper cover back.

⑧ Secure the screws in the rear panel and the side panel.

3.3.5 NVR44/44-8P/44-16P/74/74-8P/74-16P/44-4K/54-4KS2/54-16P-4KS2/44-4KS2/44-16P-4KS2 Series



① Use the screwdriver to loose the screws of the rear panel and then remove the front cover.



② Put the HDD to the HDD bracket in the chassis and then line up the four screws to the four holes in the HDD. Use the screwdriver to fix the screws firmly to secure HDD on the HDD bracket



③ Connect to the HDD data cable to the main board and the HDD port respectively. Loosen the power cable of the chassis and connect another end of the power cable to the HDD port.



④ After connect the cable, put the front cover back to the device and then fix screws of the rear panel.

3.3.6 NVR48/48-16P/NVR78/78-16P/48-4K/58-4KS2/58-16P-4KS2/48-4KS2/48-16P-4KS 2 Series

The following figures are based on the NVR78 series.



① Use the screwdriver to loose the screws of the rear panel and then remove the front cover.



② Put the HDD to the HDD bracket in the chassis and then line up the four screws to the four holes in the HDD. Use the screwdriver to fix the screws firmly to secure HDD on the HDD bracket



③ Connect to the HDD data cable to the main board and the HDD port respectively. Loosen the power cable of the chassis and connect another end of the power cable to the HDD port.

④ After connect the cable, put the front cover back to the device and then fix screws of the rear panel.

3.3.7 NVR78-RH Series



① Turn the key into the hole in the front panel.

② Open the front panel.



③ Put the HDD to the slot and adjust the handle to secure it.

④ Put the front panel back and use the key to fix firmly.

HDD Handle Installation



①Line up the handle to the HDD side (without the interface)

②Use the screwdriver to fix the handle on the HDD.

3.3.8 NVR70/70-R Series



①Use four screws to secure the HDD.



②Put the HDD to the HDD box at the front panel of the device. .



③Please pull the handle up when you are inputing the HDD box in case the the handle



④Put the HDD to the HDD box at the front panel of the device. .

collides with the front panel

3.3.9 NVR42V-8P Series

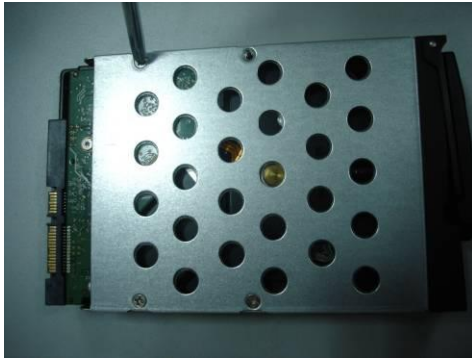

① Use 4 screws to secure the HDD



② Put the HDD to the HDD box at the front.



③ Pull the HDD knob up when you put the HDD into the box in case the knob buckle may strike the front panel.



④ Put the knob back after you insert the HDD to the SATA board.

3.4 CD-ROM Installation

Please follow the steps listed below.



① Open top cover and then remove the HDD bracket



② Take off the bottom of the HDD bracket and CD-ROM bracket.



③ Fix the CD-ROM bracket at the HDD bracket.



④ Install a pair of the CD-ROM bracket. Please make sure the reverse side is secure too.



⑤ Install SATA burner. Line up the SATA burner to the hole positions.



⑥ User screwdriver to fix the screws.



⑦ Put the bracket back. Please adjust the CD-ROM to the proper position so that the button of the front panel is directly facing the pop-up button of the CD-ROM.

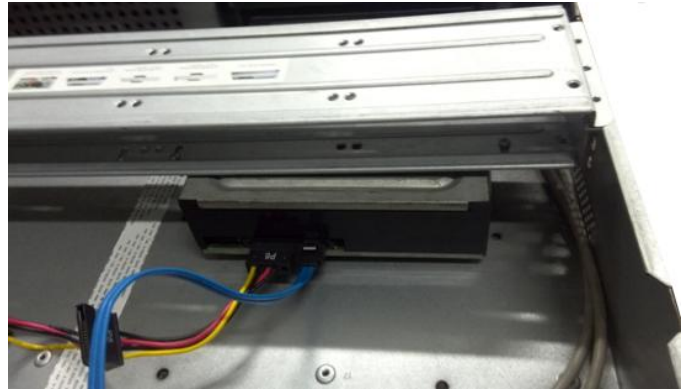

⑧ Connect the SATA cable and power wire.



- ⑨ Secure the HDD bracket and put the top cover back.

3.5 Connection Sample

3.5.1 NVR100/NVR100-P Series

Please refer to Figure 3-1 for connection sample.
Here we take NVR100-P as an example.

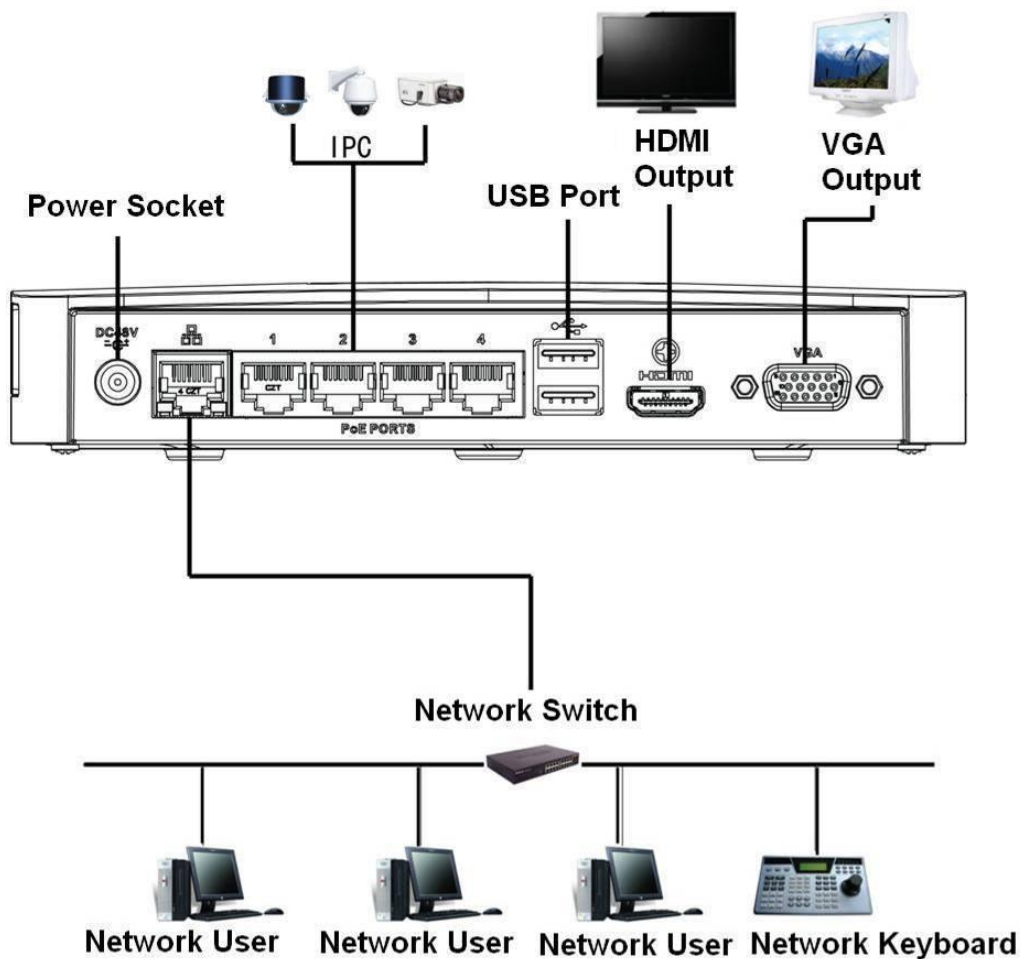

Figure 3-1

3.5.2 NVR11/11-P/41/41-P/41-8P/41-W/21-S2/21-P-S2/21-8P-S2//41-4KS2/41-P-4KS2/41-8P-4KS2 Series

Please refer to Figure 3-2 for connection sample.
Here we take NVR41 as an example.

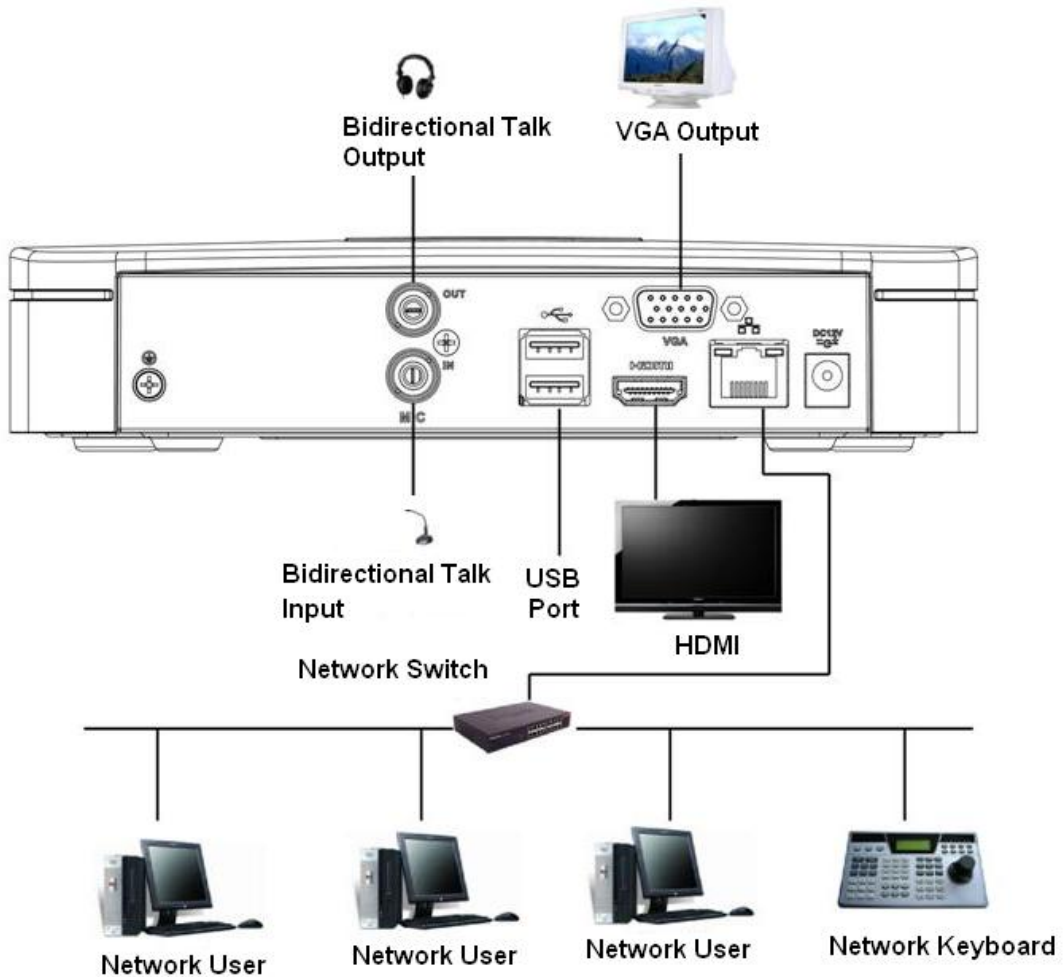

Figure 3-2

3.5.3 NVR11H/11H-P/41H/41H-P/41H-8P Series

Please refer to Figure 3-3 for connection sample.
Here we take NVR41H as an example.

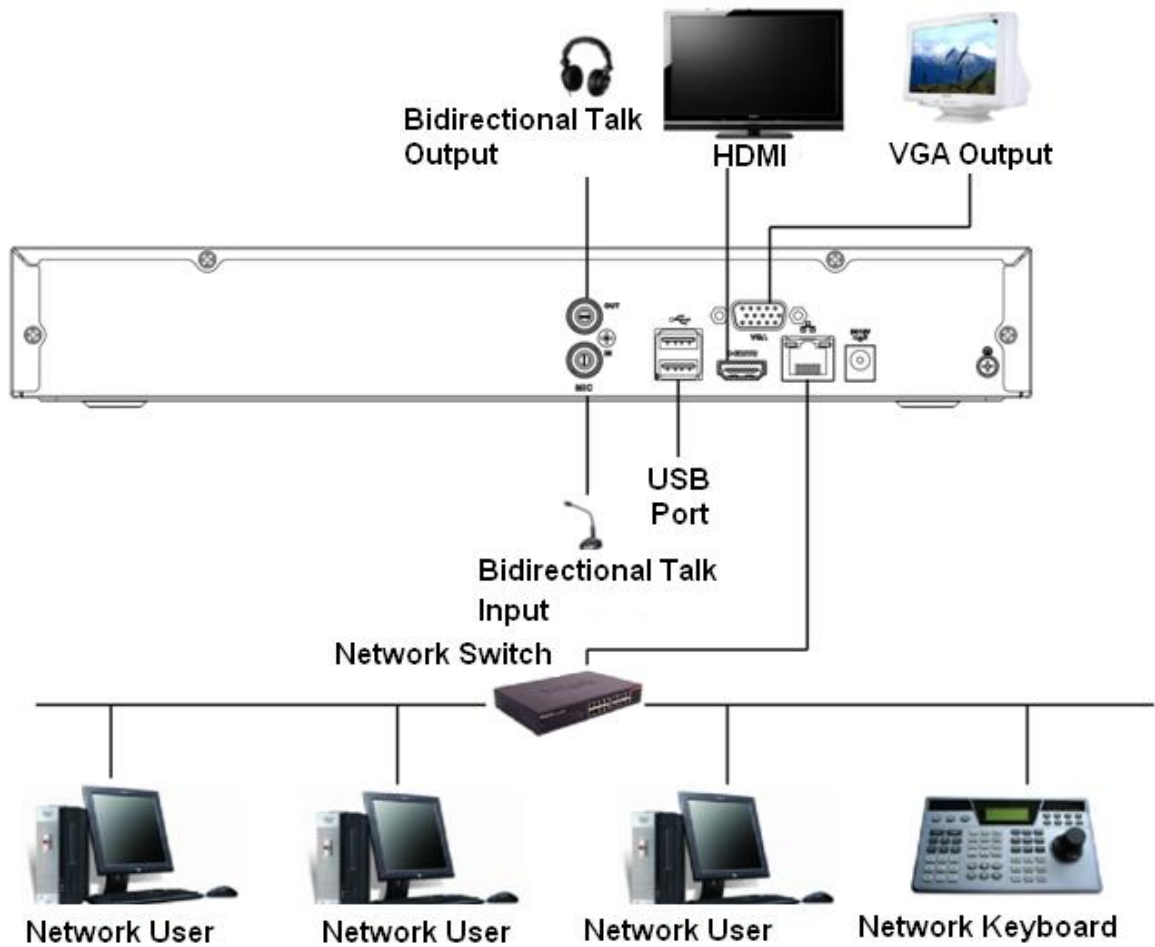

Figure 3-3

3.5.4 NVR11HS//41HS-W-S2 Series

Please refer to Figure 3-4 for connection sample.

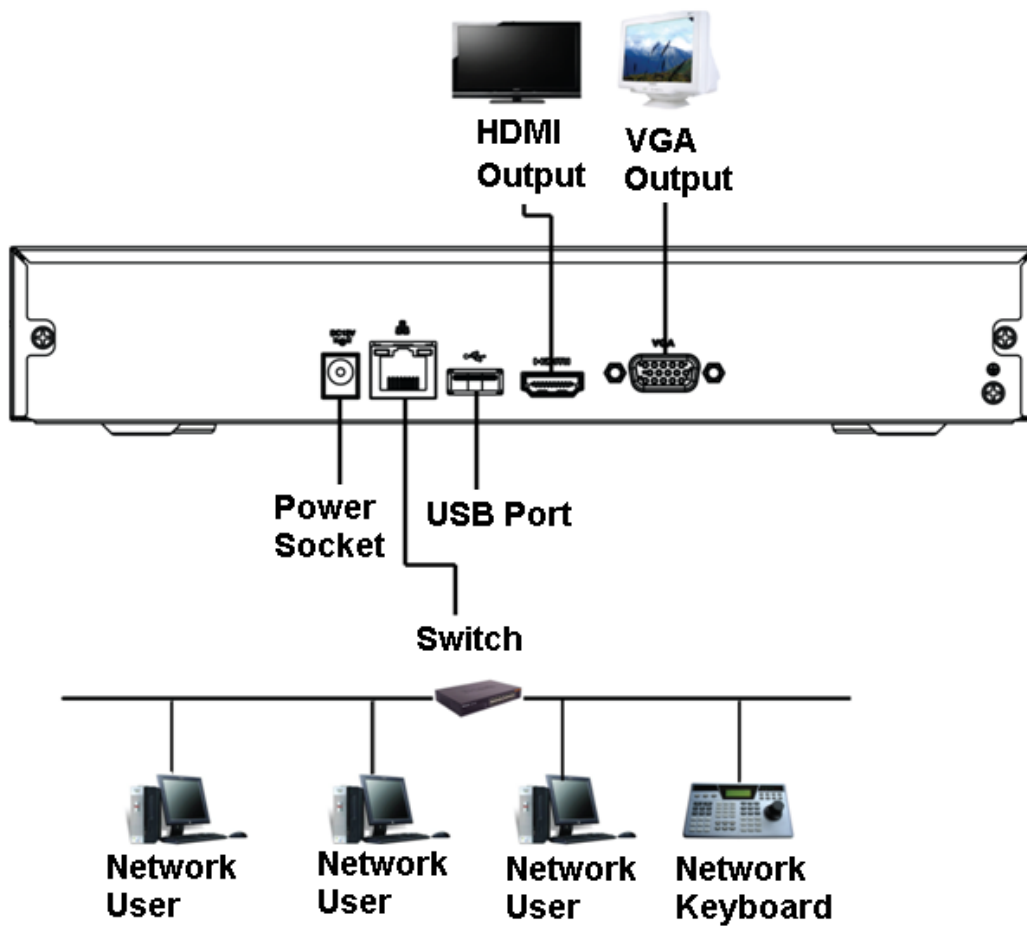

Figure 3-4

3.5.5 NVR41HS-W-S2 Series

Please refer to Figure 3-5 for connection sample.

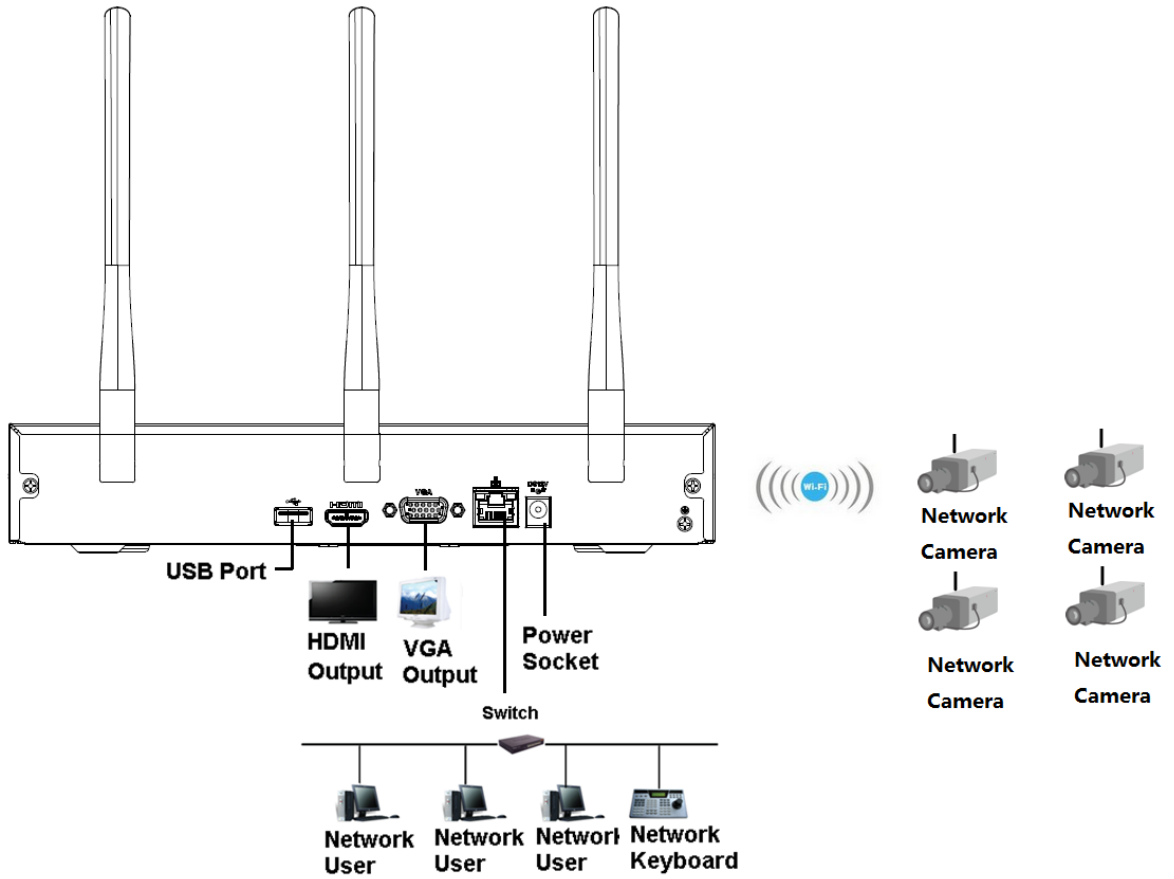

Figure 3-5

3.5.6 NVR21HS-S2/21HS-P-S2/21HS-8P-S2/41HS-4KS2/41HS-P-4KS2/41HS-8P-4KS2 Series

Please refer to Figure 3-6 for connection sample.

Please note the following figure is based on the NVR21HS-8P-S2.

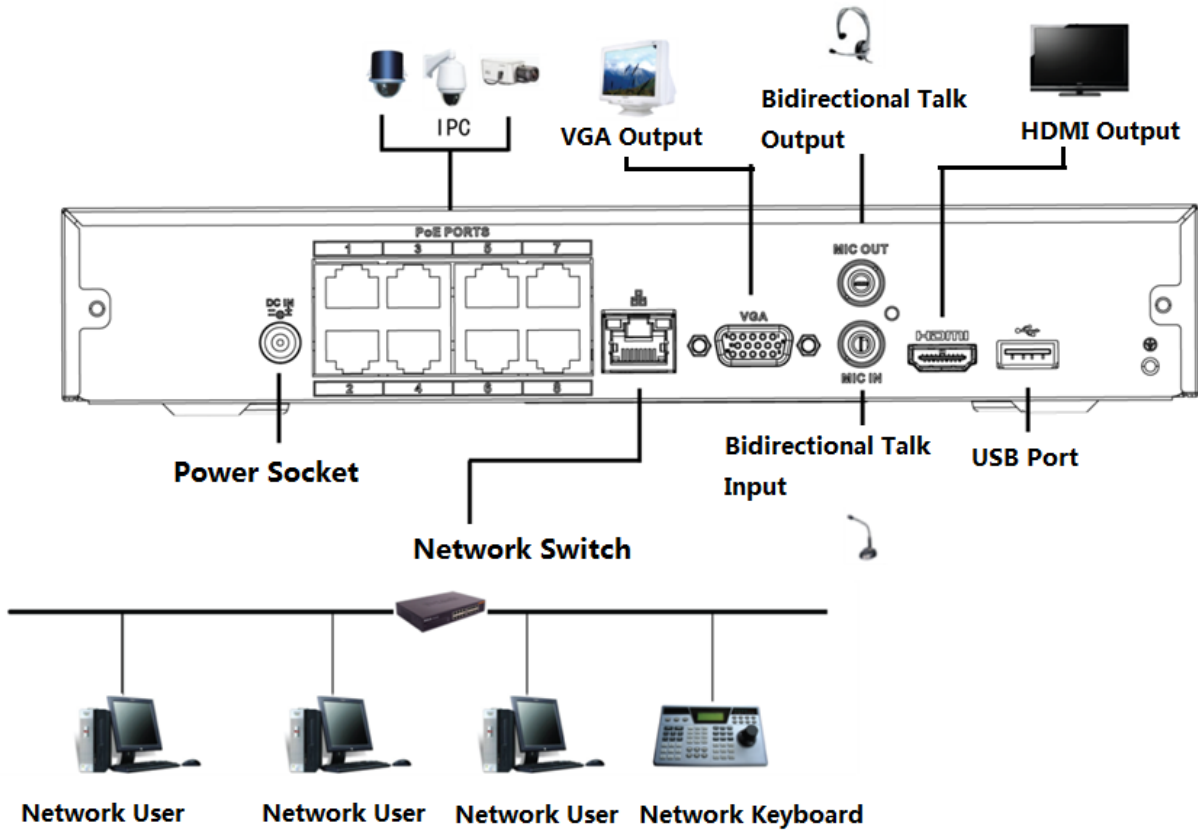

Figure 3-6

3.5.7 NVR22-S2/22-P-S2/22-8P-S2 Series

Please refer to Figure 3-7 for connection sample.

Please note the following figure is based on the NVR22-8P-S2.

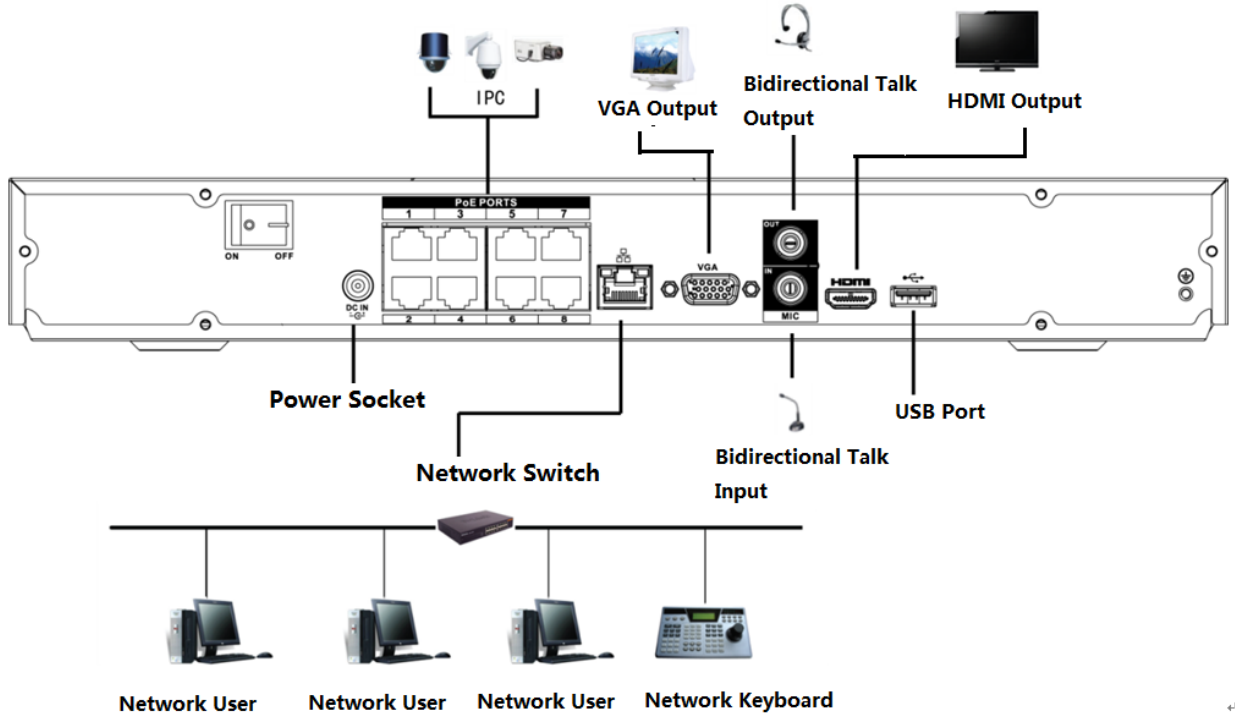

Figure 3-7

3.5.8 NVR42N Series

Please refer to Figure 3-8 for connection sample.

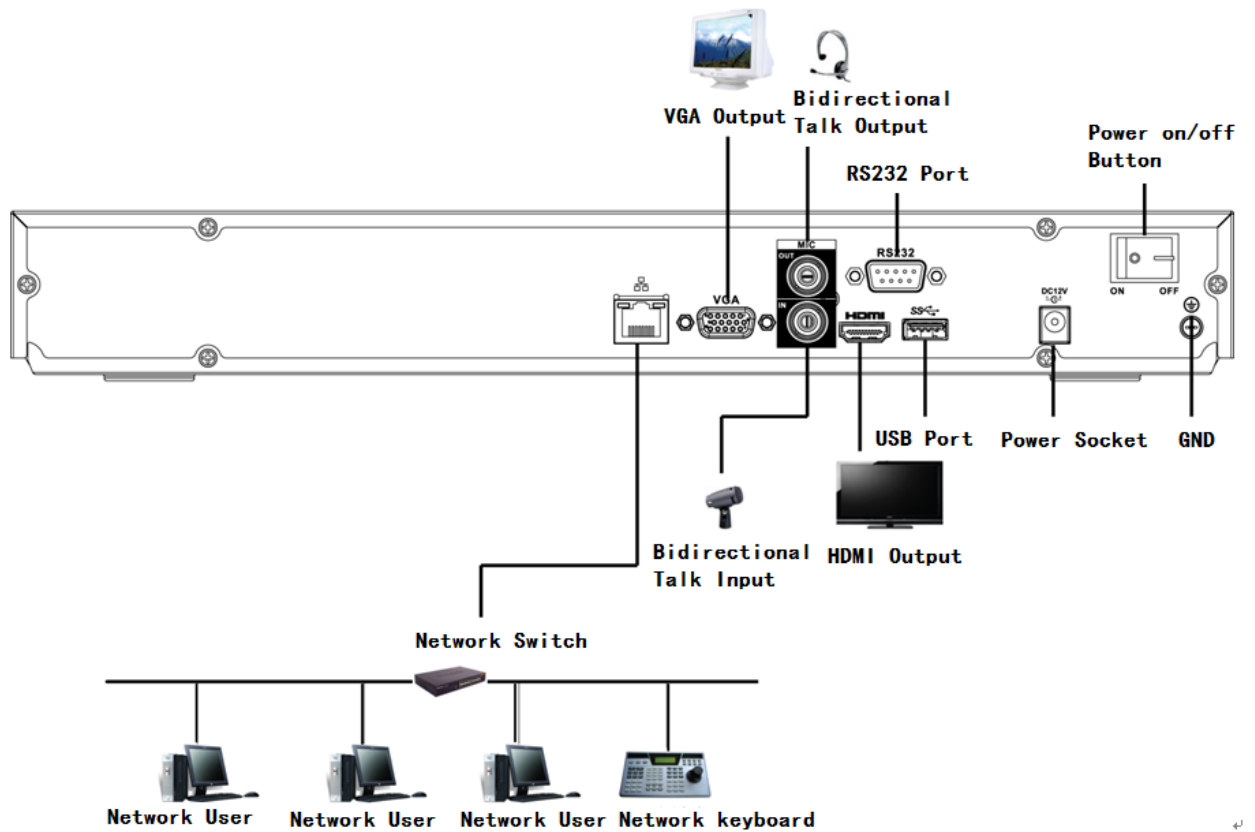

Figure 3-8

3.5.9 NVR42/42-P/42-8P/42-16P/52-4KS2/52-8P-4KS2/52-16P-4KS2 Series

Please refer to Figure 3-9 for connection sample.

The following figure is based on our 42-8P series product.

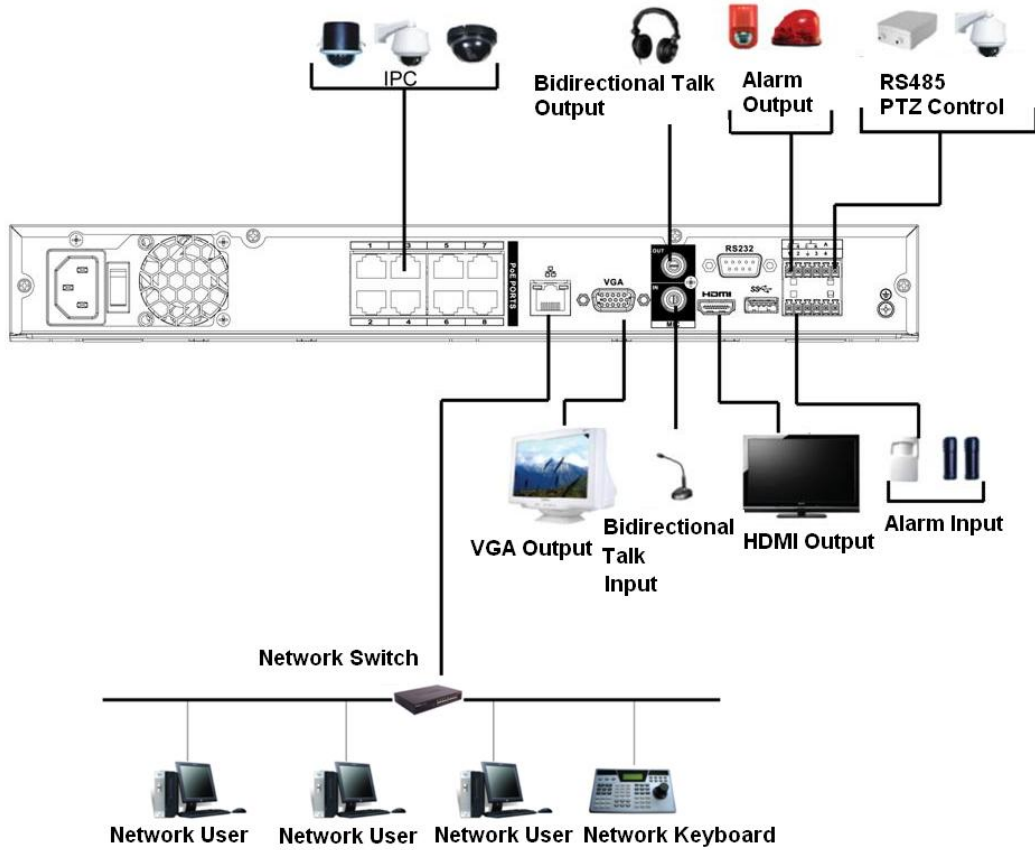

Figure 3-9

3.5.10 NVR42-4K/42-4KS2 Series

Please refer to Figure 3-10 for connection sample.

The following figure is based on our 42-4K series product.

3.5.12 NVR44-4K/48-4K/54-4KS2/54-16P-4KS2/58-4KS2/58-16P-4KS2 Series

Please refer to Figure 3-11 for connection sample.

The following interface is based on the 44-4K series product.

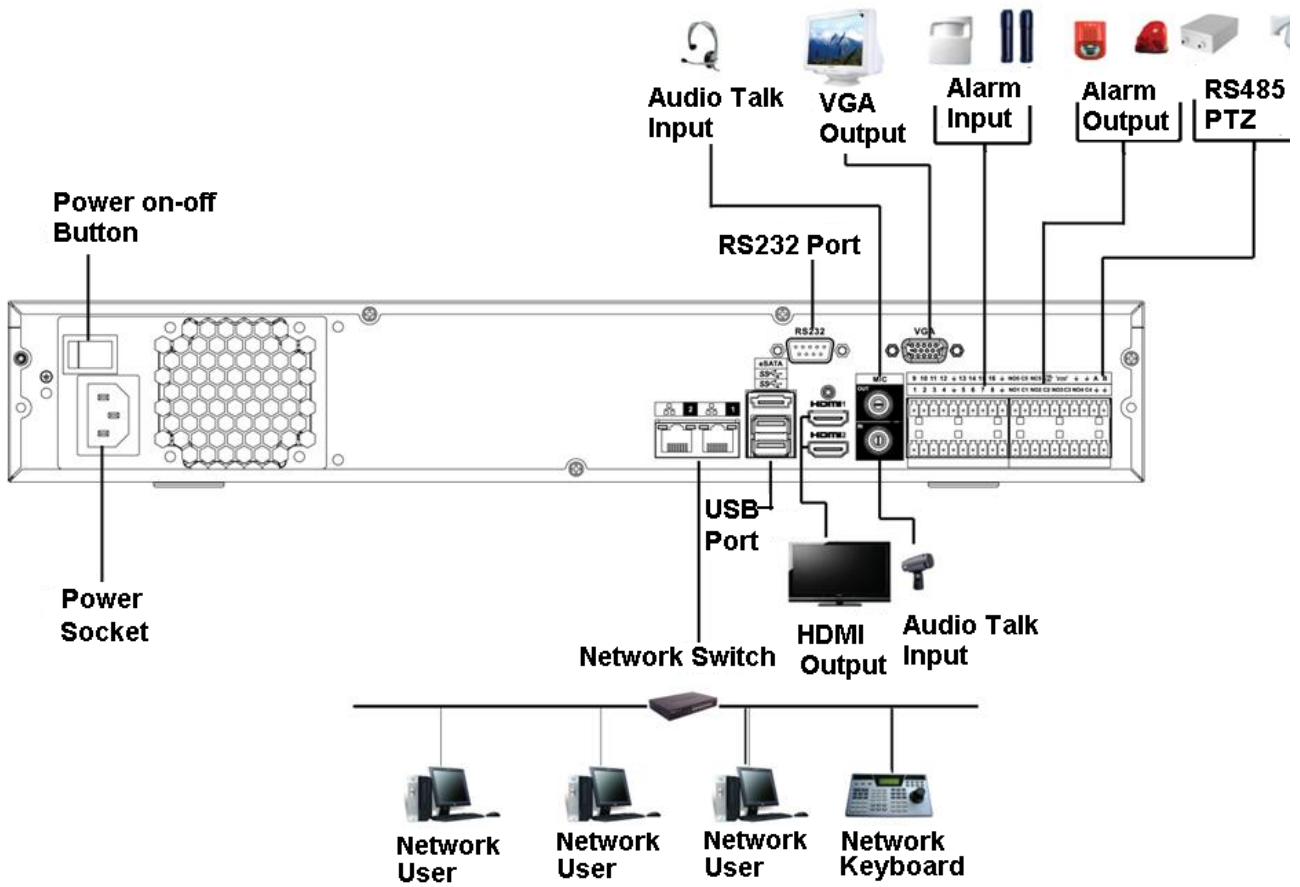

Figure 3-12

3.5.13 NVR44/44-8P/44-16P/44-4KS2/44-16P-4KS2 Series

Please refer to Figure 3-13 for connection sample.

The following interface is based on the 44-8P series product.

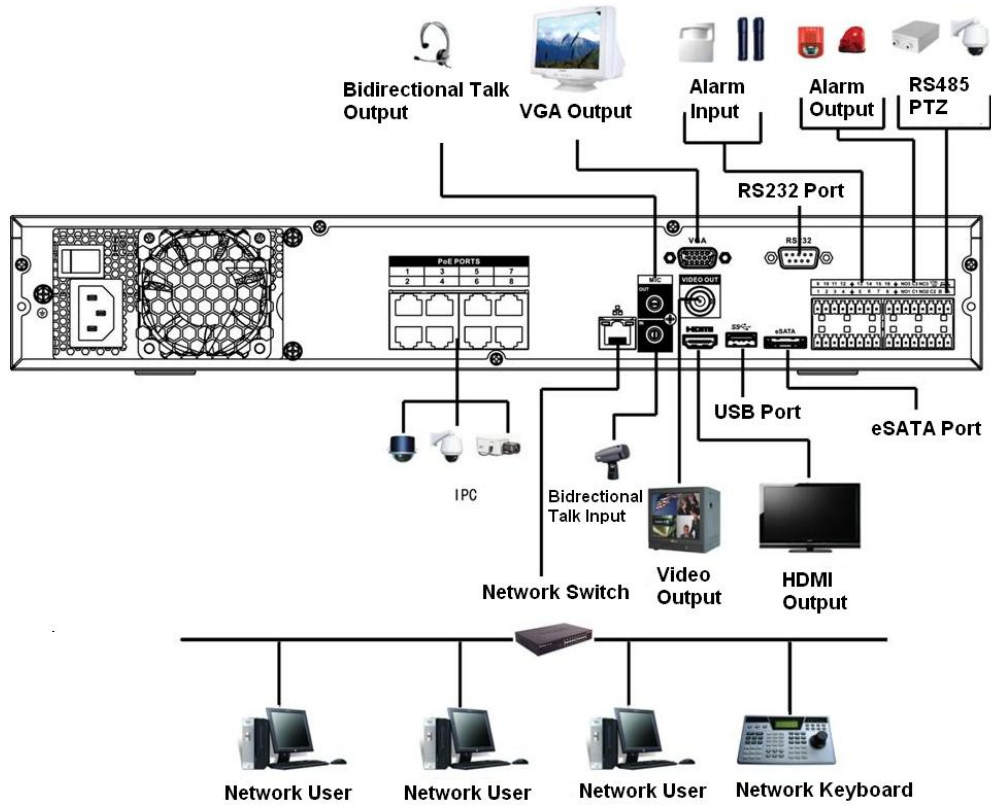

Figure 3-13

3.5.14 NVR48/48-16P/48-4KS2/48-16P-4KS2 Series

Please refer to Figure 3-14 for connection sample.

The following interface is based on the 48-16P series product.

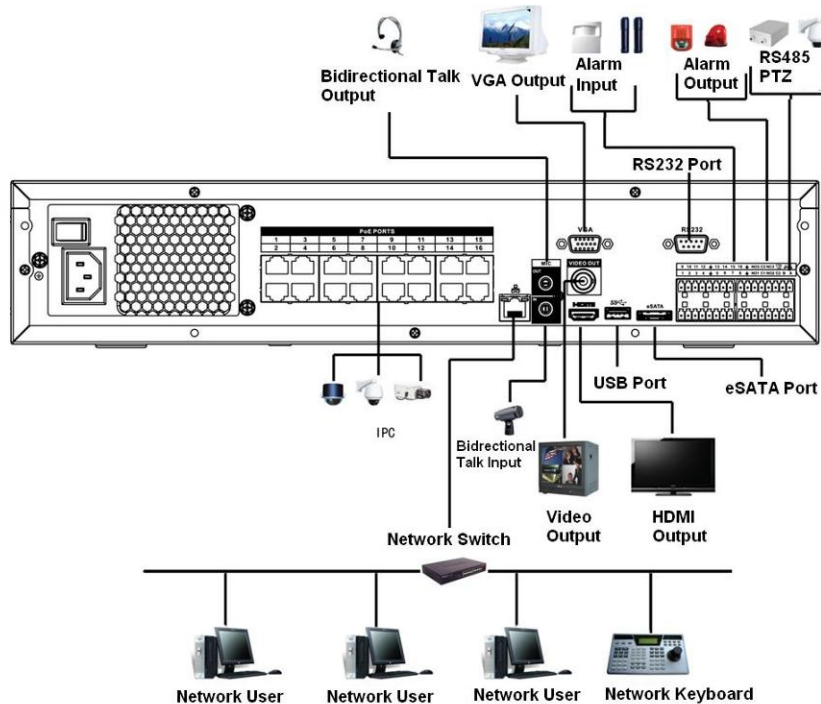

Figure 3-14

3.5.15 NVR72 Series

Please refer to Figure 3-15 for connection sample.

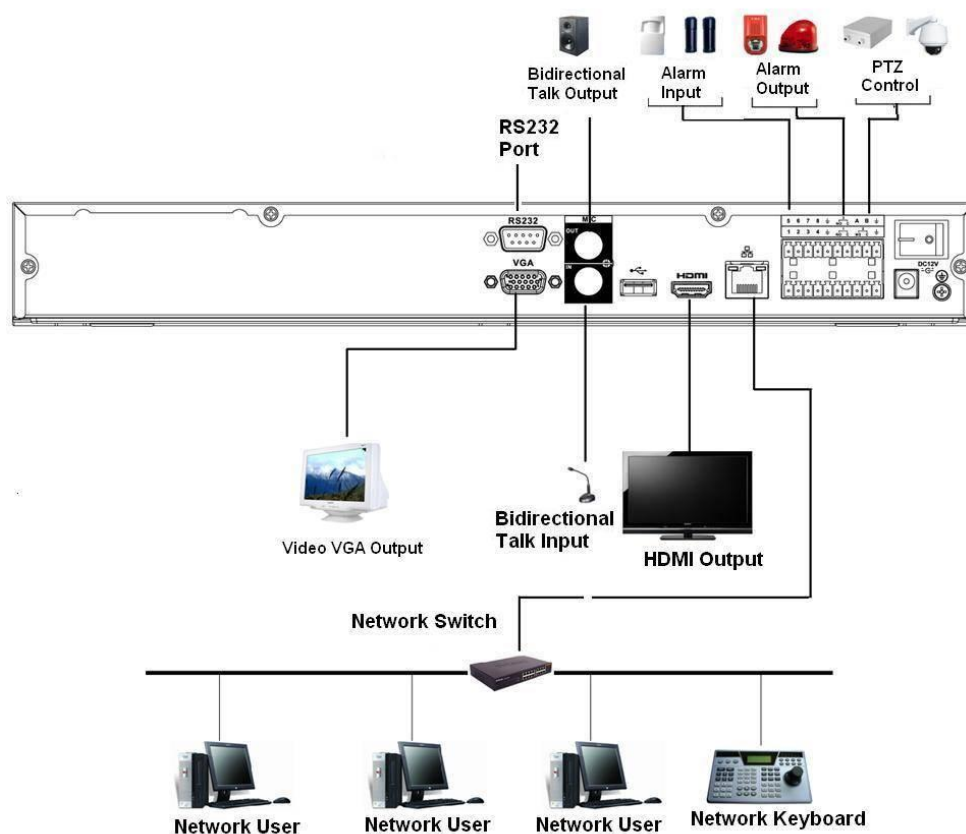

Figure 3-15

3.5.16 NVR72-8P Series

Please refer to Figure 3-16 for connection sample.

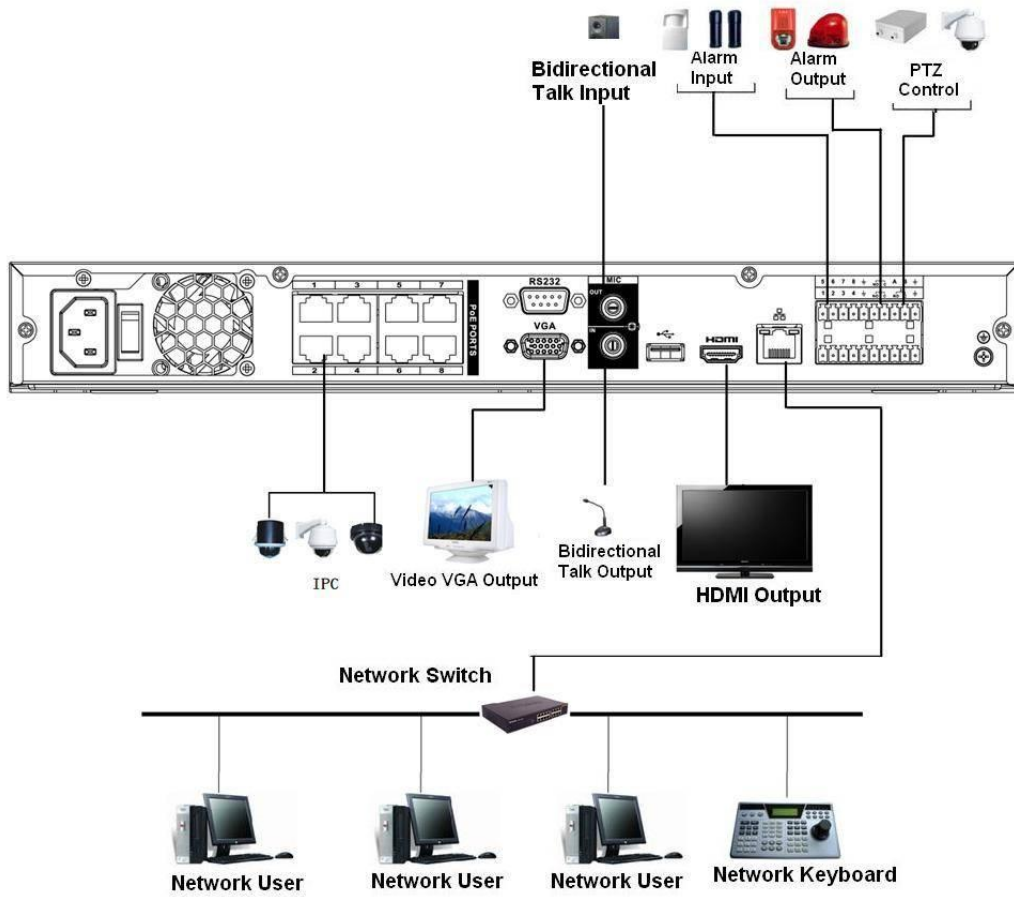

Figure 3-16

3.5.17 NVR74 Series

Please refer to Figure 3-17 for connection sample.

The following figure is based on the 74 series product.

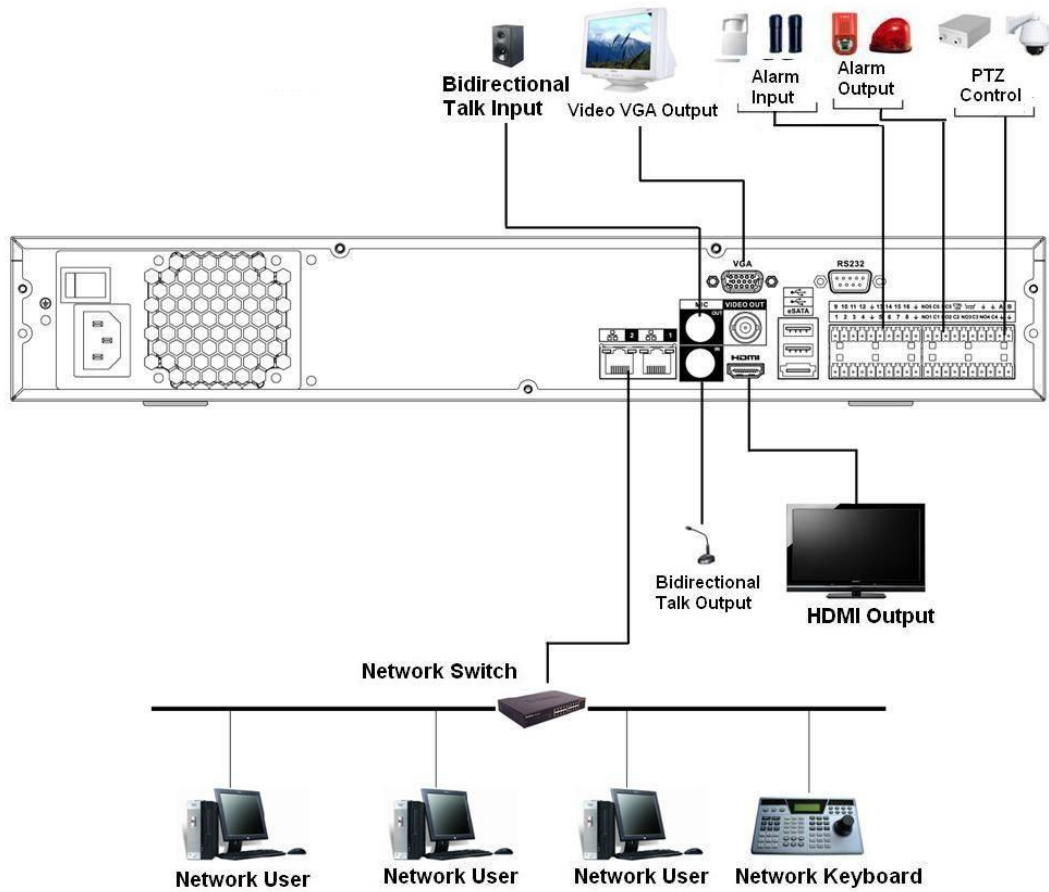

Figure 3-17

3.5.18 NVR74-8P/74-16P Series

Please refer to Figure 3-18 for connection sample.

The following figure is based on the NVR74-8P series product.

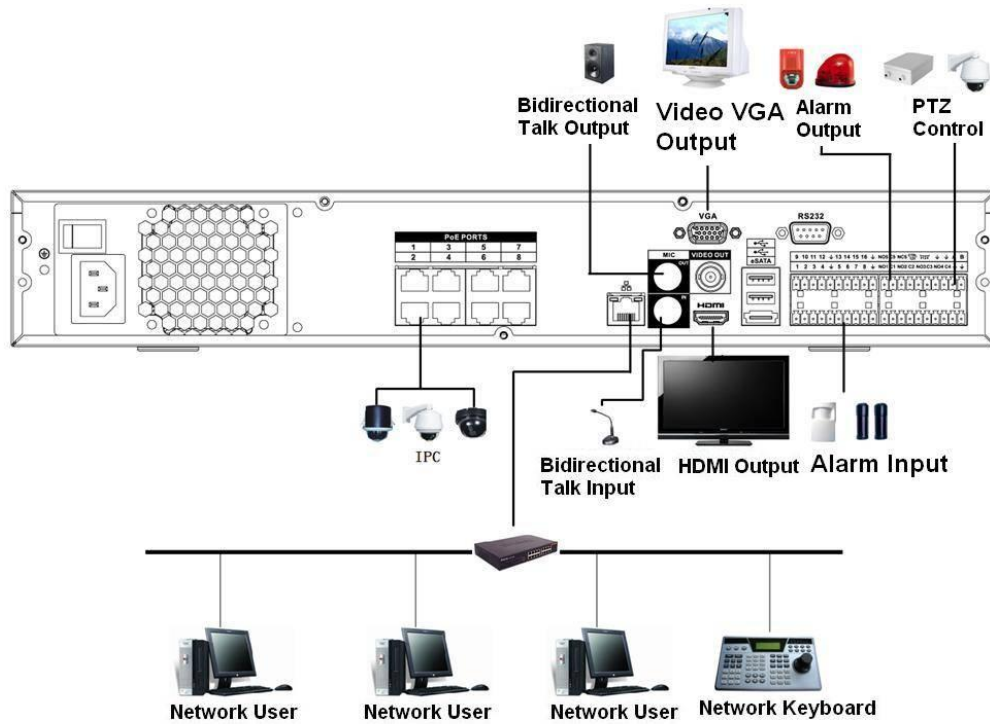

Figure 3-18

3.5.19 NVR78 Series

Please refer to Figure 3-19 for connection sample.

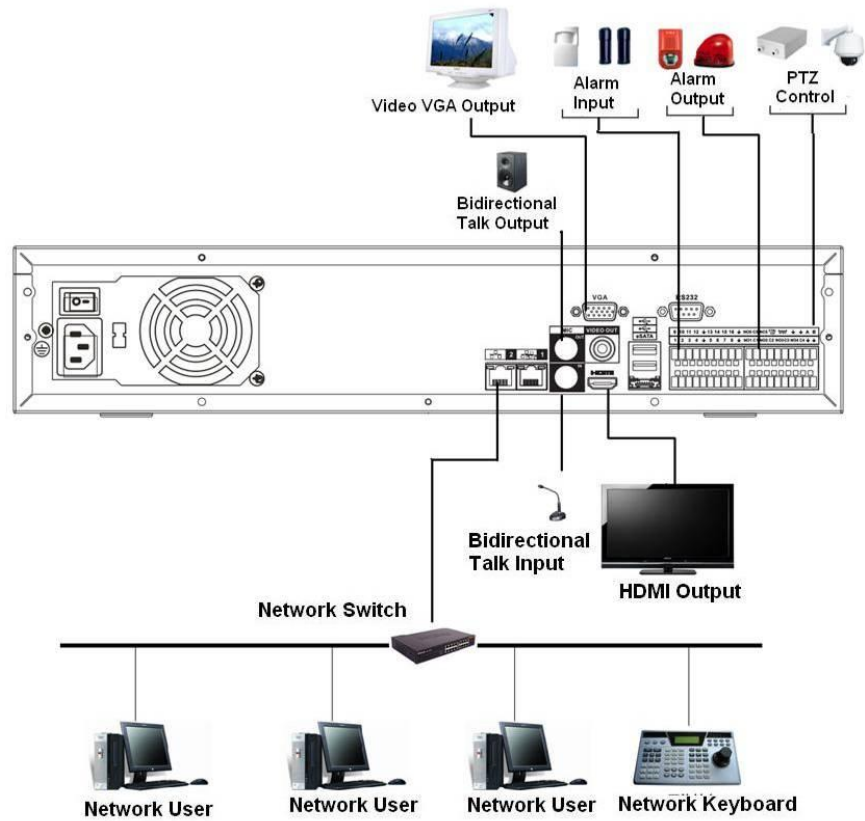

Figure 3-19

3.5.20 NVR78-16P Series

Please refer to Figure 3-20 for connection sample.

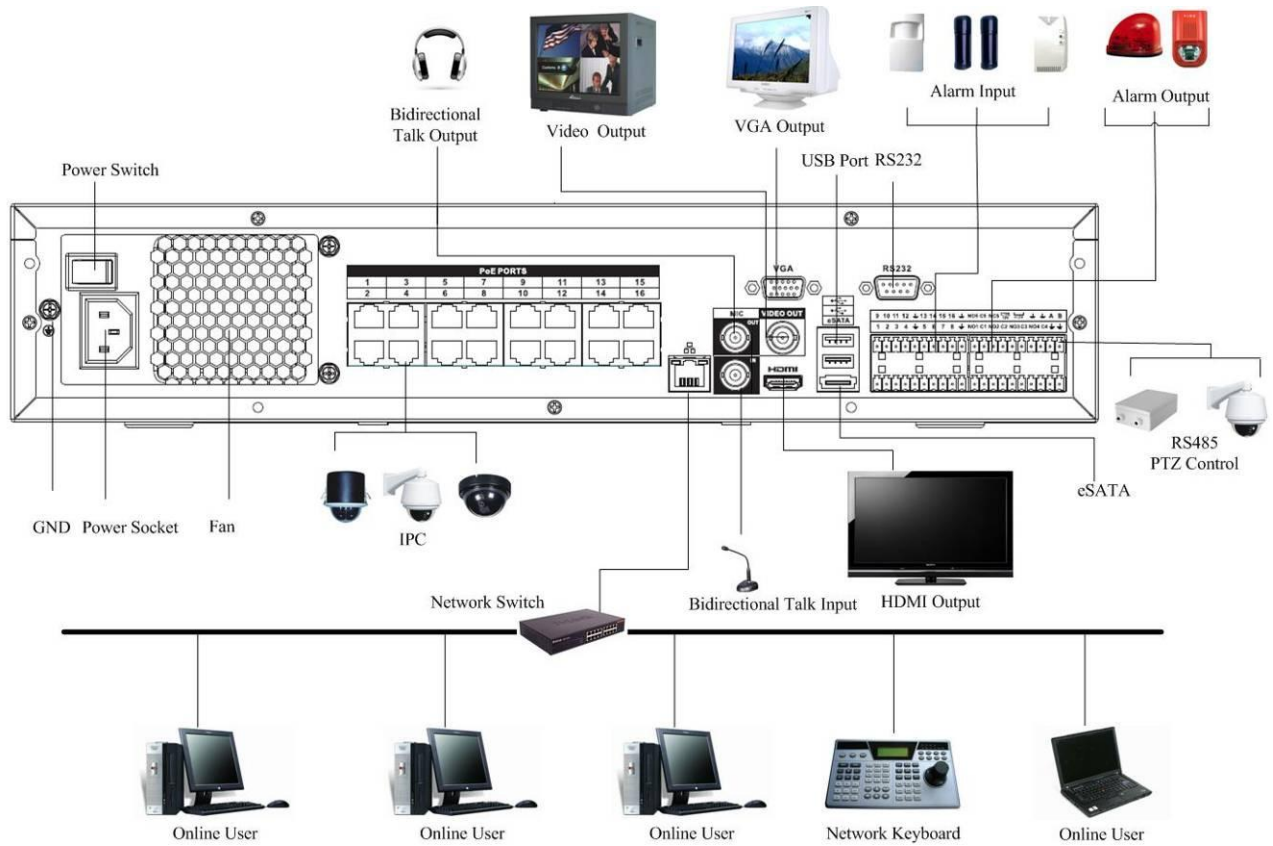

Figure 3-20

3.5.21 NVR78-RH Series

Please refer to Figure 3-21 for connection sample.

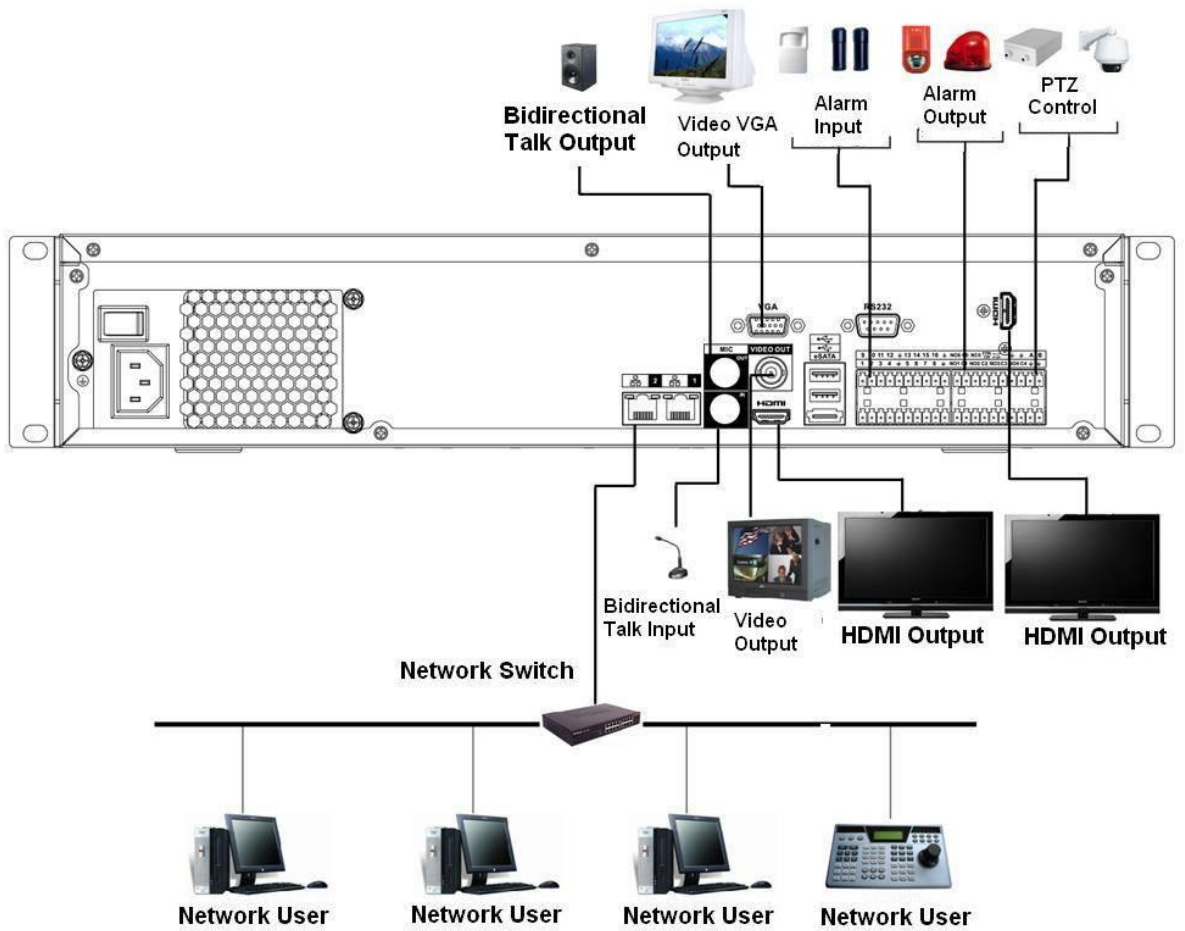

Figure 3-21

3.5.22 NVR70 Series

Please refer to Figure 3-22 for connection sample.

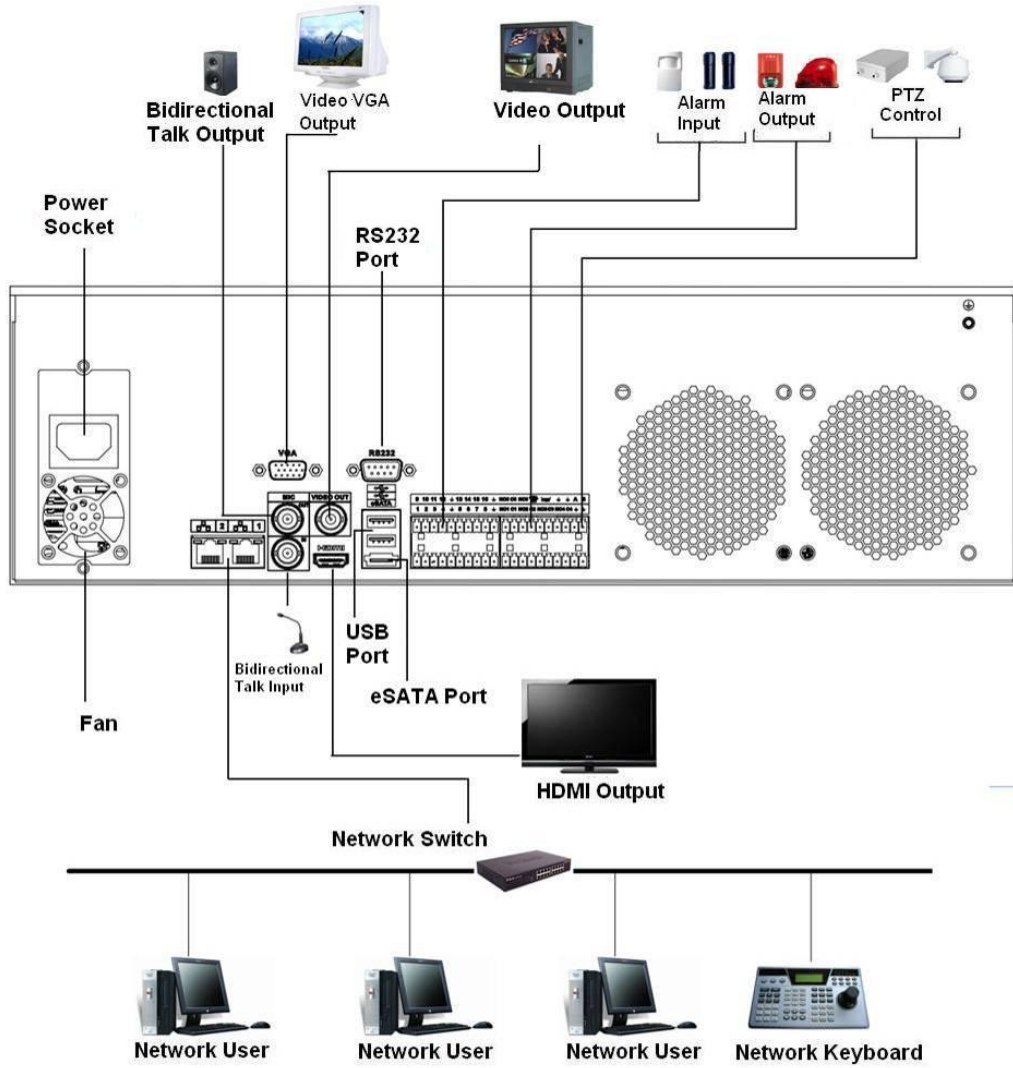

Figure 3-22

3.5.23 NVR70-R Series

Please refer to Figure 3-23 for connection sample.

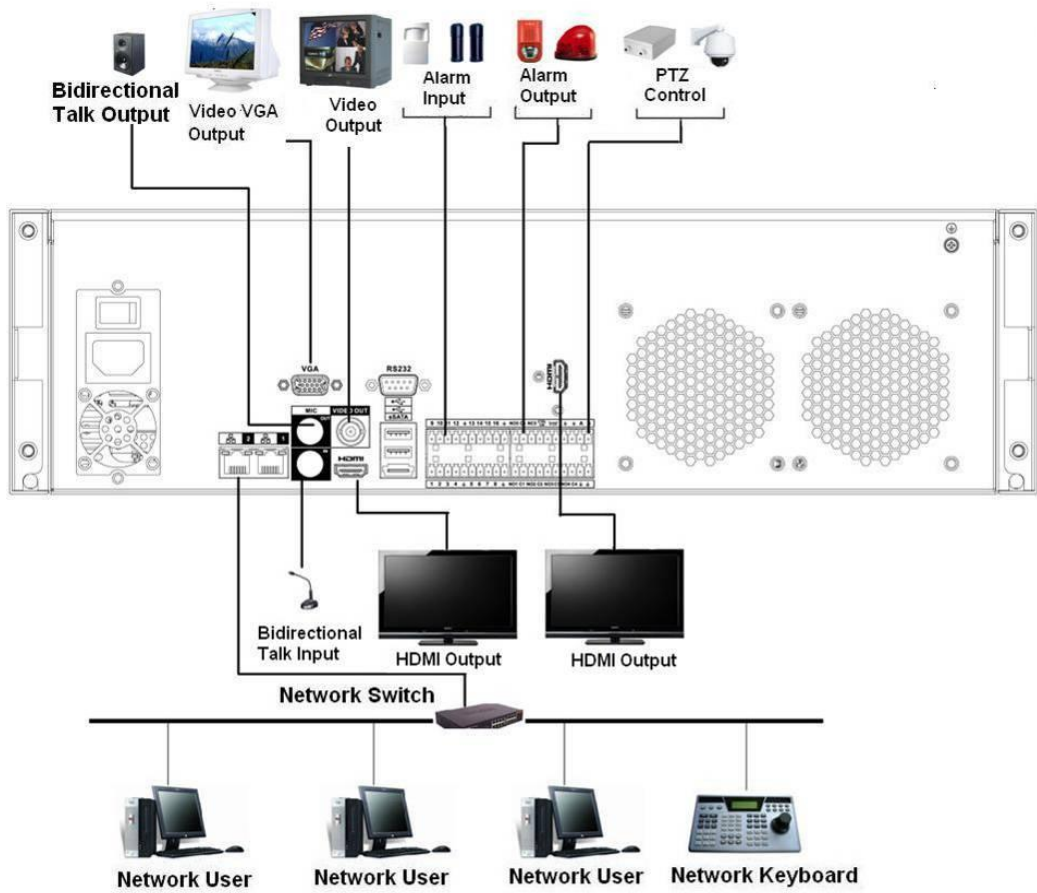

Figure 3-23

3.5.24 NVR42V-8P Series

Please refer to Figure 3-24 for connection sample.

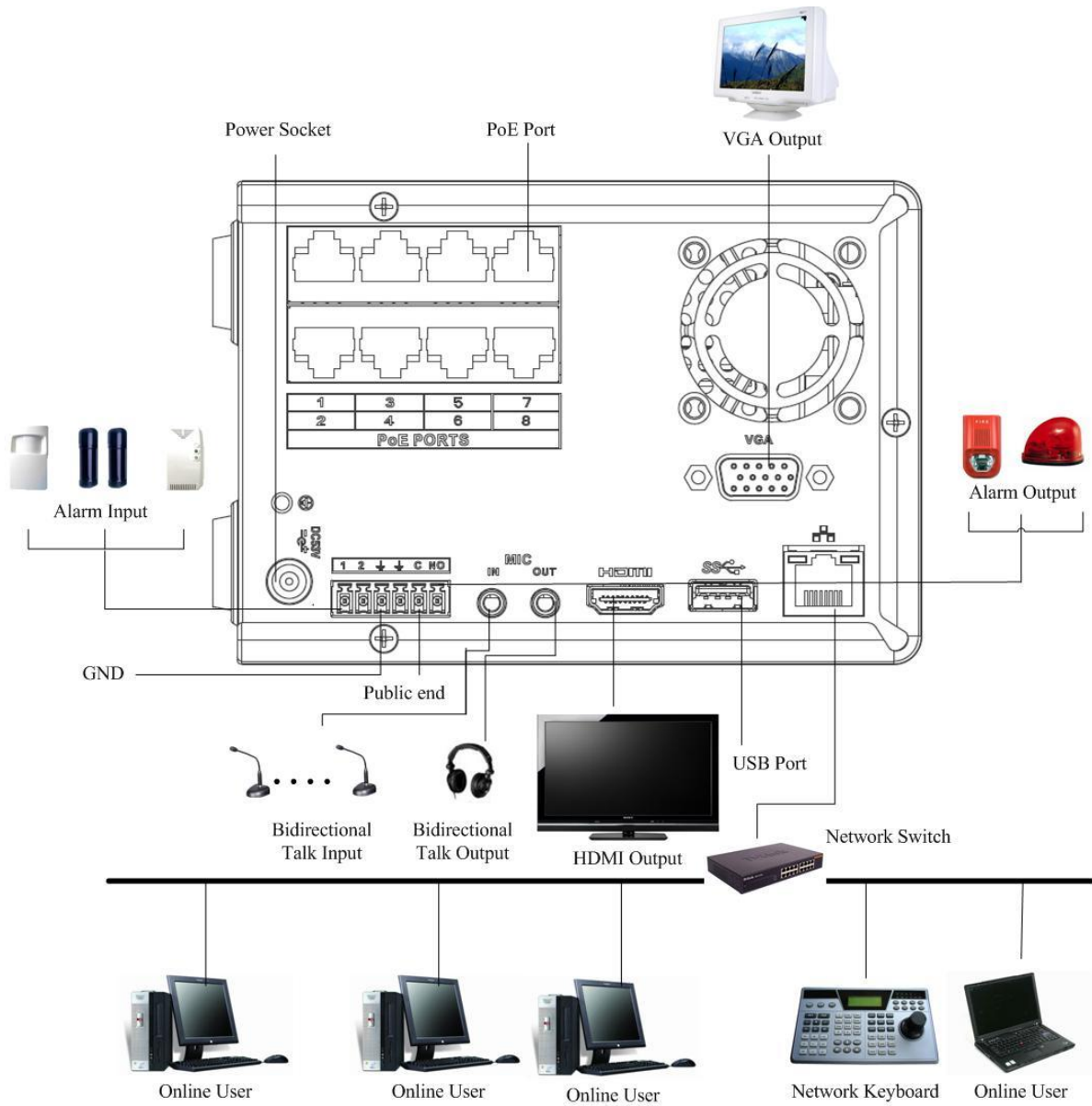

Figure 3-24

4 Local Basic Operation

4.1 Boot up and Shutdown

4.1.1 Boot up



Caution

Before the boot up, please make sure:

- For device security, please connect the NVR to the power adapter first and then connect the device to the power socket.
- The rated input voltage matches the device power on-off button. Please make sure the power wire connection is OK. Then click the power on-off button.
- Always use the stable current, if necessary UPS is a best alternative measure.

Please follow the steps listed below to boot up the device.

- Connect the device to the monitor and then connect a mouse.
- Connect power cable.
- Click the power button at the front or rear panel and then boot up the device. After device booted up, the system is in multiple-channel display mode by default.

4.1.2 Shutdown

Note

- When you see corresponding dialogue box “System is shutting down...” Do not click power on-off button directly.
- Do not unplug the power cable or click power on-off button to shutdown device directly when device is running (especially when it is recording.)

There are three ways for you to log out.

- a) Main menu (**RECOMMENDED**)

From Main Menu->Shutdown, select shutdown from dropdown list.

Click OK button, you can see device shuts down.

- b) From power on-off button on the front panel or remote control.

Press the power on-off button on the NVR front panel or remote control for more than 3 seconds to shutdown the device.

- c) From power on-off button on the rear panel.

4.2 Change/Reset Password

4.2.1 Change Password

For your own safety, please change your administrator default password after your first login.

After system booted up, you can see the following interface if it is your first login or you have restored default setup. See Figure 4-1. Please input old password and then input new password twice to confirm the change.

- The default administrator user name is **admin** and the password is **admin**.
- You can set security questions here to reset the password in case you forgot. System supports customized setup. Please note you need to set two security questions at the same time. When you reset the password, you need to answer these two security questions too.

- For reset information, please refer to chapter 4.2.2.



The image shows a web interface titled "ADMIN SECURITY". It contains several input fields: "User Name" with a dropdown menu showing "admin"; "Old Password", "New Password", and "Confirm Password" as text boxes; "Secure Question" with two dropdown menus: "Question 1" showing "What's your favorite pet?" and "Question 2" showing "What's your first car model?"; and "Answer" text boxes for each question. At the bottom, there are "OK" and "Cancel" buttons.

Figure 4-1

Click Cancel button, system pops up the following interface for you to confirm. See Figure 4-2. Check the box here, system will not pop up the change password interface the next time.

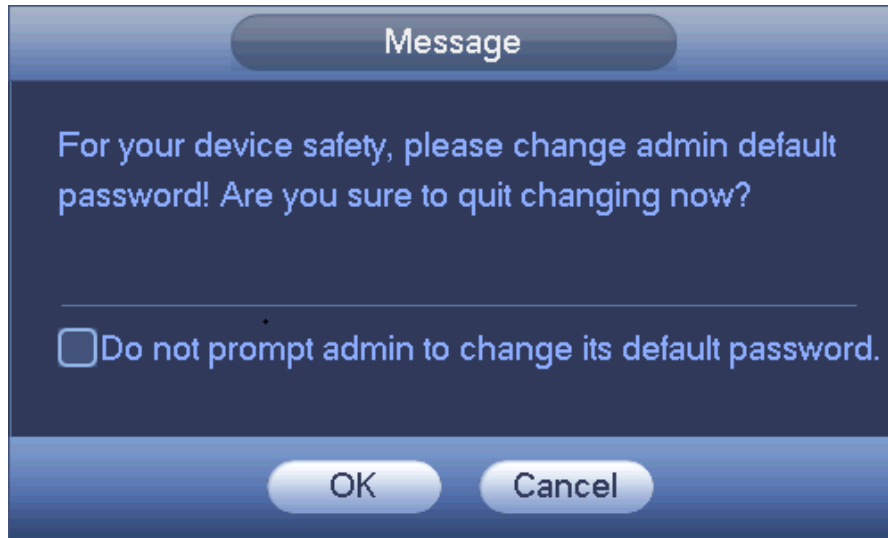

The image shows a "Message" dialog box with a dark blue background. The text inside reads: "For your device safety, please change admin default password! Are you sure to quit changing now?". Below the text is a horizontal line and a checkbox with the label "Do not prompt admin to change its default password.". At the bottom, there are "OK" and "Cancel" buttons.

Figure 4-2

4.2.2 Reset Password

Once you forgot password, you can answer the security questions you set in chapter 4.2.1 to reset the password.

In login interface, click . See Figure 4-3.

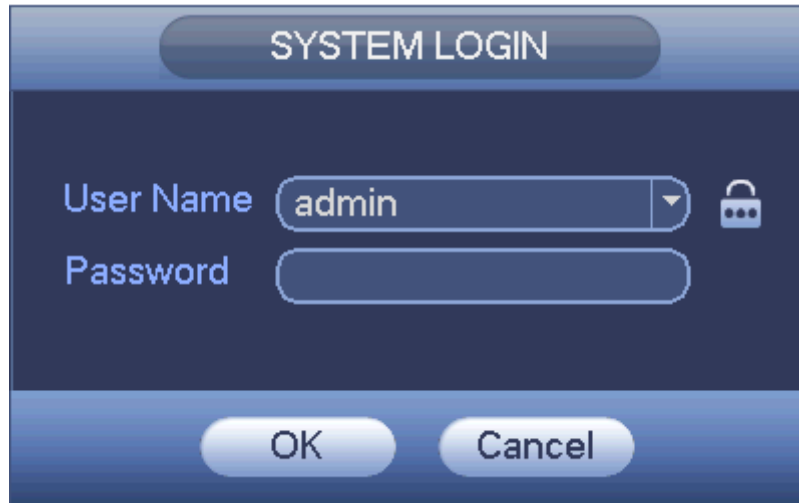

Figure 4-3

System pops up the following dialogue box, please answer the security questions and then input the new password twice. See Figure 4-4.



Figure 4-4

4.3 Startup Wizard

After device successfully booted up, it goes to startup wizard. Click Cancel/Next button, you can see system goes to login interface.

Tips

Check the box Startup button here, system goes to startup wizard again when it boots up the next time. Cancel the Startup button, system goes to the login interface directly when it boots up the next time.



Figure 4-5

Click Smart add, Cancel button or Next button, system goes to login interface. See Figure 4-6.

System consists of three accounts:

- **Username:** admin. **Password:** admin. (administrator, local and network)
- **Username:** 888888. **Password:** 888888. (administrator, local only)
- **Username:** default. **Password:** default (hidden user). Hidden user “default” is for system interior use only and can not be deleted. When there is no login user, hidden user “default” automatically login. You can set some rights such as monitor for this user so that you can view some channel view without login.

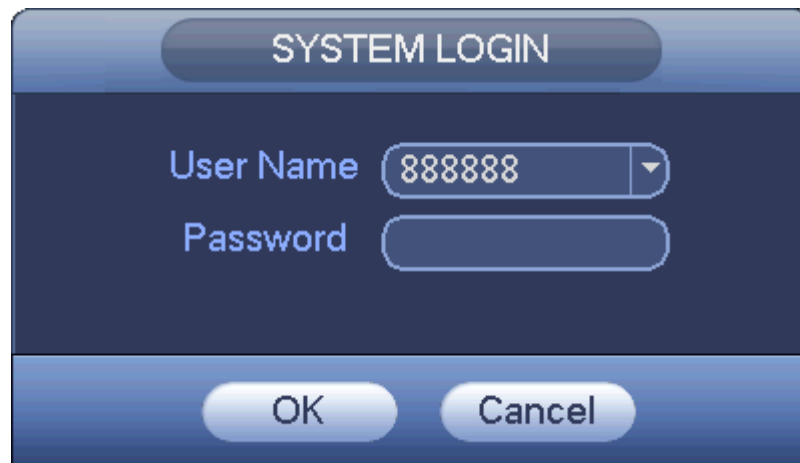

Figure 4-6

Note:

For security reason, please modify password after you first login.

Within 30 minutes, three times login failure will result in system alarm and five times login failure will result in account lock!

For detailed smart add information, please refer to chapter 4.5.

Click OK button, you can go to General interface. See Figure 4-7.

For detailed information, please refer to chapter 4.16.1.

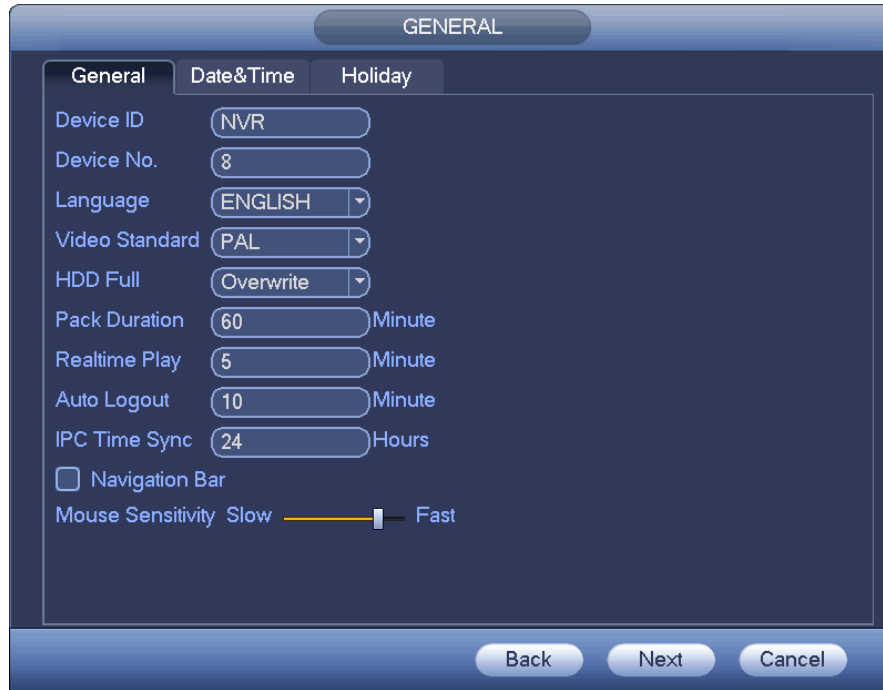

Figure 4-7

Click Next button, you can go to network interface. See Figure 4-8.
For detailed information, please refer to chapter 4.14.



Figure 4-8

Click Next button, you can set P2P function. Scan the QR code, download the App to the cellphone, you can use the smart phone to add the device. See Figure 4-9.
For detailed information, please refer to chapter 4.14.1.16.



Figure 4-9

Click Next button, you can go to remote device interface. See Figure 4-10.
For detailed information, please refer to chapter 4.5.



Figure 4-10

Click Next button, you can go to Schedule interface. See Figure 4-11.
 For detailed information, please refer to chapter 4.10.2.

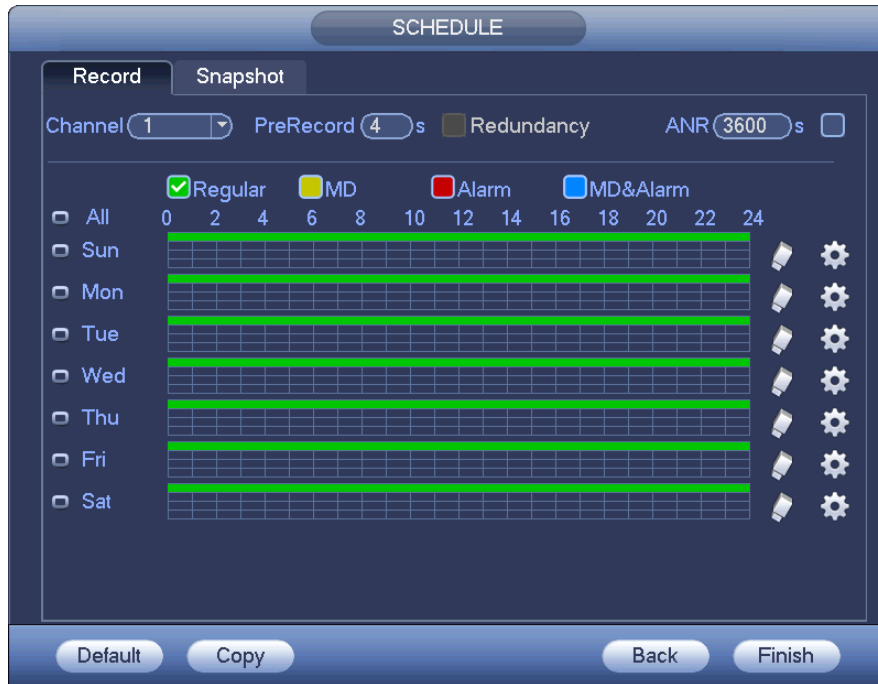

Figure 4-11

Click Finish button, system pops up a dialogue box. Click the OK button, the startup wizard is complete. See Figure 4-12.

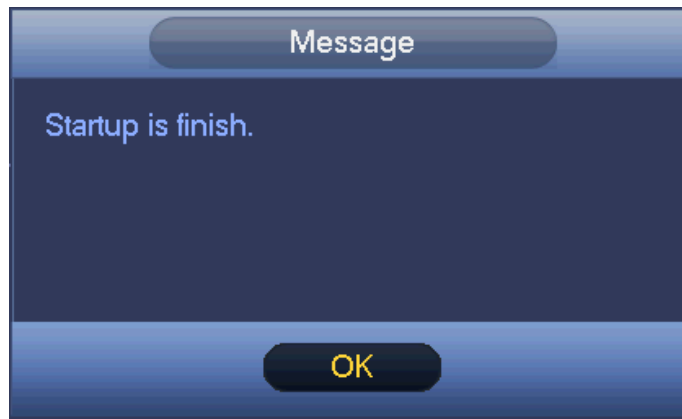

Figure 4-12

4.4 Navigation Bar

You need to go to the Main menu->Setting->System->General to enable navigation bar function; otherwise you can not see the following interface.

The navigation bar is shown as below. See Figure 4-13.



Figure 4-13

4.4.1 Main Menu

Click button  to go to the main menu interface.

4.4.2 Dual-screen operation

Important

This function is for some series only.

Click  to select screen 2, you can view an interface shown as below. See Figure 4-14. It is a navigation bar for screen 2.



Figure 4-14

Click any screen split mode; HDMI2 screen can display corresponding screens. Now you can control two screens. See Figure 4-15.



Figure 4-15

Note

- Screen 2 function is null if tour is in process. Please disable tour function first,
- Right now, the screen 2 operation can only be realized on the navigation bard. The operations on the right-click menu are for screen 1 only.

4.4.3 Output Screen

Select corresponding window-split mode and output channels.

4.4.4 Tour

Click button  to enable tour, the icon becomes , you can see the tour is in process.

4.4.5 PTZ

Click , system goes to the PTZ control interface. Please refer to chapter 4.9.2.

4.4.6 Color

Click button , system goes to the color interface. Please refer to chapter 4.7.4.1.

Please make sure system is in one-channel mode.

4.4.7 Search

Click button , system goes to search interface. Please refer to chapter 4.11.2

4.4.8 Alarm Status



Click button , system goes to alarm status interface. It is to view device status and channel status.

Please refer to chapter 4.17.1.4.

4.4.9 Channel Info



Click button , system goes to the channel information setup interface. It is to view information of the corresponding channel. See Figure 4-16.

Channel	Motion	Video Loss	Tampering	Record	Status	Record Mode	Resolution	Frame Rate	Bit Rate(K)
1	●	▲	●	■	■	Manual	960*576	25	95
2	●	▲	●	■	■	Regular	960*576	25	23
3	●	▲	●	■	■	Regular	960*576	25	95
4	●	▲	●	■	■	Regular	960*576	25	69
5	●	▲	●	■	■	Regular	960*576	25	23
6	●	▲	●	■	■	Regular	960*576	25	70
7	●	▲	●	■	■	Regular	960*576	25	68
8	●	▲	●	■	■	Regular	960*576	25	70
9	●	▲	●	■	■	Regular	960*576	25	70
10	●	▲	●	■	■	Regular	960*576	25	120
11	●	▲	●	■	■	Regular	960*576	25	69
12	●	▲	●	■	■	Regular	960*576	25	71
13	●	▲	●	■	■	Regular	960*576	25	71
14	●	▲	●	■	■	Regular	960*576	25	70
15	●	▲	●	■	■	Regular	960*576	25	70
16	●	▲	●	■	■	Regular	960*576	25	71
17	●	●	●	■	■	Regular	1920*1080	25	8071
18	●	●	●	■	■	Regular	1280*960	25	4062
19	--	--	--	■	■	Regular	1280*720	30	0

Figure 4-16

4.4.10 Registration



Click , system goes to the registration interface. Please refer to chapter 4.5.

4.4.11 Network



Click , system goes to the network interface. It is to set network IP address, default gateway and etc. Please refer to chapter 4.14.

4.4.12 HDD Manager



Click , system goes to the HDD manager interface. It is to view and manage HDD information. Please refer to chapter 4.15.1.

4.4.13 USB Manager



Click , system goes to the USB Manager interface. It is to view USB information, backup and update. Please refer to chapter 4.12.1 file backup, chapter 4.12.3 backup log, chapter 4.12.2 import/export, and chapter 4.17.5 upgrade for detailed information.

4.5 Smart Add

When the network camera(s) and the NVR are in the same router or switch, you can use smart add function to add all network cameras to the NVR at the same time.

There are two ways for you to go to the smart add interface.

- From the startup wizard, click Smart add button. See Figure 4-17.



Figure 4-17

- On the preview interface, right click mouse and then select Smart add. See Figure 4-18.

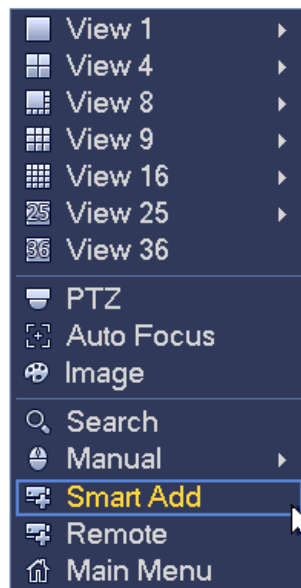

Figure 4-18

Now you can go to the smart add interface. See Figure 4-19.



Figure 4-19

Click smart add button, you can see device enables DHCP function. See Figure 4-20.



Figure 4-20

System pops up the following interface for you to confirm IP information if there are several IP segments. See Figure 4-21.

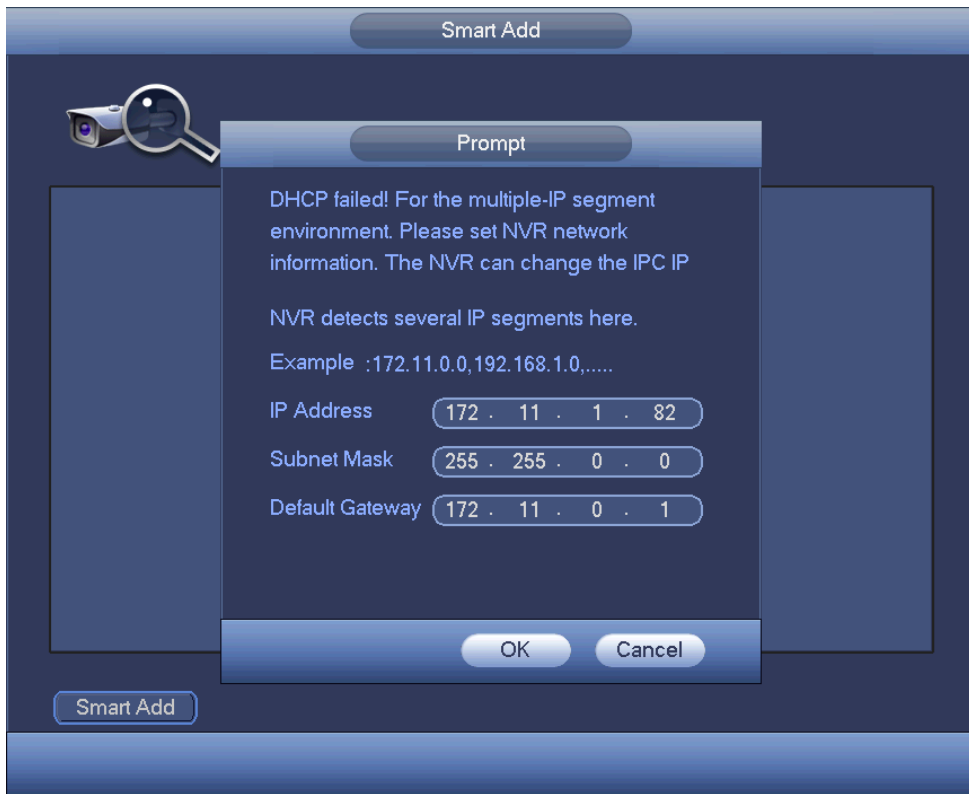

Figure 4-21

Now you can see system is auto adding IPC to the corresponding channels. See Figure 4-22.



Figure 4-22

You can see the following dialog box after system successfully added network cameras. See Figure 4-23.



Figure 4-23

4.6 Camera

4.6.1 Registration

From Main menu->Setting->Camera->Registration, you can see the following interface. See Figure 4-24.







- Device search: Click the button; you can search all network cameras in the same network segment.
- Channel: It is the device channel number. If you have not added the network camera, the channel number is shown as .
- Status: Red circle () means current channel has no video, green circle () means current channel has video.
- IP address: It is to display network camera IP address.
- Type: There are two connection types. You can use the network to connect to the camera or use the WIFI. The  means current network camera connection mode is general; the  means current network camera mode is hotspot.
- Add/Delete: Click  to delete the device, click  to add the device to the NVR.
- Manual Add: Click Manual Add button, you can set the corresponding network camera information and then select the channel you want to add. The interface is similar to Figure 4-25.



Figure 4-24

- Modify: Click Modify button, you can see the following interface. See Figure 4-25.
- ✧ Name: Change current channel name.
- ✧ Protocol: Select protocol from the dropdown list.
- ✧ IP Address: Input IP address here.
- ✧ TCP port: Input TCP port value.
- ✧ User name/Password: Input user name and password. The default user name is **admin** and the default password is **admin**.
- ✧ Decoder butter: There are three options: realtime/fluent/default. Please select from the dropdown list.
- ✧ Channel: Current channel number.



The image shows a 'Manual Add' configuration window with the following fields:

Name	<input type="text"/>
Protocol	Private
IP Address	192.168.0.0
TCP Port	37777
Username	admin
Password	•••••
Decoder Buffer	Default
Channel	4

Buttons: Save, Cancel

Figure 4-25

4.6.2 Short-Cut Menu

In the preview interface, for the channel of no IPC connection, you can click the icon “+” in the centre of the interface to quickly go to the registration interface (Figure 4-24.). See Figure 4-26.

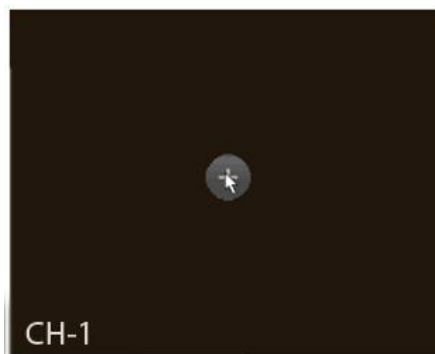

Figure 4-26

4.6.3 Image

From main menu->setting->camera->image, you can see the image interface is shown as below. See Figure 4-27.

- Channel: Select a channel from the dropdown list.
- Saturation: It is to adjust monitor window saturation. The value ranges from 0 to 100. The default value is 50. The larger the number, the strong the color is. This value has no effect on the general brightness of the whole video. The video color may become too strong if the value is too high. For the grey part of the video, the distortion may occur if the white balance is not accurate. Please note the video may not be attractive if the value is too low. The recommended value ranges from 40 to 60.

- Brightness: It is to adjust monitor window bright. The value ranges from 0 to 100. The default value is 50. The larger the number is, the bright the video is. When you input the value here, the bright section and the dark section of the video will be adjusted accordingly. You can use this function when the whole video is too dark or too bright. Please note the video may become hazy if the value is too high. The recommended value ranges from 40 to 60.
- Contrast: It is to adjust monitor window contrast. The value ranges from 0 to 100. The default value is 50. The larger the number is, the higher the contrast is. You can use this function when the whole video bright is OK but the contrast is not proper. Please note the video may become hazy if the value is too low. If this value is too high, the dark section may lack brightness while the bright section may over exposure .The recommended value ranges from 40 to 60.
- Auto Iris: It is for the device of the auto lens. You can check the box before ON to enable this function. The auto iris may change if the light becomes different. When you disable this function, the iris is at the max. System does not add the auto iris function in the exposure control. This function is on by default.
- Mirror: It is to switch video up and bottom limit. This function is disabled by default.
- Flip: It is to switch video left and right limit. This function is disabled by default.
- BLC: It includes several options: BLC/WDR/HLC/OFF.
- ✧ BLC: The device auto exposures according to the environments situation so that the darkest area of the video is cleared
- ✧ WDR: For the WDR scene, this function can lower the high bright section and enhance the brightness of the low bright section. So that you can view these two sections clearly at the same time. The value ranges from 1 to 100. When you switch the camera from no-WDR mode to the WDR mode, system may lose several seconds record video.
- ✧ HLC: After you enabled HLC function, the device can lower the brightness of the brightest section according to the HLC control level. It can reduce the area of the halo and lower the brightness of the whole video.
- ✧ OFF: It is to disable the BLC function. Please note this function is disabled by default.
- Profile: It is to set the white balance mode. It has effect on the general hue of the video . This function is on by default. You can select the different scene mode such as auto, sunny, cloudy, home, office, night, disable and etc to adjust the video to the best quality.
- ✧ Auto: The auto white balance is on. System can auto compensate the color temperature to make sure the vide color is proper.
- ✧ Sunny: The threshold of the white balance is in the sunny mode.
- ✧ Night: The threshold of the white balance is in the night mode.
- ✧ Customized: You can set the gain of the red/blue channel. The value reneges from 0 to 100.
- Day/night. It is to set device color and the B/W mode switch. The default setup is auto.
- ✧ Color: Device outputs the color video.
- ✧ Auto: Device auto select to output the color or the B/W video according to the device feature (The general bright of the video or there is IR light or not.)
- ✧ B/W: The device outputs the black and white video.
- ✧ Sensor: It is to set when there is peripheral connected IR light.

Please note some non-IR series product support sensor input function.



Figure 4-27

4.6.4 Channel Name

From main menu->Setting->Camera-Channel name, you can see an interface shown as in Figure 4-28. It is to modify channel name. It max supports 31-character.

Please note you can only modify the channel name of the connected network camera.



Figure 4-28

4.6.5 Upgrade

Note

Right now, the NVR can upgrade the IPC via the USB device or WEB. You can upgrade 8 network cameras of the same model (or the NVR supported) at the same time.

It is to update the network camera.

From main menu->setting->camera->remote, the interface is shown as below. See Figure 4-29.

Click Browse button and then select the upgrade file. Then select a channel (or you can select device type filter to select several devices at the same time.)

Click Begin button to upgrade. You can see the corresponding dialogue once the upgrade is finish.

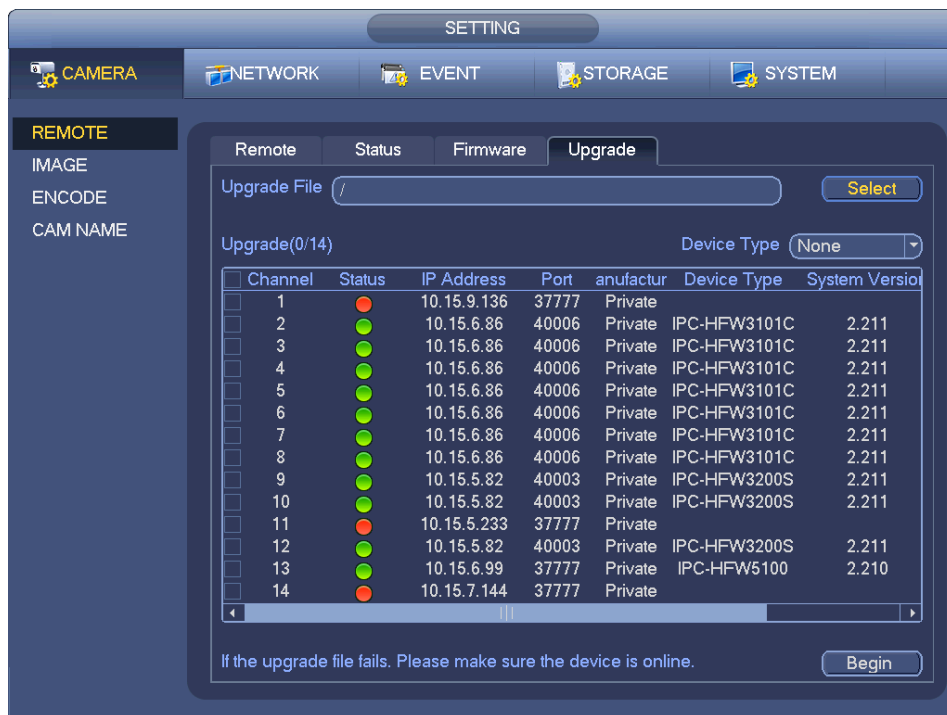

Figure 4-29

4.6.6 UPNP

Important

Do not connect the switch to the PoE port, otherwise the connection may fail!

Please connect the IPC to the PoE port of the device rear panel (Figure 4-30), system can auto connect to the network camera. Please note the following figure is for reference only.

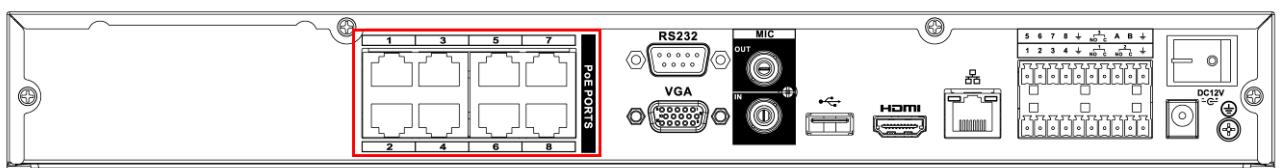

Figure 4-30

4.6.7 Built-in Switch Setup

The built-in switch function is for product of PoE port.

From Main menu->Setting->Network->Switch, you can set switch IP address, subnet mask, gateway and etc. See Figure 4-31.



Figure 4-31

4.7 Preview

After device booted up, the system is in multiple-channel display mode. See Figure 4-32. Please note the displayed window amount may vary. The following figure is for reference only. Please refer to chapter 1.3 Specifications for the window-amount your product supported.

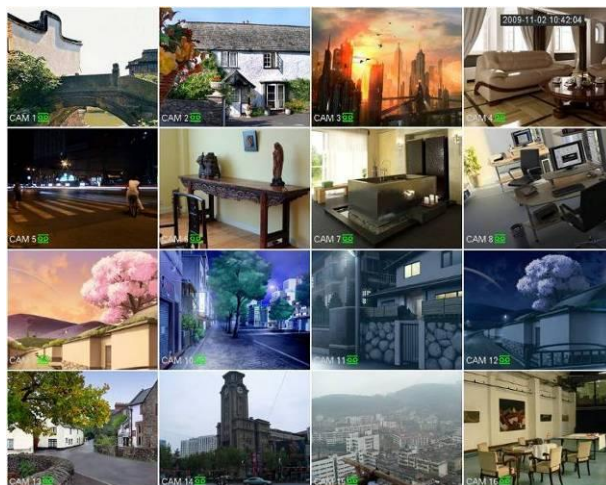

Figure 4-32

4.7.1 Preview

If you want to change system date and time, you can refer to general settings (Main Menu->Setting->System->General). If you want to modify the channel name, please refer to the display settings (Main Menu->Camera->CAM name)

Please refer to the following sheet for detailed information.

1		Recording status	3		Video loss
2		Motion detection	4		Camera lock

Tips

- Preview drag: If you want to change position of channel 1 and channel 2 when you are previewing, you can left click mouse in the channel 1 and then drag to channel 2, release mouse you can switch channel 1 and channel 2 positions.
- Use mouse middle button to control window split: You can use mouse middle button to switch window split amount.

4.7.2 Preview control interface

Move you mouse to the top centre of the video of current channel, you can see system pops up the preview control interface. See Figure 4-33. If your mouse stays in this area for more than 6 seconds and has no operation, the control bar automatically hides.

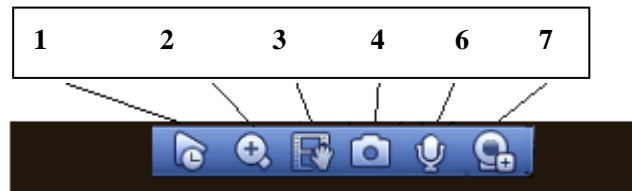

Figure 4-33 Digital Channel

1) Realtime playback

It is to playback the previous 5-60 minutes record of current channel.

Please go to the Main menu->Setting->->System->General to set real-time playback time.

System may pop up a dialogue box if there is no such record in current channel.

2) Digital zoom

It is to zoom in specified zone of current channel. It supports zoom in function of multiple-channel.

Click button , the button is shown as .

There are two ways for you to zoom in.

- Drag the mouse to select a zone, you can view an interface show as Figure 4-34.



Figure 4-34

- Put the middle button at the centre of the zone you want to zoom in, and move the mouse, you can view an interface shown as in Figure 4-35.



Figure 4-35

Right click mouse to cancel zoom and go back to the original interface.

3) Manual record function



It is to backup the video of current channel to the USB device. System can not backup the video of multiple-channel at the same time.



Click button , system begins recording. Click it again, system stops recording. You can find the record file on the flash disk.

4) Manual Snapshot

Click  to snapshot 1-5 times. The snapshot file is saved on the USB device or HDD. You can go to the Search interface (chapter 4.11) to view.

5) Bidirectional talk

If the connected front-end device supports bidirectional talk function, you can click this button. Click button  to start bidirectional talk function the icon now is shown as . Now the rest bidirectional talk buttons of digital channel becomes null too.

Click  again, you can cancel bidirectional talk and the bidirectional talk buttons of other digital channels become as .

6) Registration

Shortcut menu. Click it to go to the registration interface to add/delete remote device or view its corresponding information. Please refer to chapter 4.6.2 for detailed information.

4.7.3 Right Click Menu

After you logged in the device, right click mouse, you can see the short cut menu. Please see Figure 4-36.

- Window split mode: You can select window amount and then select channels.
- PTZ: Click it to go to PTZ interface.
- Fish eye(optional): It is to realize fish eye operation.
- Auto focus: It is to set auto focus function. Please make sure the connected network camera supports this function.
- Color setting: Set video corresponding information.

- Search: Click it to go to Search interface to search and playback a record file.
- Record control: Enable/disable record channel.
- Alarm output: It is to set alarm output mode.
- Camera registration: Search and add a remote device.
- Alarm output: Generate alarm output signal manually.
- Main menu: Go to system main menu interface.

Tips:

Right click mouse to go back to the previous interface.

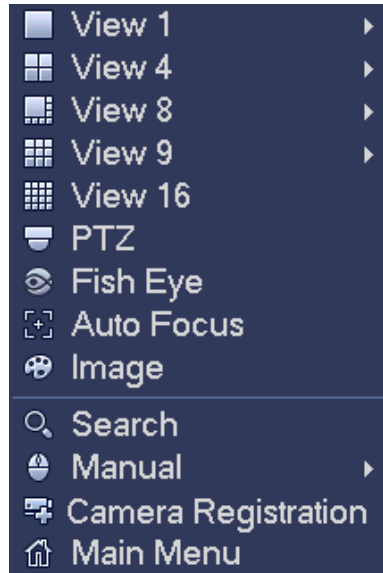

Figure 4-36

4.7.4 Preview Display Effect Setup

4.7.4.1 Video Color

Here you can set hue, brightness, contrast, saturation, gain, white level, color mode and etc. See Figure 4-37.



Figure 4-37

Please refer to the following sheet for detailed information.

Item	Note
Period	There are two periods in one day. You can set different sharpness, brightness, and contrast setup for different periods.
Effective Time	Check the box here to enable this function and then set period time.
Sharpness	The value here is to adjust the edge of the video. The value ranges from 0 to 100. The larger the value is, the clear the edge is and vice versa. Please note there is noise if the value here is too high. The default value is 50 and the recommended value ranges from 40 to 60.
Brightness	<p>It is to adjust monitor window bright. The value ranges from 0 to 100. The default value is 50.</p> <p>The larger the number, the bright the video is. When you input the value here, the bright section and the dark section of the video will be adjusted accordingly. You can use this function when the whole video is too dark or too bright. Please note the video may become hazy if the value is too high. The recommended value ranges from 40 to 60.</p>
Contrast	<p>It is to adjust monitor window contrast. The value ranges from 0 to 100. The default value is 50.</p> <p>The larger the number, the higher the contrast is. You can use this function when the whole video bright is OK but the contrast is not proper. Please note the video may become hazy if the value is too low. If this value is too high, the dark section may lack brightness while the bright section may over exposure. The recommended value ranges from 40 to 60.</p>
Saturation	<p>It is to adjust monitor window saturation. The value ranges from 0 to 100. The default value is 50.</p> <p>The larger the number, the strong the color is. This value has no effect on the general brightness of the whole video. The video color may become too strong if the value is too high. For the grey part of the video, the distortion may occur if the white balance is not accurate. Please note the video may not be attractive if the value is too low. The recommended value ranges from 40 to 60.</p>
Gain	The gain adjust is to set the gain value. The default value may vary due to different device models. The smaller the value, the low the noise. But the brightness is also too low in the dark environments. It can enhance the video brightness if the value is high. But the video noise may become too clear.
Color mode	It includes several modes such as standard, color, bright, gentle. Select a color mode, the sharpness, brightness, contrast and etc can automatically switch to corresponding setup.

4.7.4.2 Display

From Main Menu->Setting->System->Display, you can go to the following interface. See Figure 4-38. Here you can set menu and video preview effect. All you operation here does not affect the record file and playback effect.



Figure 4-38

Now you can set corresponding information.

- Display the intelligent rule(s): Check the box to enable IVS function, system can display IVS rule on the preview interface. **Please note this function is for some series only.**
- Resolution: There are five options: 1280x1024 (Default), 1280x720, 1920x1080, 1024x768 and 3840x2160. Please note the system needs to reboot to activate current setup. **Please note 3840x2160 is for some series only.**

- **VGA+HDMI2:** It is for dual-screen operation. Please select from the dropdown list according to your actual situation. Click Apply button, system needs to restart to activate new setup. For example, 32+4 means for VGA, system max supports 32-window split and for HDMI2, system max supports 4-window split. **Please note this function is for some series only.**
- **Color mode:** Please select from the dropdown list. It is to set video color mode.
- **Transparency:** Here is for you to adjust menu transparency. The higher the value is, the better transparent the menu is.
- **Channel name:** Here is for you to modify channel name. System max support 25-digit (The value may vary due to different series). Please note all your modification here only applies to NVR local end. You need to open web or client end to refresh channel name.
- **Time display:** You can select to display time or not when system is playback.
- **Channel display:** You can select to channel name or not when system is playback.
- **Image enhance:** Check the box; you can optimize the margin of the preview video.
- **Original scale:** Check the box here to select a corresponding channel; it can restore video original scale.

Click OK button to save current setup.

4.7.4.3 TV adjust

Note

Some series product supports TV adjust function. This function is disabled by default.

From Main Menu->Setting->System->Display->TV adjust; you can go to the following interface. See Figure 4-38. Here you can set margins and brightness.



Figure 4-39

4.7.5 Preview Tour Parameters

Set preview display mode, channel display sequence and tour setup.

- Set preview display mode: On the preview interface, right click mouse, you can view right-click menu. Now you can select preview window amount and channel.
- Set channel display mode: On the preview interface, if you want to change channel 1 and channel 16 position, please right click channel 1 video window and then drag to the channel 16 video window, release button, you can change channel 1 and channel 16 position.
- Tour setup: Here you can set preview window channel display mode and interval. Please follow the steps listed below.

From Main menu->Setting->System->Display->Tour, you can see an interface shown as in Figure 4-40. Here you can set tour parameter.

- Enable tour: Check the box here to enable tour function. The general tour supports all types of window split mode.
- Interval: Input proper interval value here. The value ranges from 1-120 seconds.
- Motion tour type: System support 1/8-window tour. Please note you need to go to the main menu->Setting->Event->Video detect->Motion detect to enable tour function.
- Alarm tour type: System support 1/8-window tour. Please note you need to go to the main menu->Setting->Event->Alarm to enable tour function.
- Window split: It is to set window split mode.



Figure 4-40

Tips

On the navigation bar, click to enable/disable tour.
Click Save button to save current setup.

4.8 Fish eye (Optional)

Please note this function is for some series only.

4.8.1 Fish eye de-warp during preview interface

On the preview interface, select fish eye channel and then right click mouse, you can select fish eye. See

Figure 4-41.



Figure 4-41

Now you can see an interface shown as in Figure 4-42. You can set fish eye installation mode and display mode.

Note:

- For the non-fish eye channel, system pops up dialogue box to remind you it is not a fish eye channel and does not support de-warp function.
- If system resources are insufficient, system pops up the corresponding dialogue box too.

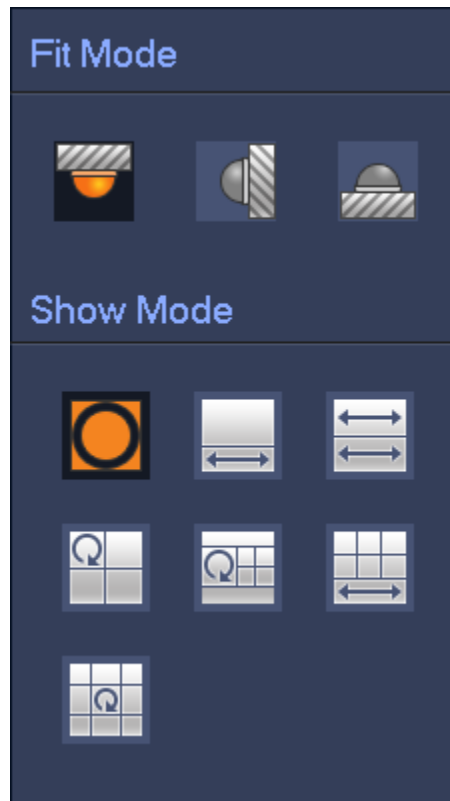

















Figure 4-42

There are three installation modes: ceiling mount/wall mount/ground mount. The different installations modes have different de-warp modes.

Please refer to the following sheet for detailed information.

Installation modes	Icon	Note
 (Ceiling mount)  (Ground mount)		360°panorama original view
		1 de-warp window+1 panorama stretching
		2 panorama stretching view
		1 360° panorama view+3 de-warp windows
		1 360°panorama view+4 de-warp windows
		4 de-warp windows+1 panorama stretching
		1 360° panorama view+8 de-warp windows
 (Wall mount)		360°panorama original view
		Panorama stretching
		1 panorama unfolding view+3 de-warp windows
		1 panorama unfolding view +4 de warp windows
		1 panorama unfolding view +8 de warp windows

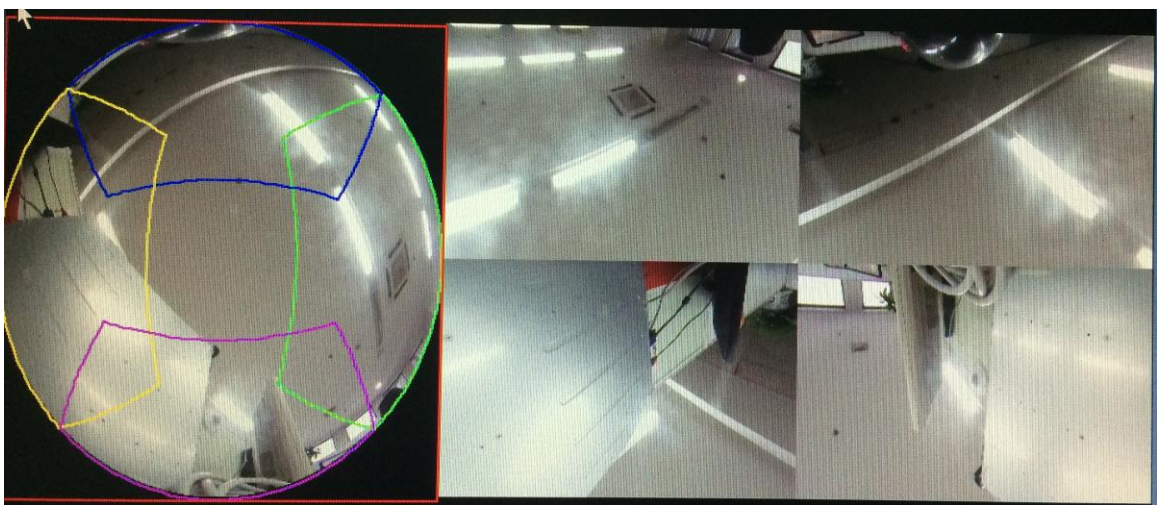



Figure 4-43

In Figure 4-43, you can adjust the color pane on the left pane or use your mouse to change the position of the small images on the right pane to realize fish eye de-warp.

4.8.2 Fish eye de-warp during playback

On the main menu, click search button.

Select 1-window playback mode and corresponding fish eye channel, click  to play.

Right click the , you can go to the de-warp playback interface. For detailed information, please refer to chapter 4.8.1.

4.9 PTZ

Note:

Before you control the PTZ, please make sure the PTZ decoder and the NVR network connection is OK and the corresponding settings are right.

4.9.1 PTZ Settings

Cable Connection

Please follow the procedures below to go on cable connection

- Connect the dome RS485 port to NVR RS485 port.
- Connect dome video output cable to NVR video input port.
- Connect power adapter to the dome.

In the main menu, from Setting->System->PTZ, you can see an interface is shown as in Figure 4-44.

Here you can set the following items:

- Channel: Select the current camera channel.
- PTZ type: There are two types: local/remote. Please select local mode if you are connect RS485 cable to connect to the Speed dome (PTZ). Please select remote mode if you are connecting to the network PTZ camera.
- Protocol: Select corresponding PTZ protocol(such as PELCOD)
- Address: Default address is 1.
- Baud rate: Select corresponding baud rate. Default value is 9600.
- Data bit: Select corresponding data bits. Default value is 8.
- Stop bit: Select corresponding stop bits. Default value is 1.
- Parity: There are three options: odd/even/none. Default setup is none.



Figure 4-44

If you are connecting to network PTZ, the PTZ type shall be remote. See Figure 4-45.

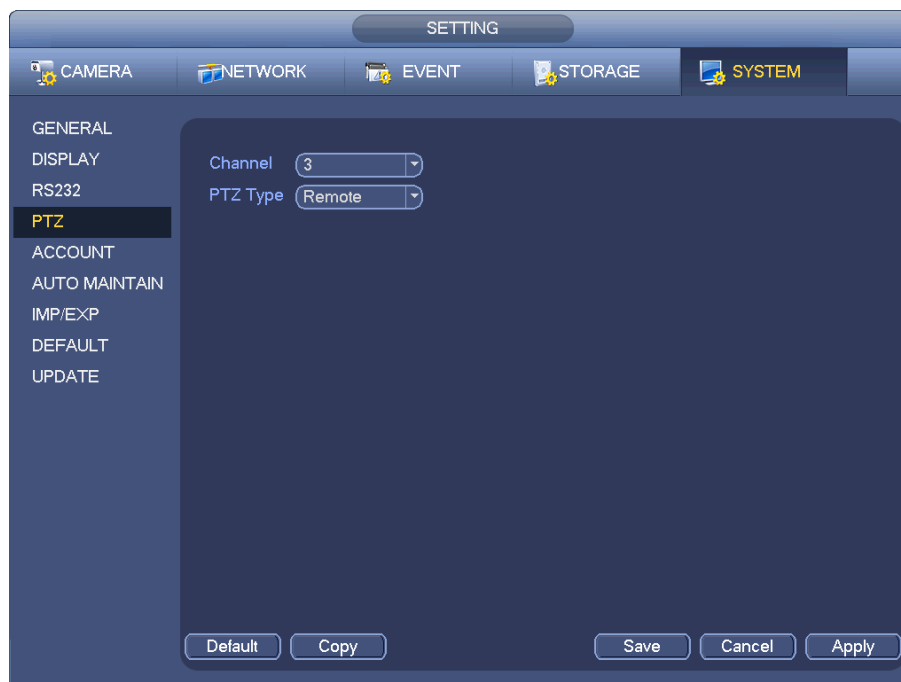

Figure 4-45

4.9.2 PTZ Control

After completing all the setting please click save button. Right click mouse (click “Fn” Button in the front panel or click “Fn” key in the remote control). The interface is shown as in Figure 4-46. Please note you can only go to the PTZ control interface when you are in 1-window display mode.



Figure 4-46



The PTZ setup is shown as in See Figure 4-47.

Please note the commend name is grey once device does not support this function.

The PTZ operation is only valid in one-window mode.

Here you can control PTZ direction, speed, zoom, focus, iris, preset, tour, scan, pattern aux function, light and wiper, rotation and etc.

Speed is to control PTZ movement speed. The value ranges from 1 to 8. The speed 8 is faster than speed 1. You can use the remote control to click the small keyboard to set.

You can click  and  of the zoom, focus and iris to zoom in/out, definition and brightness.

The PTZ rotation supports 8 directions. If you are using direction buttons on the front panel, there are only four directions: up/down/left/right.

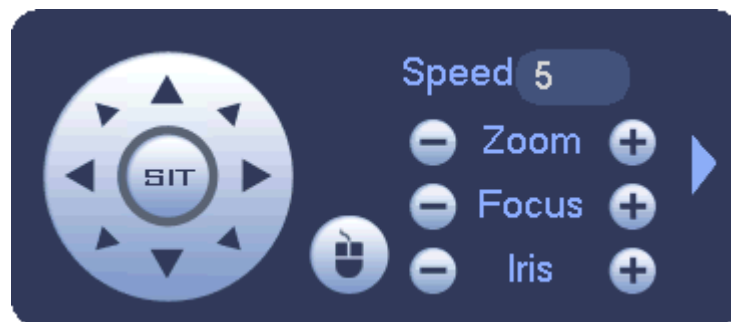

Figure 4-47

In the middle of the eight direction arrows, there is a 3D intelligent positioning key. See Figure 4-48. Please make sure your protocol supports this function and you need to use mouse to control.

Click this key, system goes back to the single screen mode. Drag the mouse in the screen to adjust section size. The dragged zone supports 4X to 16X speeds. It can realize PTZ automatically. The smaller

zone you dragged, the higher the speed.



Figure 4-48

Name	Function key	function	Shortcut key	Function key	function	Shortcut key
Zoom		Near			Far	
Focus		Near			Far	
Iris		close			Open	

In Figure 4-47, click to open the menu, you can set preset, tour, pattern, scan and etc. See Figure 4-49.

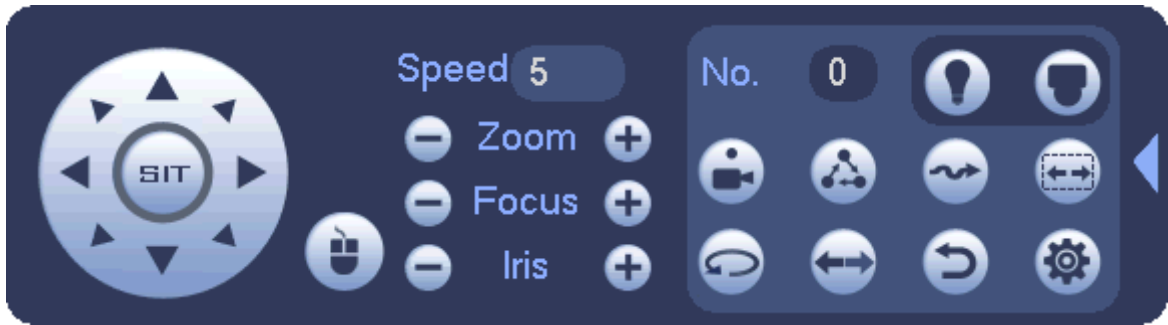

Figure 4-49

Please refer to the following sheet for detailed information.

Please note the above interface may vary due to different protocols. The button is grey and can not be selected once the current function is null.

Right click mouse or click the ESC button at the front panel to go back to the Figure 4-47.

Icon	Function	Icon	Function
	Preset		Flip
	Tour		Reset
	Pattern		Aux
	Scan		Aux on-off button
	Rotate		Go to menu

4.9.2.1 PTZ Function Setup



Click , you can go to the following interface to set preset, tour, pattern, and scan. See Figure 4-50.



Figure 4-50

Preset Setup

In Figure 4-50, click preset button and use eight direction arrows to adjust camera to the proper position. The interface is shown as in Figure 4-51.

Click Set button and then input preset number.

Click Set button to save current preset.



Figure 4-51

Tour Setup

In Figure 4-50, click tour button.

Input tour value and preset No. Click Add preset button to add current preset to the tour. See Figure 4-52.

Tips

Repeat the above steps to add more presets to the tour. Click Del preset button to remove it from the tour. Please note some protocols do not support delete preset function.



Figure 4-52

Pattern Setup

In Figure 4-50, click Pattern button and input pattern number.

Click Begin button to start direction operation. Or you can go back to Figure 4-47 to operate zoom/focus/iris/direction operation.

In Figure 4-50, click End button.



Figure 4-53

Scan Setup

In Figure 4-50, click Scan button.

Use direction buttons to set camera left limit and then click Left button.



Use direction buttons to set camera right limit and then click Right button. Now the scan setup process is complete.





Figure 4-54

4.9.2.2 Call PTZ Function

Call Preset

In Figure 4-49, input preset value and then click  to call a preset. Click  again to stop call.

Call Pattern

In Figure 4-49, input pattern value and then click  to call a pattern. Click  again to stop call.

Call Tour

In Figure 4-49, input tour value and then click  to call a tour. Click again  to stop call.

Call Scan

In Figure 4-49, input Scan value and then click  to call a tour. Click again  to stop call.

Rotate

In Figure 4-49, click  to enable the camera to rotate.

System supports preset, tour, pattern, scan, rotate, light and etc function.

Note:

- Preset, tour and pattern all need the value to be the control parameters. You can define it as you require.
- You need to refer to your camera user's manual for Aux definition. In some cases, it can be used for special process.

Aux

Click , system goes to the following interface. The options here are defined by the protocol. The aux number is corresponding to the aux on-off button of the decoder. See Figure 4-55.

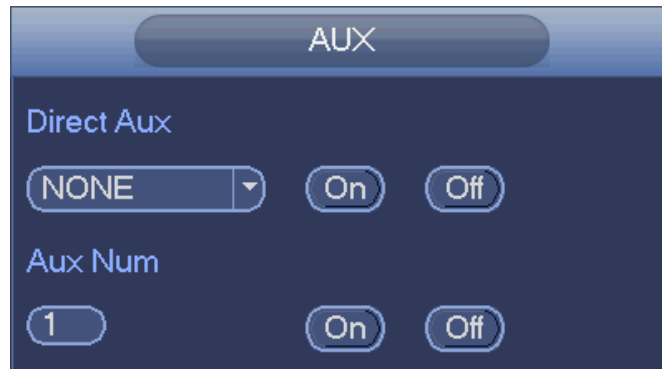

Figure 4-55

4.10 Record and Snapshot

The record/snapshot priority is: Alarm->Motion detect->Schedule.

4.10.1 Encode

4.10.1.1 Encode

Encode setting is to set IPC encode mode, resolution, bit stream type and etc

From Main menu->Setting->System->Encode, you can see the following interface. See Figure 4-56.

- Channel: Select the channel you want.
- Type: Please select from the dropdown list. There are three options: regular/motion detect/alarm. You can set the various encode parameters for different record types.
- Compression: System supports H.264, MPEG4, MJPEG and etc.
- Resolution: The mainstream resolution type is IPC's encoding config. Generally there is D1/720P/1080P. For NVR42-4K, NVR42-8P-4K series product, the main stream supports 2048 × 1536 (3M), 1920 × 1080 (1080P), 1280 × 1024 (S × GA), 1280 × 960 (1.3M), 1280 × 720 (720P), 704 × 576 (D1) and the sub stream supports 704 × 576 (D1), 352 × 288 (CIF).
- Frame rate: It ranges from 1f/s to 25f/s in NTSC mode and 1f/s to 30f/s in PAL mode.
- Bit rate type: System supports two types: CBR and VBR. In VBR mode, you can set video quality.
- Quality: There are six levels ranging from 1 to 6. The sixth level has the highest image quality.
- Video/audio: You can enable or disable the video/audio. Please note, once you enable audio function for one channel, system may enable audio function of the rest channels by default.
- Copy: After you complete the setup, you can click Copy button to copy current setup to other channel(s). You can see an interface is shown as in Figure 4-59. You can see current channel number is grey. Please check the number to select the channel or you can check the box ALL. Please click the OK button in Figure 4-59 and Figure 4-57 respectively to complete the setup. Please note, once you check the All box, you set same encode setup for all channels. Audio/video enable box, overlay button and the copy button is shield.

Please highlight icon  to select the corresponding function.



Figure 4-56

4.10.1.2 Overlay

Click overlay button, you can see an interface is shown in Figure 4-57.

- Cover area: Here is for you to cover area section. You can drag you mouse to set proper section size. In one channel video, system max supports 4 zones in one channel. You can set with Fn button or direction buttons.
- Preview/monitor: The cover area has two types. Preview and Monitor. Preview means the privacy mask zone can not be viewed by user when system is in preview status. Monitor means the privacy mask zone can not be view by the user when system is in monitor status.
- Time display: You can select system displays time or not when you playback. Please click set button and then drag the title to the corresponding position in the screen.
- Channel display: You can select system displays channel number or not when you playback. Please click set button and then drag the title to the corresponding position in the screen.



Figure 4-57

4.10.1.3 Snapshot

Here you can set snapshot mode, picture size, quality and frequency. See Figure 4-58.

- Snapshot mode: There are two modes: regular and trigger. If you set regular mode, you need to set snapshot frequency. If you set trigger snapshot, you need to set snapshot activation operation.
- Image size: Here you can set snapshot picture size.
- Image quality: Here you can set snapshot quality. The value ranges from 1 to 6.
- Interval: It is for you to set timing (schedule) snapshot interval.



Figure 4-58

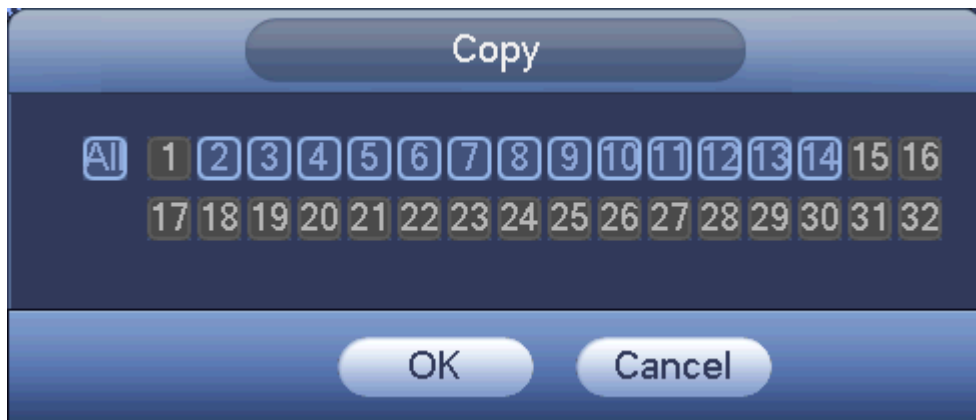

Figure 4-59

4.10.2 Schedule

The record type priority is: Alarm>Motion detect>Regular.

4.10.2.1 Schedule Record

Set record time, record plan and etc. Please note system is in 24-hour record by default after its first boot up.

In the main menu, from Main menu->Setting->Storage->Schedule, you can go to schedule menu. See Figure 4-63. There are total six periods.

- Channel: Please select the channel number first. You can select “all” if you want to set for the whole channels.

✧ : Sync connection icon. Select icon  of several dates, all checked items can be edited or together. Now the icon is shown as .

✧ : Click it to delete a record type from one period.

- Record Type: Please check the box to select corresponding record type. There are four types: Regular/MD (motion detect)/Alarm/MD&Alarm.
- Week day: There are eight options: ranges from Saturday to Sunday and all.
- Holiday: It is to set holiday setup. Please note you need to go to the General interface (Main Menu->Setting->System->General) to add holiday first. Otherwise you can not see this item.
- Pre-record: System can pre-record the video before the event occurs into the file. The value ranges from 1 to 30 seconds depending on the bit stream.
- Redundancy: System supports redundancy backup function. It allows you backup recorded file in two disks. You can highlight Redundancy button to activate this function. Please note, before enable this function, please set at least one HDD as redundant. (Main menu->Setting->Storage->HDD Manager). **Please note this function is null if there is only one HDD.**
- ANR: It is to save video to the SD card of the network camera in case the network connection fails. The value ranges from 0s~43200s. After the network connection resumed, the system can get the video from the SD card and there is no risk of record loss.

● Period setup: Click button  after one date or a holiday, you can see an interface shown as in Figure 4-64. There are four record types: regular, motion detection (MD), Alarm, MD & alarm.

Please following the steps listed below to draw the period manually.

- Select a channel you want to set. See Figure 4-60.



Figure 4-60

- Set record type. See Figure 4-61.



Figure 4-61

- Please draw manually to set record period. There are six periods in one day. See Figure 4-62.



Figure 4-62

Please check the box to select the corresponding function. After completing all the setups please click save button, system goes back to the previous menu.

There are color bars for your reference. Green color stands for regular recording, yellow color stands for motion detection and red color stands for alarm recording. The white means the MD and alarm record is valid. Once you have set to record when the MD and alarm occurs, system will not record neither motion detect occurs nor the alarm occurs.

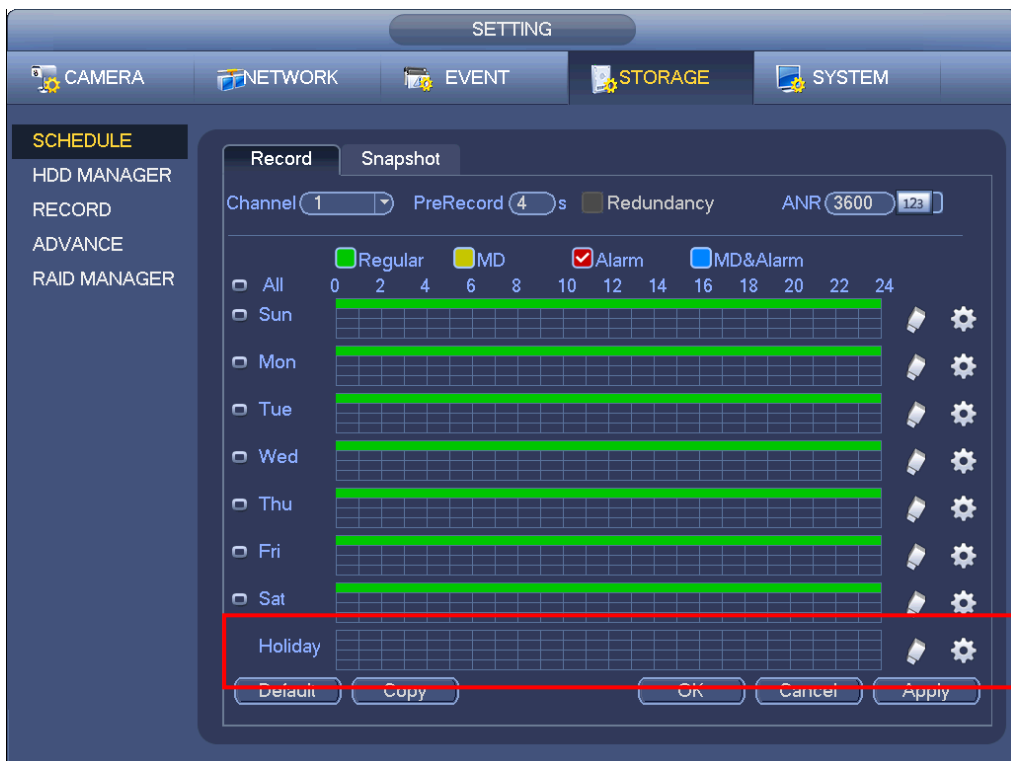

Figure 4-63



Figure 4-64

Quick Setup

Copy function allows you to copy one channel setup to another. After setting in channel 1, click Copy button, you can go to interface Figure 4-65. You can see current channel name is grey such as channel 1. Now you can select the channel you want to paste such as channel 5/6/7. If you want to save current setup of channel 1 to all channels, you can click the first box "ALL". Click the OK button to save current copy setup. Click the OK button in the Encode interface, the copy function succeeded.

Please note, if you select ALL in Figure 4-65, the record setup of all channels are the same and the Copy button becomes hidden.

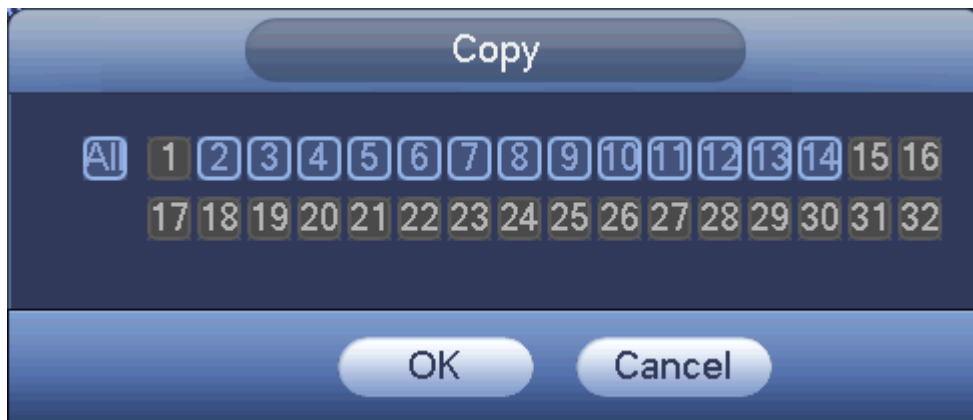

Figure 4-65

Click OK button to save current setup.

4.10.2.2 Schedule Snapshot

From Main menu->Setting->Storage->Record or on the preview interface, right click mouse and then select record item, you can see Figure 4-66.

Select snapshot channel and enable snapshot function. Click Save button.

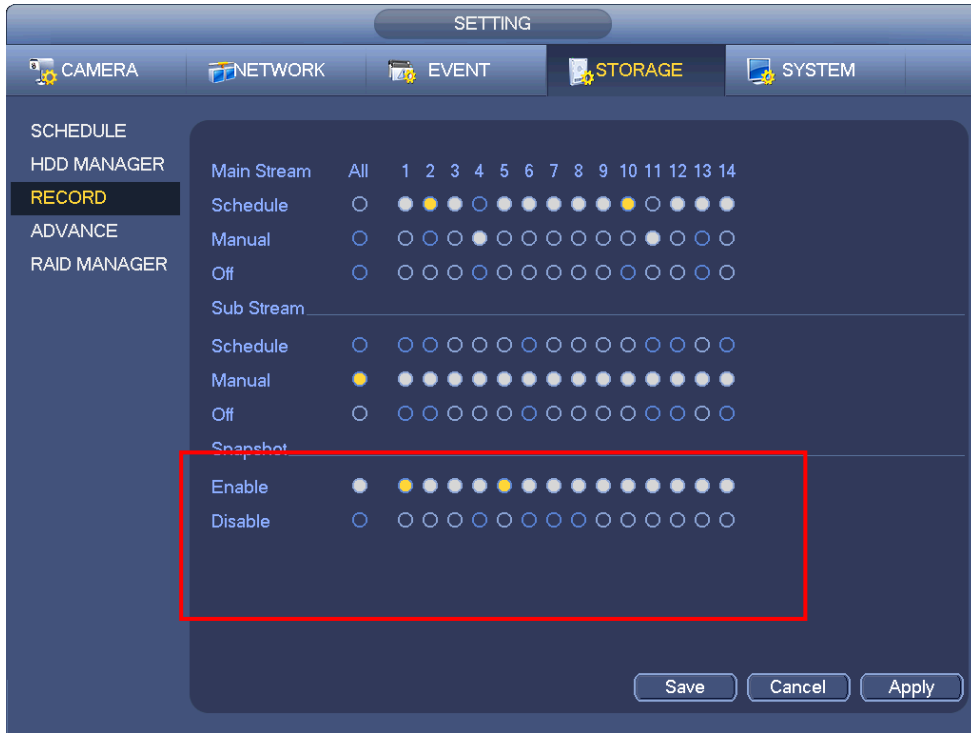

Figure 4-66

From Main menu->Setting->Camera->Encode->Snapshot, you can go to snapshot interface. See Figure 4-67.

Select the snapshot channel from the dropdown list and then select snapshot mode as Timing (Schedule) from the dropdown list and then set picture size, quality and snapshot frequency.



Figure 4-67

In the main menu, from Main menu->Setting->Storage->Schedule, you can go to schedule menu. See Figure 4-63. Here you can set snapshot period. There are total six periods in one day. Please refer to chapter 4.10.2.1 for detailed setup information. The setup steps are general the same.



Figure 4-68

Note

- Please note the trigger snapshot has the higher priority than regular snapshot. If you have enabled these two types at the same time, system can activate the trigger snapshot when an alarm occurs, and otherwise system just operates the regular snapshot.
- Only the trigger snapshot supports this function. The regular snapshot function can not send out picture via the email. But you can upload the picture to a FTP.





4.10.3 Motion detect record/snapshot

4.10.3.1 Motion detect record

- a) From Main menu->Setting->Event->Detect, you can go to the following interface. See Figure 4-69.



Figure 4-69

- b) Select motion detect from the event type dropdown list. Select a channel from the dropdown list and then check the enable button to enable motion detect function.
- c) Click Region Select button to set motion detect zone. There are 396(PAL)/330(NTSC) small zones. The green zone is current cursor position. Grey zone is the motion detection zone. Black zone is the disarmed zone. You can click Fn button to switch between the arm mode and disarm mode. In arm mode, you can click the direction buttons to move the green rectangle to set the motion detection zone. After you completed the setup, please click ENTER button to exit current setup. Do remember click save button to save current setup. If you click ESC button to exit the region setup interface system will not save your zone setup.
- d) Period: Click set button, you can see an interface is shown as in Figure 4-92. Here you can set motion detect period. System only enables motion detect operation in the specified periods. It is not for video loss or the tampering. There are two ways for you to set periods. Please note system only supports 6 periods in one day.
 - ✧ In Figure 4-92, Select icon  of several dates, all checked items can be edited together. Now the icon is shown as . Click  to delete a record type from one period.
 - ✧ In Figure 4-92. Click button  after one date or a holiday, you can see an interface shown as in Figure 4-93. There are four record types: regular, motion detection (MD), Alarm, MD & alarm.
- e) Set sensitivity. Please note the sixth level has the highest sensitivity.
- f) Click Save button to complete motion detect setup.
- g) From Main menu->Setting->Storage->-Schedule. See Figure 4-63
- h) Set motion detect record channel, period and the record type shall be motion detect (MD). Please refer to chapter 4.10.2.

- i) Click Copy button to copy current setup to other channel(s).
- j) Click OK button to complete motion detect record setup.

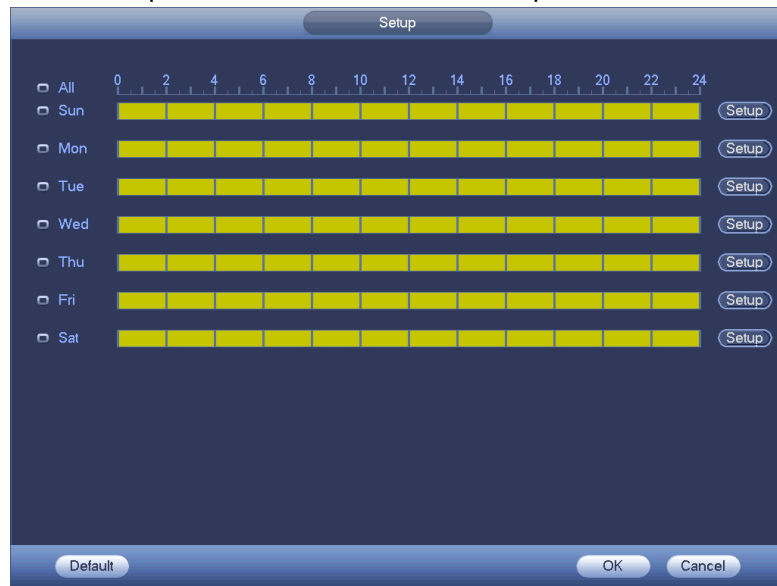

Figure 4-70



Figure 4-71

4.10.3.2 Motion Detect Snapshot

- a) From Main menu->Setting->Camera->Encode->Snapshot, you can go to snapshot interface. See Figure 4-72.
- b) In Figure 4-72, select trigger snapshot from the dropdown list and then set picture size, quality and snapshot frequency. Click OK button to save current setup.
- c) From Main menu->Setting->Event->Detect, here you can select motion detect type, motion detect channel and then check the enable box. Please refer to chapter 4.10.3.1.
- d) Click OK button to complete motion detect setup.



Figure 4-72

4.10.4 Alarm Record/Snapshot

4.10.4.1 Alarm Record

- a) Before you set alarm setup information, please go to chapter 2.3 to connect alarm input and alarm output cable (such as light, siren and etc).
- b) The record priority is: Alarm>Motion detect>Regular.

In the main menu, from Setting->Event-> Alarm, you can see alarm setup interface. See Figure 4-73.

- Alarm in: Here is for you to select channel number.
 - Event type: There are four types. Local input/network input/IPC external/IPC offline alarm.
 - ✧ Local input alarm: The alarm signal system detects from the alarm input port.
 - ✧ Network input alarm: It is the alarm signal from the network.
 - ✧ IPC external alarm: It is the on-off alarm signal from the front-end device and can activate the local NVR.
 - ✧ IPC offline alarm: Once you select this item, system can generate an alarm when the front-end IPC disconnects with the local NVR. The alarm can activate record, PTZ, snapshot and etc. The alarm can last until the IPC and the NVR connection resumes.
 - Enable: Please you need to highlight this button to enable current function.
 - Type: normal open or normal close.
- c) Click Save button to complete alarm setup interface.

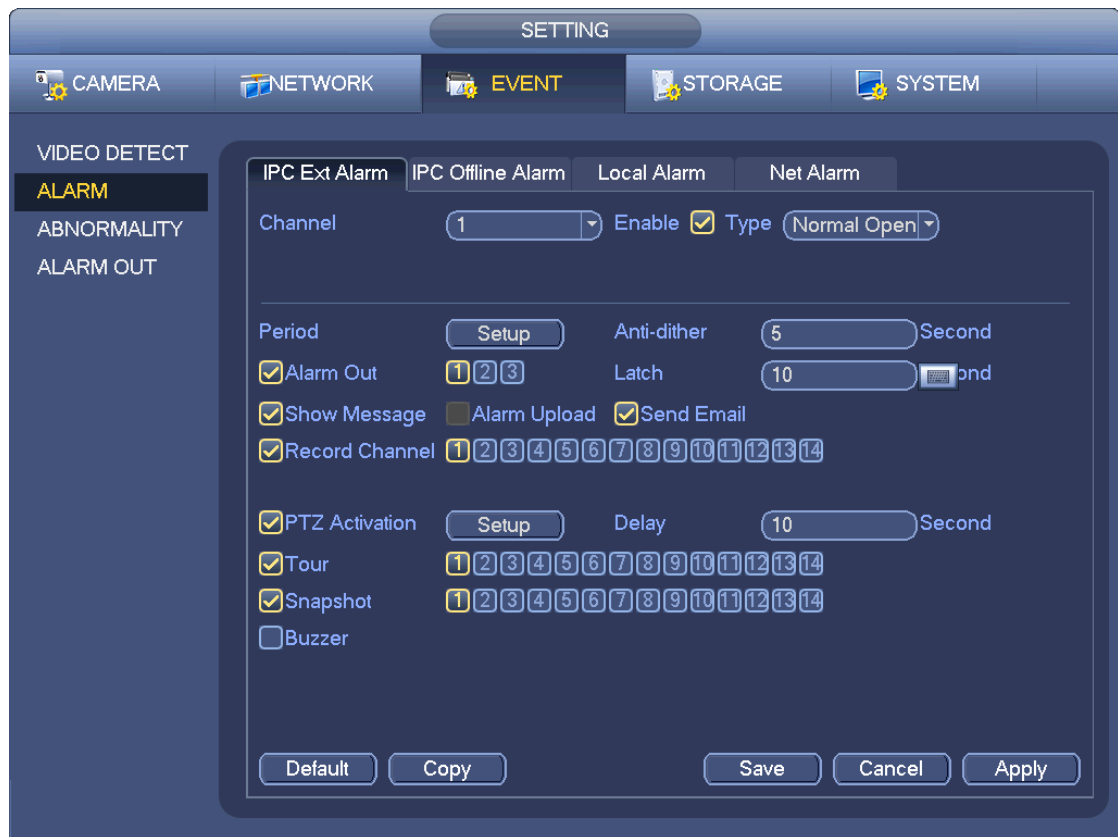

Figure 4-73

- d) From Main menu->Setting->Storage->Schedule, you can go to Figure 4-63.
- e) Select alarm channel, period and the record type shall be alarm. Please refer to chapter 4.10.2.
- f) Click Copy button to copy current setup to other channel(s).
- g) Click OK button to save alarm record information.

4.10.4.2 Alarm Snapshot

- a) Please refer to Step a) to step c) of chapter 4.10.3.2 to enable timing snapshot.
- b) From Main menu->Setting->Storage->schedule, you can go to Figure 4-74 to enable snapshot function.
- c) From Main menu->Setting->Event->Alarm, you can go to Figure 4-73 to set alarm parameter and enable snapshot function.
- d) Click Save button to save alarm snapshot setup.



Figure 4-74

4.10.5 Manual Record/Snapshot

You need to have proper rights to implement the following operations. Please make sure the HDD has been properly installed.

4.10.5.1 Manual Record

- a) Right click mouse and select manual record or in the main menu, from Setting->Storage->Manual Record. Manual record menu is shown as in Figure 4-75.

Tips

You can click Rec button on the front panel (if possible) to go to the Manual Record interface.



Figure 4-75

b) Check the box here to select manual record channel(s). You can see the corresponding indicator light on the front panel is on.

- Channel: It is to display device all channels.
- Manual: It has the highest priority. Enable corresponding channel to record no matter what period applied in the record setup. Now system is record general file.
- Auto: System enables auto record function as you set in chapter 4.10.2 schedule interface (General/Motion detect/Alarm)
- Stop: Stop current channel record/Snapshot no matter what period applied in the record setup.
- All: Check the All box to select all channels.

c) Click OK button to complete manual record setup.

4.10.5.2 Manual Snapshot

Click  button at the preview control bar, you can snapshot 1-5 picture(s). From main menu->Setting->Camera->Encode->Snapshot, you can set snapshot times. You can go to chapter 4.11 to view snapshot picture.

4.10.6 Holiday Record/Snapshot

It is for you to set holiday record or snapshot plan. Please note the holiday record/snapshot setup has the higher priority than the ordinary date record/snapshot setup.

4.10.6.1 Holiday Record

a) From Mani menu->Setting->System->General, you can go to the following interface. See Figure 4-76.

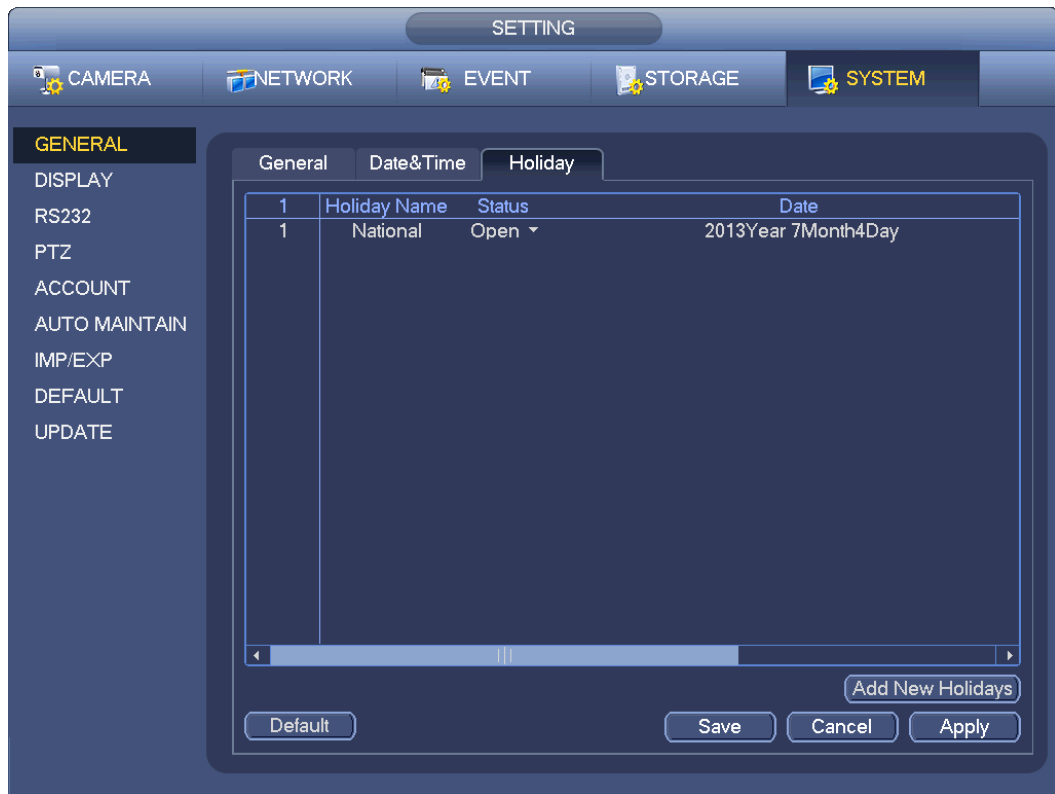

Figure 4-76

- b) Click Add new holiday button, you can see an interface shown as in Figure 4-77. Here you can set holiday date name, repeat mode, start time/end time and etc.



Figure 4-77

- c) Click Add button to complete holiday setup. Now you can enable holiday setup and then click Apply button.
- d) From Main menu->setting->Storage->schedule, you can go to schedule interface. See Figure

4-78. Now you can set period and record type of holiday time. Please refer to chapter 4.10.2.1 for detailed setup information.

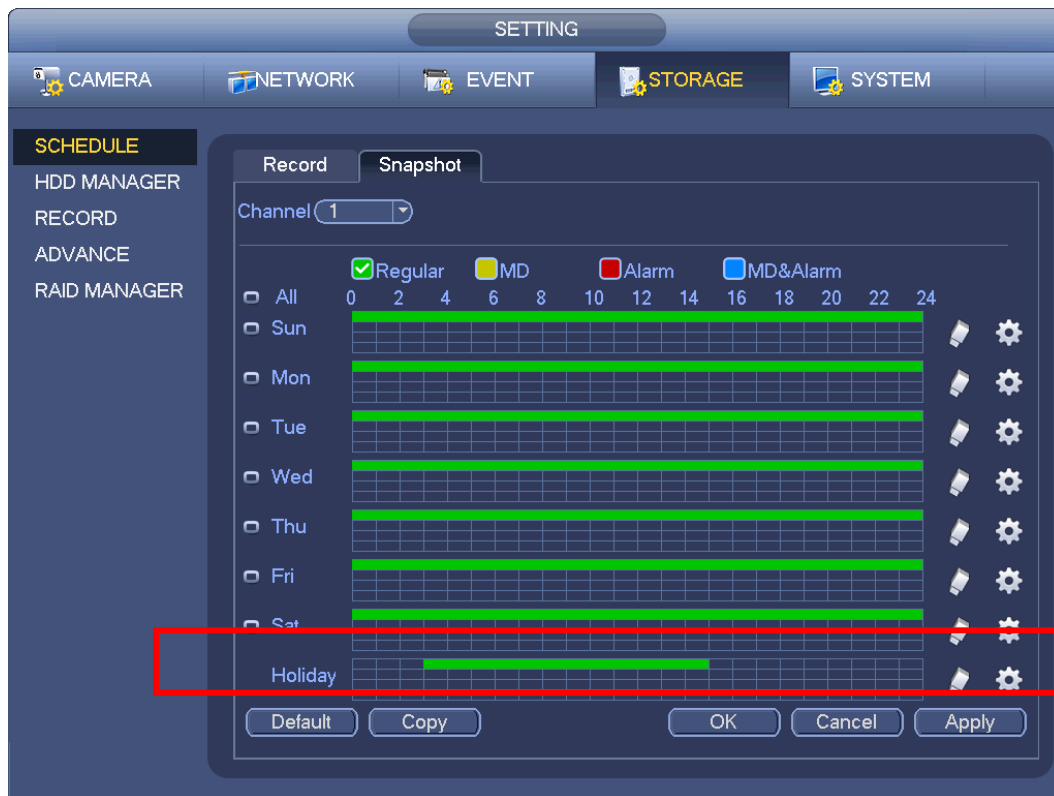

Figure 4-78

e) Click OK button to set holiday record setup.

4.10.6.2 Holiday Snapshot

Set Holiday date first. Please refer to step a) to step c) of chapter 4.10.6.1.

From Main menu->Setting->Storage->Schedule, you can go to schedule interface. See Figure 4-78. Click Holiday item to set snapshot period.

Set holiday snapshot type (Trigger/Regular). Please refer to chapter 4.10.2.2 or chapter 4.10.3.2.

4.10.7 Other Record/Snapshot

Motion detect&Alarm record or snapshot, please refer to chapter 4.10.4.

Video loss or tampering record or snapshot function, please refer to chapter 4.10.3.

4.11 Playback and Search

4.11.1 Real-time Playback

Please refer to chapter 4.7.2 for real-time playback information.

4.11.2 Search Interface

From Main menu->Search, or on the preview interface right click mouse and then select search item, you can go to the following interface. See Figure 4-79.

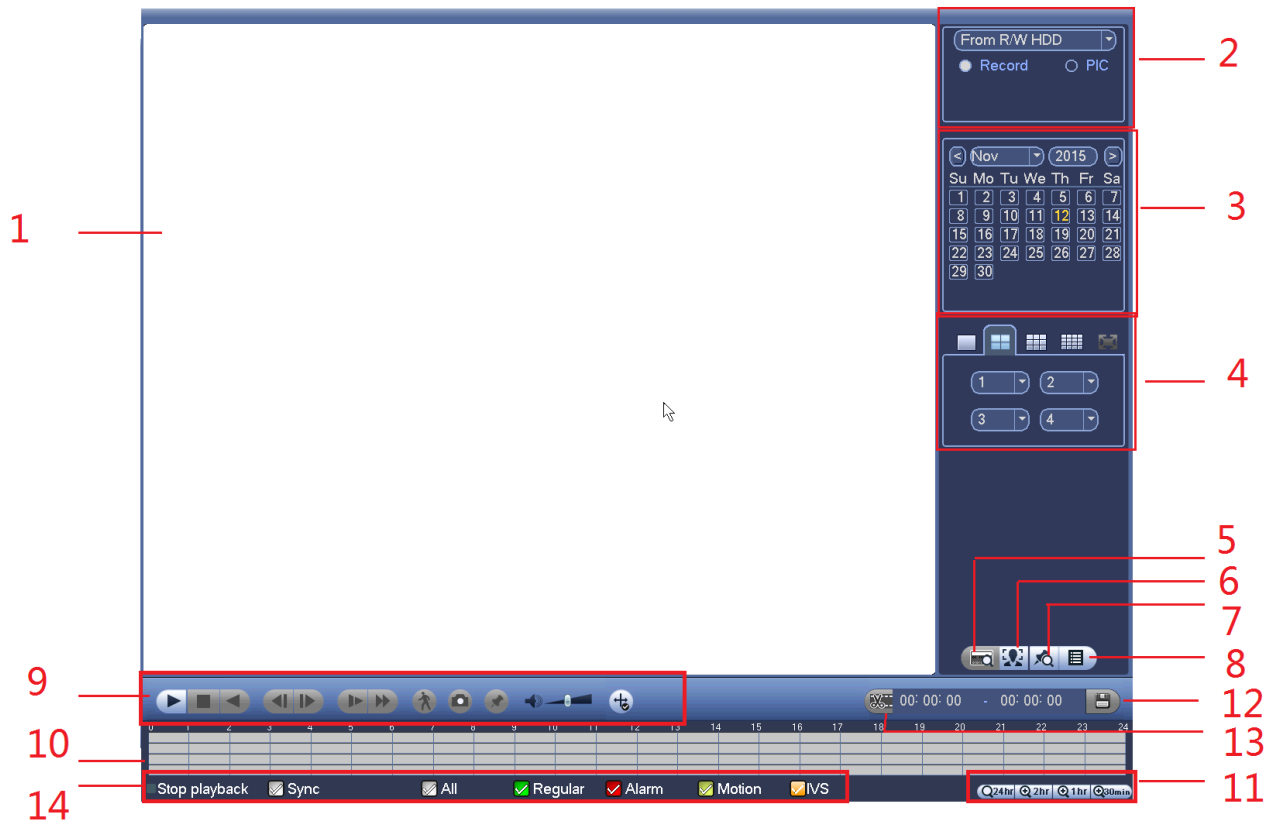
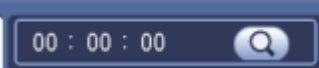



































Figure 4-79

Please refer to the following sheet for more information.

SN	Name	Function
1	Display window	<ul style="list-style-type: none"> ● Here is to display the searched picture or file. ● Support 1/4/9/16-window playback. (It depends on the product channel amount).
2	Search type	<ul style="list-style-type: none"> ● Here you can select to search the picture or the recorded file. ● You can select to play from the read-write HDD, from peripheral device or from redundancy HDD. ● Before you select to play from the peripheral device, please connect the corresponding peripheral device. You can view all record files of the root directory of the peripheral device. Click the Browse button; you can select the file you want to play. <p>Important</p> <ul style="list-style-type: none"> ● Redundancy HDD does not support picture backup function, but it supports picture playback function. You can select to play from redundancy HDD if there are pictures on the redundancy HDD.
3	Calendar	<ul style="list-style-type: none"> ● The blue highlighted date means there is picture or file. Otherwise, there is no picture or file. ● In any play mode, click the date you want to see, you can see the corresponding record file trace in the time bar.
4	Playback mode and	<ul style="list-style-type: none"> ● Playback mode: 1/4/9/16. (It may vary due to different series.) ◇ In 1-window playback mode: you can select 1-X channels (X depends on the product channel amount).

	channel selection pane.	<ul style="list-style-type: none"> ✧ In 4-window playback mode: you can select 4 channels according to your requirement. ✧ In 9-window playback mode, you can switch between 1-8, 9-16 and etc channels. ✧ In 16-window playback mode, you can switch between 1-16, 17-32 and etc channels. ● The time bar will change once you modify the playback mode or the channel option. 								
5	Card number search	The card number search interface is shown as below. Here you can view card number/field setup bar. You can implement advanced search. Current series product supports this function.								
6	Face list	You can search when it is in 1-channel playback mode. Click it, system can filter all human faces and generate human face list. Double click the file; system begins playback the record or image of the corresponding human face.								
7	Mark file list button	Click it to go to mark file list interface. You can view all mark information of current channel by time. Please refer to chapter 4.11.2.3 for detailed information. Please note only the product of this icon supports mark function.								
8	File list switch button	<ul style="list-style-type: none"> ● Double click it, you can view the picture/record file list of current day. ● The file list is to display the first channel of the record file. ● The system can display max 128 files in one time. Use the ◀ and ▶ or the mouse to view the file. Select one item, and then double click the mouse or click the ENTER button to playback. ● You can input the period in the following interface to begin accurate search. ● File type: R—regular record; A—external alarm record; M—Motion detect record.  <ul style="list-style-type: none"> ● Lock file. Click the file you want to lock and click the button  to lock. The file you locked will not be overwritten. ● Search locked file: Click the button  to view the locked file. 								
9	Playback control pane.	<table border="1"> <tr> <td></td> <td> Play/Pause  There are three ways for you to begin playback. <ul style="list-style-type: none"> ● The play button ● Double click the valid period of the time bar. ● Double click the item in the file list. In slow play mode, click it to switch between play/pause. </td> </tr> <tr> <td></td> <td>Stop</td> </tr> <tr> <td></td> <td> Backward play In normal play mode, left click the button, the file begins backward play. Click it again to pause current play. In backward play mode, click ▶/ to restore normal play. </td> </tr> <tr> <td></td> <td> In playback mode, click it to play the next or the previous section. You can click continuously when you are watching the files from the same channel. In normal play mode, when you pause current play, you can click ◀ and </td> </tr> </table>		Play/Pause  There are three ways for you to begin playback. <ul style="list-style-type: none"> ● The play button ● Double click the valid period of the time bar. ● Double click the item in the file list. In slow play mode, click it to switch between play/pause.		Stop		Backward play In normal play mode, left click the button, the file begins backward play. Click it again to pause current play. In backward play mode, click ▶/ to restore normal play.		In playback mode, click it to play the next or the previous section. You can click continuously when you are watching the files from the same channel. In normal play mode, when you pause current play, you can click ◀ and
	Play/Pause  There are three ways for you to begin playback. <ul style="list-style-type: none"> ● The play button ● Double click the valid period of the time bar. ● Double click the item in the file list. In slow play mode, click it to switch between play/pause.									
	Stop									
	Backward play In normal play mode, left click the button, the file begins backward play. Click it again to pause current play. In backward play mode, click ▶/ to restore normal play.									
	In playback mode, click it to play the next or the previous section. You can click continuously when you are watching the files from the same channel. In normal play mode, when you pause current play, you can click ◀ and									

		<p> to begin frame by frame playback. In frame by frame playback mode, click  to restore normal playback.</p>
		<p> Slow play In playback mode, click it to realize various slow play modes such as slow play 1, slow play 2, and etc.</p>
		<p> Fast forward In playback mode, click to realize various fast play modes such as fast play 1, fast play 2 and etc.</p>
		Note: The actual play speed has relationship with the software version.
		<p> Smart search</p>
		<p> The volume of the playback</p>
		<p> Click the snapshot button in the full-screen mode, the system can snapshot 1 picture. System supports custom snap picture saved path. Please connect the peripheral device first, click snap button on the full-screen mode, you can select or create path. Click Start button, the snapshot picture can be saved to the specified path.</p>
		<p> Mark button. Please note this function is for some series product only. Please make sure there is a mark button in the playback control pane. You can refer to chapter 4.11.2.3 for detailed information.</p>
		<p> In 1-channel playback mode, click it to enable/disable display IVS rule information on the video.</p>
10	Time bar	<ul style="list-style-type: none"> ● It is to display the record type and its period in current search criteria. ● In 4-window playback mode, there are corresponding four time bars. In other playback mode, there is only one time bar. ● Use the mouse to click one point of the color zone in the time bar, system begins playback. ● The time bar is beginning with 0 o'clock when you are setting the configuration. The time bar zooms in the period of the current playback time when you are playing the file. ● The green color stands for the regular record file. The red color stands for the external alarm record file. The yellow stands for the motion detect record file.
11	Time bar unit	<ul style="list-style-type: none"> ● The option includes: 、、 和 . The smaller the unit, the larger the zoom rate. You can accurately set the time in the time bar to playback the record. ● The time bar is beginning with 0 o'clock when you are setting the configuration. The time bar zooms in the period of the current playback time when you are playing the file.
12	Backup	<ul style="list-style-type: none"> ● Select the file(s) you want to backup from the file list. You can check from the list. Then click the backup button, now you can see the backup menu. System

		<p>supports customized path setup. After select or create new folder, click the Start button to begin the backup operation. The record file(s) will be saved in the specified folder.</p> <ul style="list-style-type: none"> ● Check the file again you can cancel current selection. System max supports to display 32 files from one channel. ● After you clip on record file, click Backup button you can save it. ● For one device, if there is a backup in process, you can not start a new backup operation.
13	Clip	<p>It is to edit the file.</p> <ul style="list-style-type: none"> ● Please click  to play the file you want to edit. ● Select clip start time on the time bar and then Click  to start clip. ● Select clip stop time on the time bar and then click  to stop clip. ● Click , system pops up file backup dialogue box for you to save. <p>Please note:</p> <ul style="list-style-type: none"> ● Clip function is for one-channel mode/multiple-channel mode. ● System max supports 1024 files backup at the same time. ● You can not operate clip operation if there is any file has been checked in the file list.
14	Record type	In any play mode, the time bar will change once you modify the search type.
Other Functions		
15	Smart search	<ul style="list-style-type: none"> ● When system is playing, you can select a zone in the window to begin smart search. Click the motion detect button to begin play. ● Once the motion detect play has begun, click button again will terminate current motion detect file play. ● There is no motion detect zone by default. ● If you select to play other file in the file list, system switches to motion detect play of other file. ● During the motion detect play process, you can not implement operations such as change time bar, begin backward playback or frame by frame playback. ● Please refer to chapter 4.11.2.1 Smart Search for detailed operation.
16	Other channel synchronization switch to play when playback	When playing the file, click the number button, system can switch to the same period of the corresponding channel to play.

17	Digital zoom	When the system is in full-screen playback mode, left click the mouse in the screen. Drag your mouse in the screen to select a section and then left click mouse to realize digital zoom. You can right click mouse to exit.
18	Manually switch channel when playback	During the file playback process, you can switch to other channel via the dropdown list or rolling the mouse. This function is null if there is no record file or system is in smart search process.

Note:

All the operations here (such as playback speed, channel, time and progress) have relationship with hardware version. Some series NVRs do not support some functions or playback speeds.

4.11.2.1 Smart Search

During the multiple-channel playback mode, double click one channel and then click the  button, system begins smart search. System supports 396(22*18 PAL) and 330(22*15 NTSC) zones. Please left click mouse to select smart search zones. See Figure 4-80.

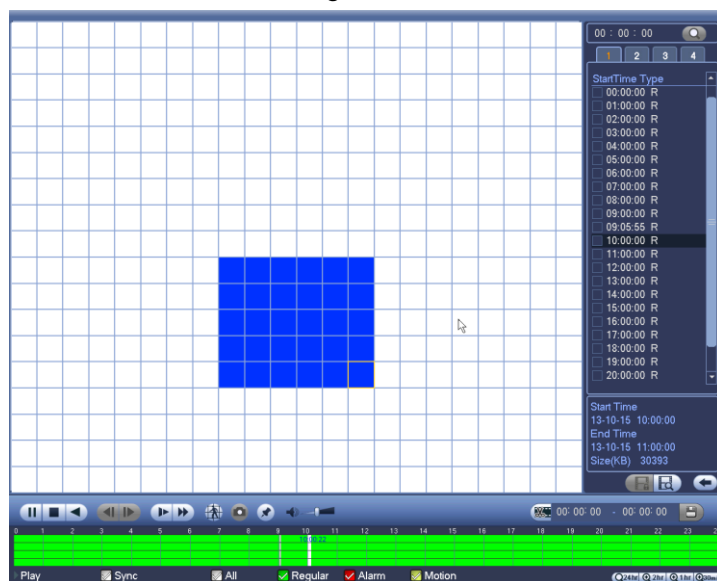



Figure 4-80

Click the , you can go to the smart search playback. Click it again, system stops smart search playback.

Important

- **System does not support motion detect zone setup during the full-screen mode.**
- **During the multiple-channel playback, system stops playback of rest channels if you implement one-channel smart search.**

4.11.2.2 Accurate playback by time

Select records from one day, click the list, you can go to the file list interface. You can input time at the top

right corner to search records by time. See image on the left side of the Figure 4-81 For example, input time 11:00.00 and then click Search button , you can view all the record files after 11:00.00 (The records includes current time.). See image on the right side of the Figure 4-81 Double click a file name to playback.

Note

- After you searched files, system implement accurate playback once you click Play for the first time.
- System does not support accurate playback for picture.
- System supports synchronization playback and non-synchronous playback. The synchronization playback supports all channels and non-synchronous playback only supports accurately playback of current select channel.



Figure 4-81

4.11.2.3 Mark Playback

Please make sure your purchased device support this function. You can use this function only if you can see the mark playback icon on the Search interface (Figure 4-79).

When you are playback record, you can mark the record when there is important information. After playback, you can use time or the mark key words to search corresponding record and then play. It is very easy for you to get the important video information.

- Add Mark

When system is playback, click Mark button , you can go to the following interface. See Figure 4-82.

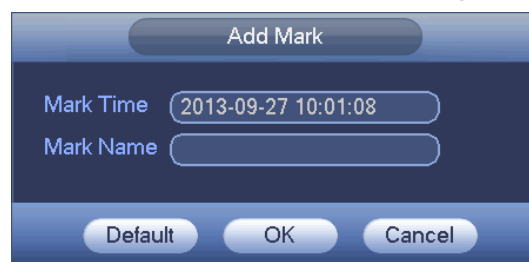



Figure 4-82

- Playback Mark

During 1-window playback mode, click mark file list button  in Figure 4-79, you can go to mark file list interface. Double click one mark file, you can begin playback from the mark time.

- Play before mark time

Here you can set to begin playback from previous N seconds of the mark time.

Note

Usually, system can playbacks previous N seconds record if there is such kind of record file. Otherwise, system playbacks from the previous X seconds when there is such as kind of record.

- Mark Manager

Click the mark manager button  on the Search interface (Figure 4-79); you can go to Mark Manager interface. See Figure 4-83. System can manage all the record mark information of current channel by default. You can view all mark information of current channel by time.

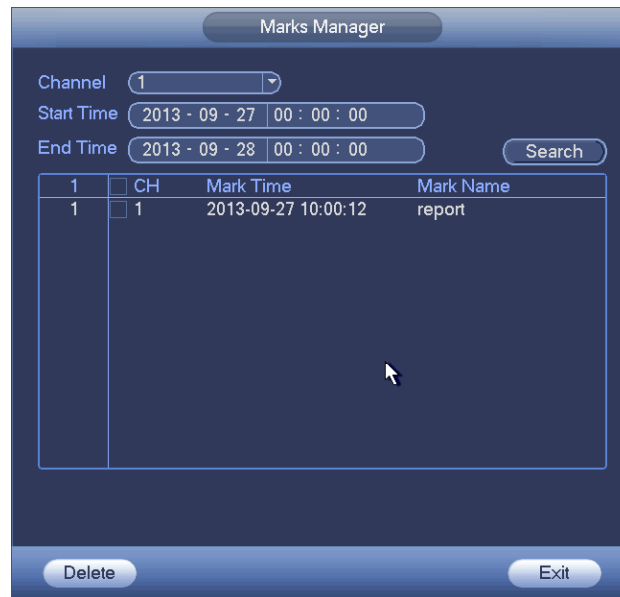

Figure 4-83

- Modify

Double click one mark information item, you can see system pops up a dialogue box for you to change mark information. You can only change mark name here.

- Delete

Here you can check the mark information item you want to delete and then click Delete button, you can remove one mark item. .

Note

- After you go to the mark management interface, system needs to pause current playback. System resume playback after you exit mark management interface.
- If the mark file you want to playback has been removed, system begin playbacking from the first file in the list.

4.11.3 Picture Playback

- a) From Main menu->Search, or on the preview interface right click mouse, you can go to Figure 4-79.
- b) At the top right pane, you can check the box to select picture and then select playback interval.
- c) Please refer to chapter 4.11.2 to select picture you want to view.

4.12 Backup

4.12.1 File Backup

In this interface, you can backup record file to the USB device.

- Connect USB burner, USB device or portable HDD and etc to the device.
- From Main menu->Backup, you can go to the Backup interface. See Figure 4-84

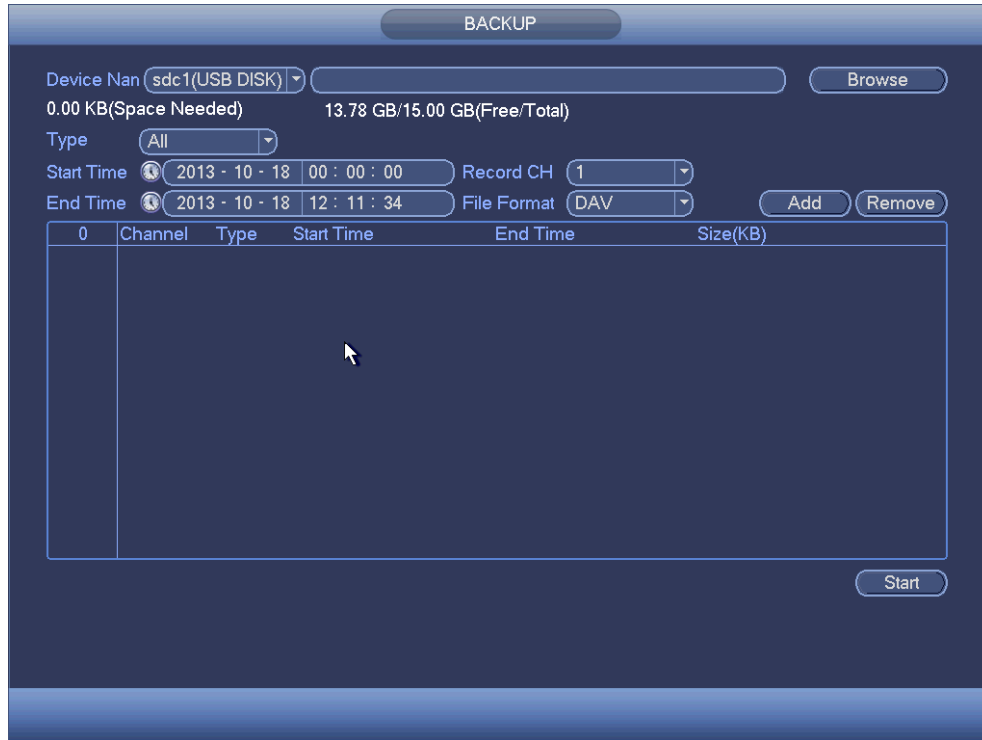

Figure 4-84

- Select backup device and then set channel, file start time and end time.
- Click add button, system begins search. All matched files are listed below. System automatically calculates the capacity needed and remained. See Figure 4-85.
- System only backup files with a \checkmark before channel name. You can use Fn or cancel button to delete \checkmark after file serial number.
- Click backup button, you can backup selected files. There is a process bar for you reference.
- When the system completes backup, you can see a dialogue box prompting successful backup.

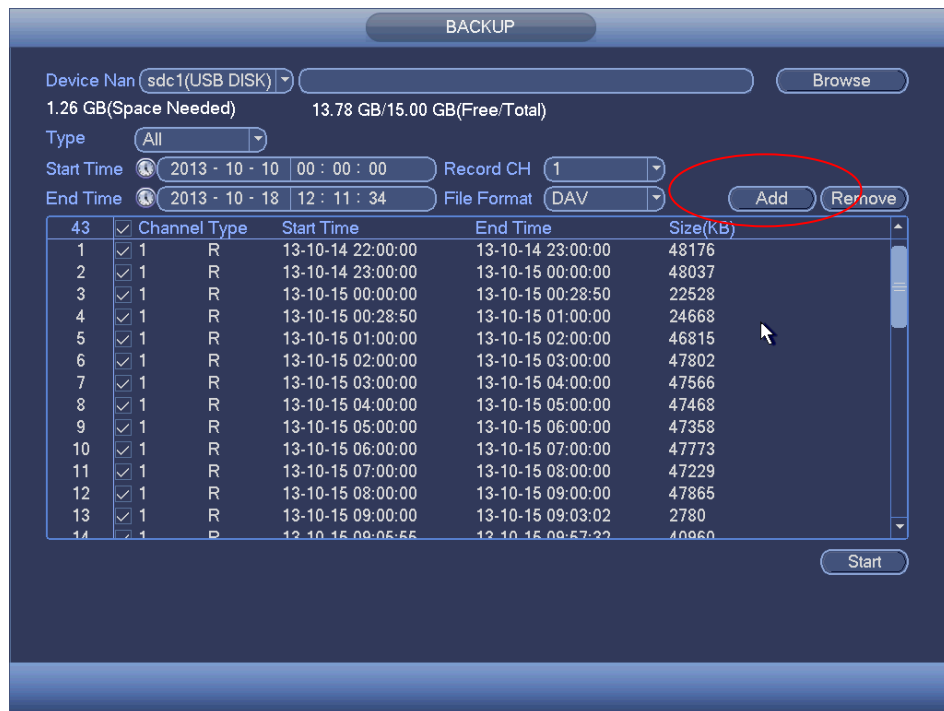

Figure 4-85

- h) Click backup button, system begins burning. At the same time, the backup button becomes stop button. You can view the remaining time and process bar at the left bottom.

Note

- During backup process, you can click ESC to exit current interface for other operation (For some series product only). The system will not terminate backup process.
- The file name format usually is: Channel number+Record type+Time. In the file name, the YDM format is Y+M+D+H+M+S. File extension name is .dav.

4.12.2 Import/Export

This function allows you to copy current system configuration to other devices. It also supports import, create new folder, and delete folder and etc function.

From Main menu->Setting->System->Import/Export, you can see the configuration file backup interface is shown as below. See Figure 4-86.



Figure 4-86

- Export: Please connect the peripheral device first and then go to the following interface. Click Export button, you can see there is a corresponding “Config_Time” folder. Double click the folder, you can view some backup files.
- Import: Here you can import the configuration files from the peripheral device to current device. You need to select a folder first. You can see a dialogue box asking you to select a folder if you are selecting a file. System pops up a dialogue box if there is no configuration file under current folder. After successfully import, system needs to reboot to activate new setup.
- Format: Click Format button, system pops up a dialogue box for you to confirm current operation. System begins format process after you click the OK button.

Note:

- System can not open config backup interface again if there is backup operation in the process.
- System refreshes device when you go to the config backup every time and set current directory as the root directory of the peripheral device.
- If you go to the configuration backup interface first and then insert the peripheral device, please click Refresh button to see the newly added device.

4.12.3 Backup Log

- a) From Main menu->Info->Log, the interface is shown as below. See Figure 4-87.



Figure 4-87

- b) Select log type and then set start time/end time, click Search button, you can see log time and event information. Click  to view detailed log information.
- c) Select log items you want to save and then click backup button, you can select a folder to save them. Click Start to backup and you can see the corresponding dialogue box after the process is finish.

4.12.4 USB Device Auto Pop-up

After you inserted the USB device, system can auto detect it and pop up the following dialogue box. It allows you to conveniently backup file, log, configuration or update system. See Figure 4-88. Please refer to chapter 4.12.1 file backup, chapter 4.12.3 backup log, chapter 4.12.2 import/export, and chapter 4.11.2 search for detailed information.



Figure 4-88

4.13 Alarm

4.13.1 Detect Alarm

In the main menu, from Setting to Detect, you can see motion detect interface. See Figure 4-89. There are three detection types: motion detection, video loss, tampering.





4.13.1.1 Motion Detect

After analysis video, system can generate a motion detect alarm when the detected moving signal reached the sensitivity you set here.

Detection menu is shown as below. See Figure 4-89.

- Event type: From the dropdown list you can select motion detection type.
- Channel: Select a channel from the dropdown list to set motion detect function.
- Enable: Check the box here to enable motion detect function.
- Region: Click select button, the interface is shown as in Figure 4-90. Here you can set motion detection zone. There are four zones for you to set. Please select a zone first and then left drag the mouse to select a zone. The corresponding color zone displays different detection zone. You can click Fn button to switch between the arm mode and disarm mode. In arm mode, you can click the direction buttons to move the green rectangle to set the motion detection zone. After you completed the setup, please click ENTER button to exit current setup. Do remember click save button to save current setup. If you click ESC button to exit the region setup interface system will not save your zone setup.
- Sensitivity: System supports 6 levels. The sixth level has the highest sensitivity.
- Anti-dither: Here you can set anti-dither time. The value ranges from 5 to 600s. The anti-dither time refers to the alarm signal lasts time. It can be seem as the alarm signal activation stays such as the buzzer, tour, PTZ activation, snapshot, channel record. The stay time here does not include the latch time. During the alarm process, the alarm signal can begin an anti-dither time if system detects the local alarm again. The screen prompt, alarm upload, email and etc will not be activated. For example, if you set the anti-dither time as 10 second, you can see the each activation may last 10s if the local alarm is activated. During the process, if system detects another local alarm signal at the fifth second, the buzzer, tour, PTZ activation, snapshot, record channel will begin another 10s while the

screen prompt, alarm upload, email will not be activated again. After 10s, if system detects another alarm signal, it can generate an alarm since the anti-dither time is out.

- Period: Click set button, you can see an interface is shown as in Figure 4-92. Here you can set motion detect period. System only enables motion detect operation in the specified periods. It is not for video loss or the tampering. There are two ways for you to set periods. Please note system only supports 6 periods in one day.
- ✧ In Figure 4-92, Select icon  of several dates, all checked items can be edited together. Now the icon is shown as . Click  to delete a record type from one period.
- ✧ In Figure 4-92. Click button  after one date or a holiday, you can see an interface shown as in Figure 4-93. There are four record types: regular, motion detection (MD), Alarm, MD & alarm.
 - Alarm output: when an alarm occurs, system enables peripheral alarm devices.
 - Latch: when motion detection complete, system auto delays detecting for a specified time. The value ranges from 1-300(Unit: second)
 - Show message: System can pop up a message to alarm you in the local host screen if you enabled this function.
 - Alarm upload: System can upload the alarm signal to the network (including alarm centre) if you enabled current function.
 - Send email: System can send out email to alert you when an alarm occurs.
 - Record channel: System auto activates motion detection channel(s) to record once an alarm occurs. Please make sure you have set MD record in Schedule interface(Main Menu->Setting->Schedule) and schedule record in manual record interface(Main Menu->Advanced->Manual Record)
 - PTZ activation: Here you can set PTZ movement when an alarm occurs. Such as go to preset, tour & pattern when there is an alarm. Click “select” button, you can see an interface is shown as in Figure 4-91.
 - Record Delay: System can delay the record for specified time after alarm ended. The value ranges from 10s to 300s.
 - Tour: Here you can enable tour function when alarm occurs. System one-window tour.
 - Snapshot: You can enable this function to snapshot image when a motion detect alarm occurs.
 - Video matrix Check the box here to enable this function. When an alarm occurs, SPOT OUT port displays device video output. It displays video (1-window tour) from alarm activation channel you select at the Record channel item.
 - Buzzer: Highlight the icon to enable this function. The buzzer beeps when alarm occurs.

Please highlight icon  to select the corresponding function. After all the setups please click save button, system goes back to the previous menu.

Note:

In motion detection mode, you can not use copy/paste to set channel setup since the video in each channel may not be the same.

In Figure 4-90, you can left click mouse and then drag it to set a region for motion detection. Click Fn to switch between arm/withdraw motion detection. After setting, click enter button to exit.



Figure 4-89

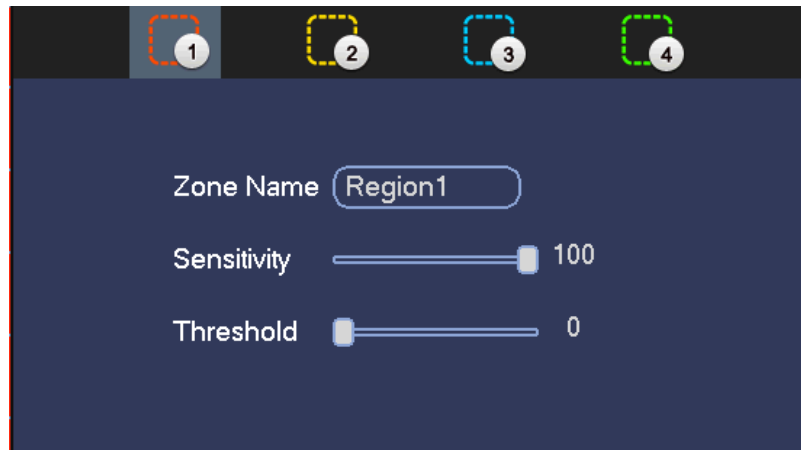

Figure 4-90



Figure 4-91



Figure 4-92



Figure 4-93

Motion detect here only has relationship with the sensitivity and region setup. It has no relationship with other setups.

4.13.1.2 Tampering

When someone viciously masks the lens, or the output video is in one-color due to the environments light change, the system can alert you to guarantee video continuity. Tampering interface is shown as in Figure 4-94. You can enable “Alarm output “or “Show message” function when tampering alarm occurs.

- Sensitivity: The value ranges from 1 to 6. It mainly concerns the brightness. The level 6 has the higher sensitivity than level 1. The default setup is 3.

Tips:

You can enable preset/tour/pattern activation operation when video loss occurs.

Please refer to chapter 4.13.1.1 motion detection for detailed information.

Note:

- In Detect interface, copy/paste function is only valid for the same type, which means you can not copy a channel setup in video loss mode to tampering mode.
- About Default function. Since detection channel and detection type may not be the same, system can only restore default setup of current detect type. For example, if you click Default button at the tampering interface, you can only restore default tampering setup. It is null for other detect types.
- System only enables tampering function during the period you set here. It is null for motion detect or video loss type.

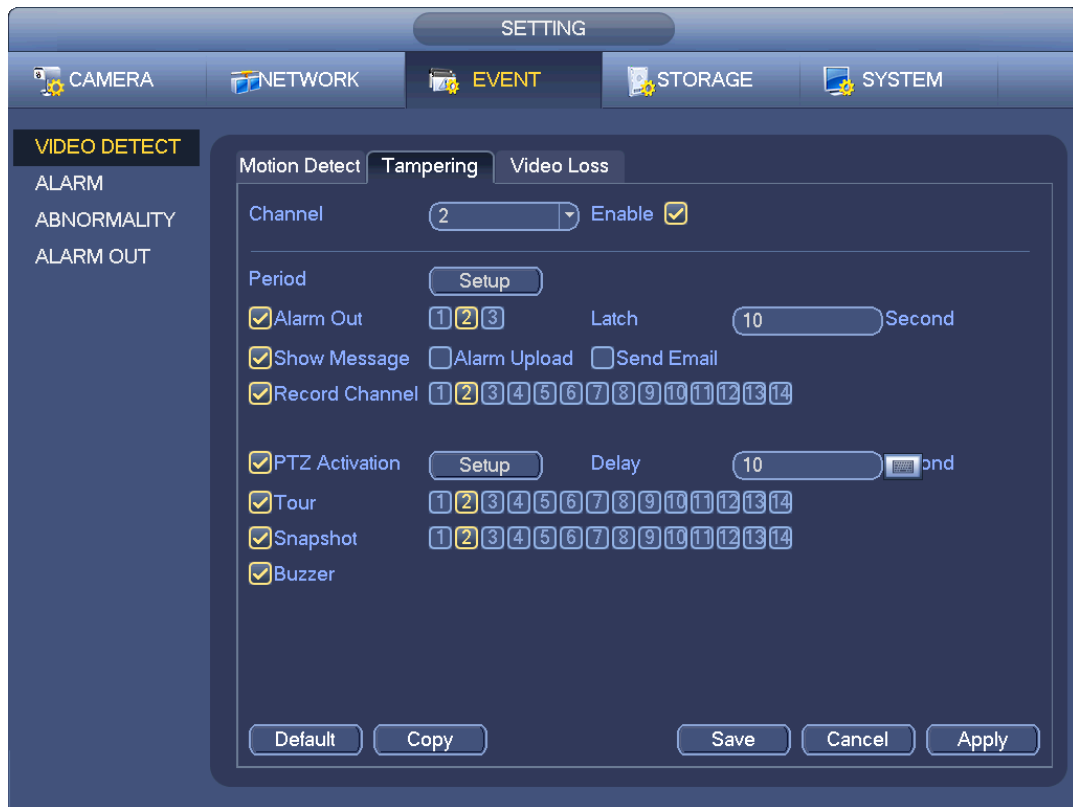

Figure 4-94

4.13.1.3 Video Loss

In Figure 4-89, select video loss from the type list. You can see the interface is shown as in Figure 4-95. This function allows you to be informed when video loss phenomenon occurred. You can enable alarm output channel and then enable show message function.

You can refer to chapter 4.13.1.1 Motion detect for detailed information.

Tips:

You can enable preset/tour/pattern activation operation when video loss occurs.

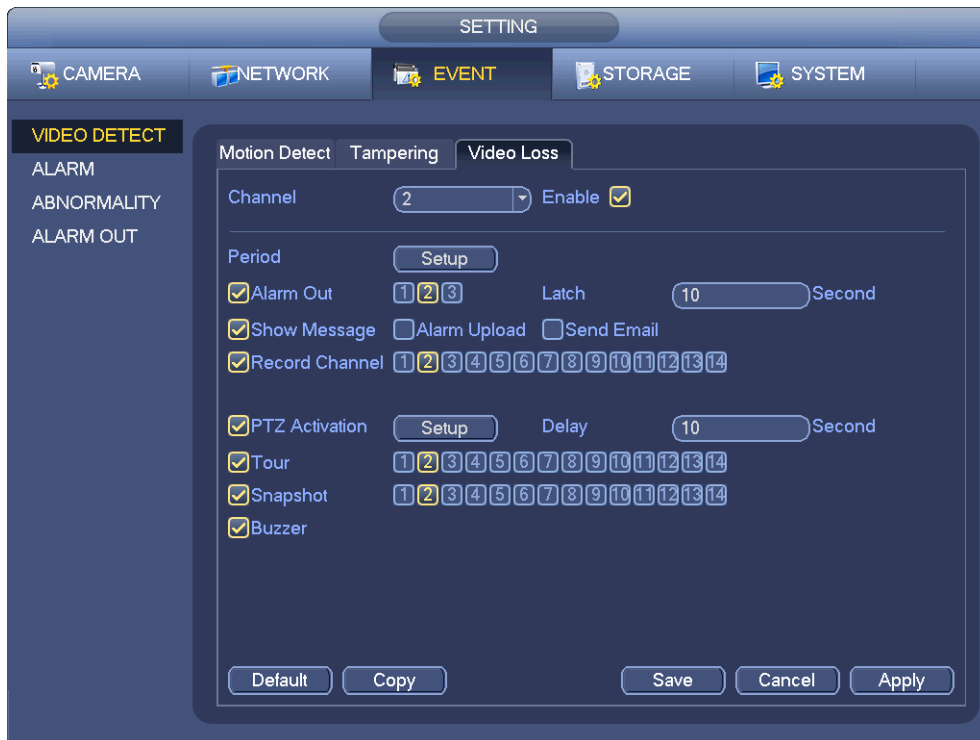

Figure 4-95

4.13.2 IVS (Optional)



Please make sure you are connecting to the smart network camera, otherwise you can not use IVS function!

From main menu->Setting->Event, you can go to the IVS interface. It includes four interfaces: Tripwire/intrusion/object/scene.

4.13.2.1 Tripwire (Optional)

Please make sure you are connecting to the smart network camera, otherwise you can not use IVS function!

System generates an alarm once there is any object crossing the tripwire in the specified direction.

From main menu->Setting->Event->IVS->Tripwire, the interface is shown as below. See Figure 4-96.



Figure 4-96

Check the Enable box to enable tripwire function.

Click Rule setup to draw the tripwire. See Figure 4-97.

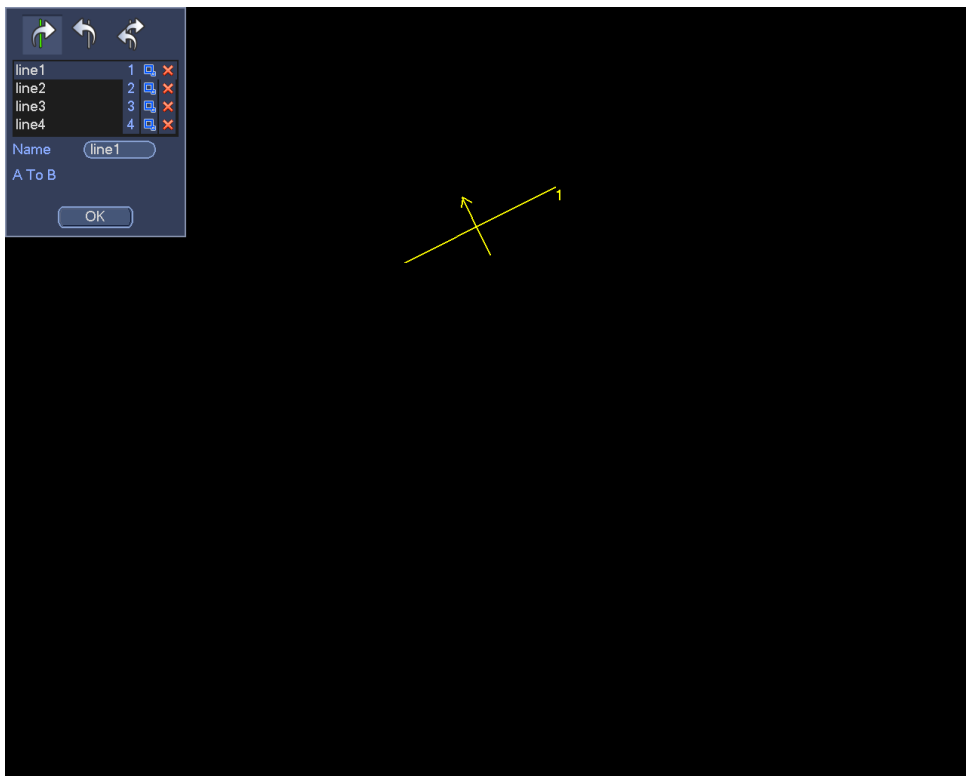

Figure 4-97

Select SN (Line1/2/3/4) and direction, and then input customized rule name.

- Line1/2/3/4: System supports four tripwires. Each SN stands for one tripwire.



- Direction (/ /): System can generate an alarm once there is any object crossing in the specified direction.

Now you can draw a rule. Left click mouse to draw a tripwire. The tripwire can be a direct line, curve or polygon. Right click mouse to complete.

Click to draw filter object.

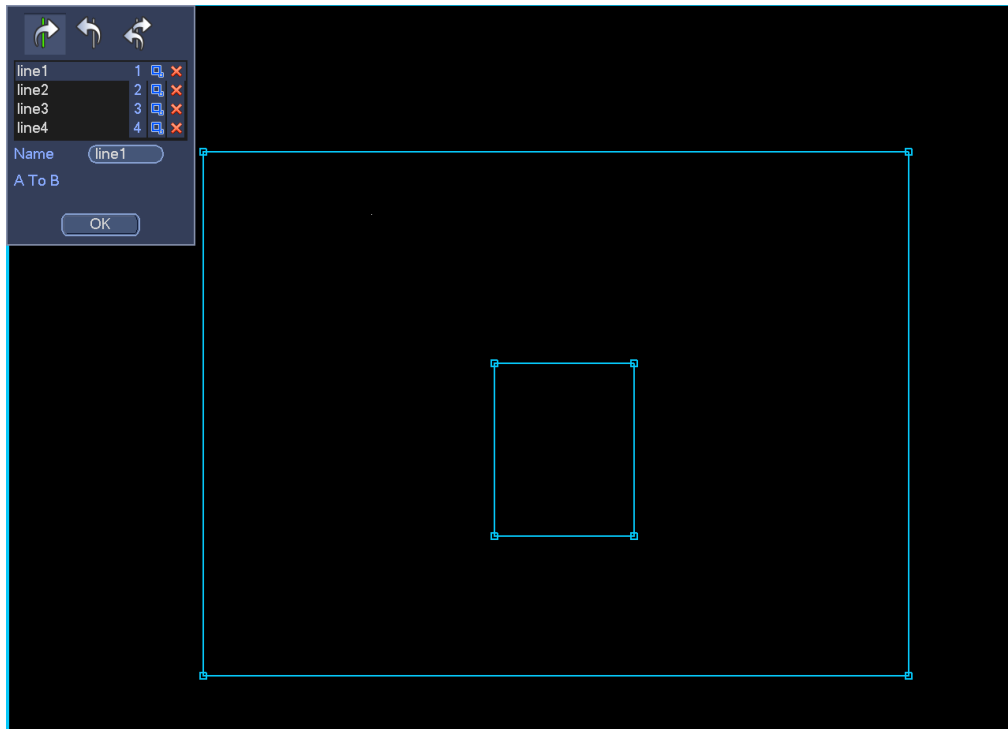

Figure 4-98

Select the blue line and then use mouse to adjust zone size.

Note

Each rule can set two sizes (min size/max size). Once the object is smaller than the min size or larger than the max size, there is no alarm. Please make sure the max size is larger than the min size.

Click Ok to complete the rule setup.

Tips

Click to delete the corresponding rule.

You can refer to the following information to set other parameters.

- Channel: Select a channel from the dropdown list to set tripwire function.
- Enable: Check the box here to enable tripwire function.
- Rule: input customized rule name here.
- Period: Click set button, you can see an interface is shown as in Figure 4-92. Here you can set tripwire period. System only enables tripwire operation in the specified periods. There are two ways for you to set periods. Please note system only supports 6 periods in one day.

✧ In Figure 4-92, Select icon of several dates, all checked items can be edited together. Now

the icon is shown as . Click  to delete a record type from one period.

- ✧ In Figure 4-92. Click button  after one date or a holiday, you can see an interface shown as in Figure 4-93.
- Alarm output: when an alarm occurs, system enables peripheral alarm devices.
- Latch: when tripwire complete, system auto delays detecting for a specified time. The value ranges from 1-300(Unit: second)
- Show message: System can pop up a message to alarm you in the local host screen if you enabled this function.
- Alarm upload: System can upload the alarm signal to the network (including alarm centre) if you enabled current function.
- Send email: System can send out email to alert you when an alarm occurs.
- Record channel: System auto activates tripwire channel(s) to record once an alarm occurs. Please make sure you have set intelligent record in Schedule interface(Main Menu->Setting->Schedule) and schedule record in manual record interface(Main Menu->Advanced->Manual Record)
- PTZ activation: Here you can set PTZ movement when an alarm occurs. Such as go to preset, tour & pattern when there is an alarm. Click “select” button, you can see an interface is shown as in Figure 4-91.
- Record Delay: System can delay the record for specified time after alarm ended. The value ranges from 10s to 300s.
- Tour: Here you can enable tour function when an alarm occurs. System one-window tour.
- Snapshot: You can enable this function to snapshot image when a motion detect alarm occurs.
- Buzzer: Highlight the icon to enable this function. The buzzer beeps when an alarm occurs.

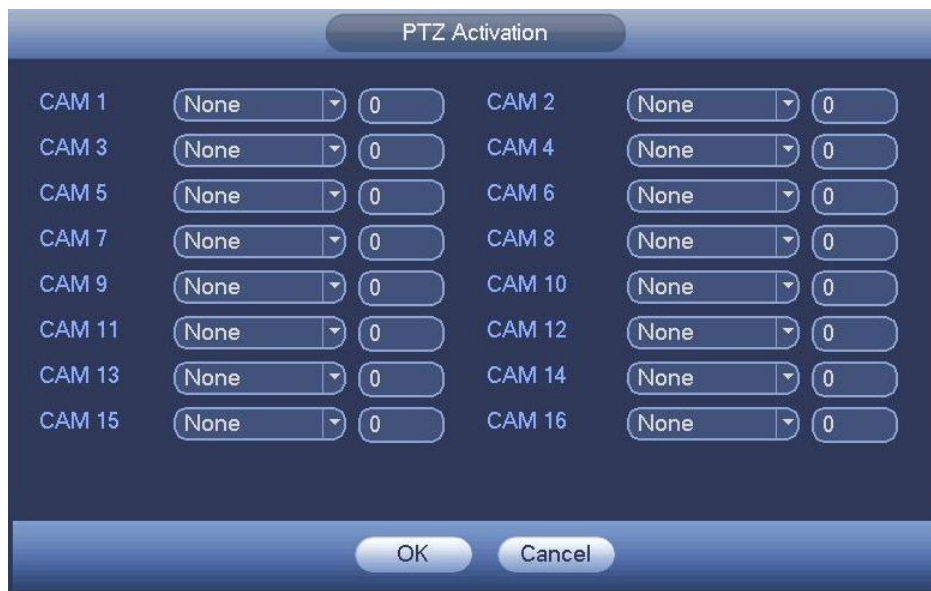

Figure 4-99



Figure 4-100



Figure 4-101

4.13.2.2 Intrusion (Cross warning zone) (Optional)

Please make sure you are connecting to the smart network camera, otherwise you can not use IVS function!

System generates an alarm once there is any object entering or exiting the zone in the specified direction. From main menu->Setting->Event->IVS->Intrusion, the intrusion interface is shown as below. See Figure 4-102.



Figure 4-102

Check the enable box to enable intrusion function.

Click Rule setup to draw the zone. See Figure 4-103.

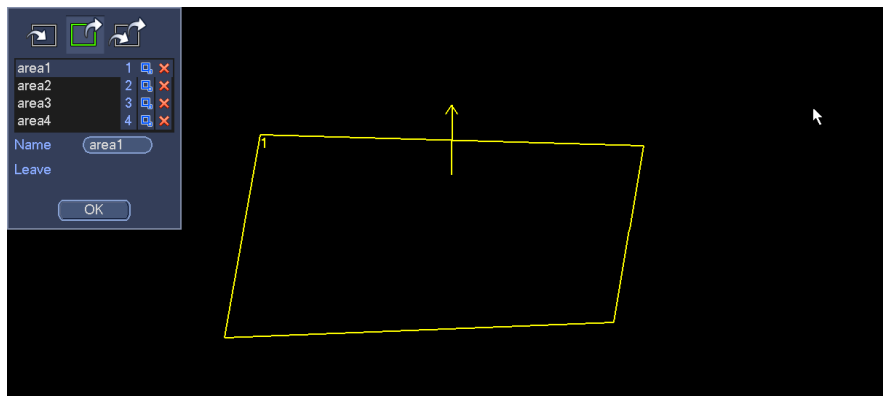

Figure 4-103

Select SN (Area1/2/3/4) and direction, and then input customized rule name.

- Area1/2/3/4: System supports four zones. Each SN stands for one zone.



- Direction (): System can generate an alarm once there is any object enter/exit (Or both) the zone.

Now you can draw a rule. Left click mouse to draw a line first and then right click mouse to draw another line until you draw a rectangle, you can right click mouse to exit.

Click Ok to complete the rule setup.

Tips

Click to delete the corresponding rule.

You can refer to the chapter 4.13.2.1 to set parameters.

4.13.2.3 Object Detect (Optional)

- **Please make sure you are connecting to the smart network camera, otherwise you can not use IVS function!**
 - **For the same channel, the object detect and the intrusion can not be valid at the same time.**
- System generates an alarm when the object missing/abandoned object alarm occurs.

From main menu->Setting->Event->IVS->Object, the object interface is shown as below. See Figure 4-104.



Figure 4-104

Check the enable box to enable object detect function.

Click Rule setup to draw the rule.

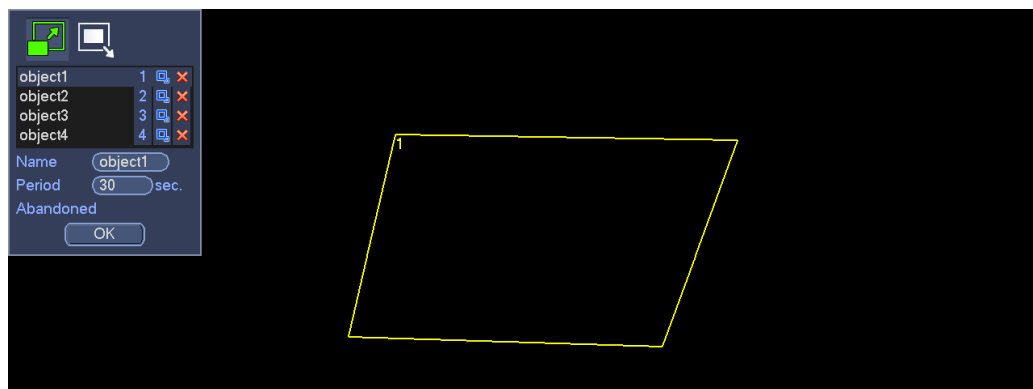





Figure 4-105

Select SN (object1/2/3/4) and direction, and then input customized rule name.

- Object1/2/3/4: System supports four zones. Each SN stands for one zone.

- Direction ( / ): For icon , system can generate an alarm once the object left in the zone for the specified time.. For icon , system can generate an alarm once the object is out of the zone for the specified time.

- Period: It refers to the object in/out the zone time.

Now you can draw a rule. Left click mouse to draw a line, until you draw a rectangle, you can right click mouse.

Click Ok to complete the rule setup.

Tips

Click  to delete the corresponding rule.

You can refer to the chapter 4.13.2.1 to set parameters.

4.13.2.4 Scene Change (Optional)

Please make sure you are connecting to the smart network camera, otherwise you can not use IVS function!

When the detected scene changes, system can generate an alarm.

From main menu->Setting->Event->IVS->Scene change, the interface is shown as in Figure 4-106.



Figure 4-106

You can refer to the chapter 4.13.2.1 to set parameters.

4.13.3 Face Detect (Optional)



Please make sure you are connecting to the smart network camera, otherwise you can not use IVS function!

When camera detects human face, system can generate an alarm.

From main menu->Setting->Event->Face detect, the interface is shown as in Figure 4-107.

- Face ROI: Check the box here, system can enhance the human face display pane.
- Log: Check the box here, system can record face detect log.

You can refer to the chapter 4.13.2.1 to set other parameters.



Figure 4-107

4.13.4 Audio Detect (Optional)



Please make sure you are connecting to the smart network camera, otherwise you can not use IVS function!

System can generate an alarm once it detect the audio input is abnormal or audio volume changes.

From main menu->Setting->Event->Audio detect, you can see an interface shown as in Figure 4-108.

- Input abnormal: Check the box here, system can generate an alarm once the audio input is abnormal.
- Intensity change: Check the box here, system can generate an alarm once the audio volume becomes strong.
- Sensitivity: It refers to the audio recognition sensitivity. The higher the value is, the higher the sensitivity is.

- Threshold: It is to set intensity change threshold. The smaller the value is, the higher the sensitivity is.
 - Log: Check the box here, system can record audio detect alarm log.
- You can refer to the chapter 4.13.2.1 t to set other parameters.



Figure 4-108

4.13.5 Alarm output

From Main menu->Setting->Event->Alarm output, you can see an interface shown as in Figure 4-109. Here is for you to set proper alarm output (Auto/manual/stop). Click OK button of the alarm reset, you can clear all alarm output status.



Figure 4-109

Please highlight icon  to select the corresponding alarm output.

After all the setups please click OK button, system goes back to the previous menu.

4.13.6 Alarm Setup

In the main menu, from Setting->Event->Alarm, you can see alarm setup interface.

- Alarm in: Here is for you to select channel number.



In the main menu, from Setting->Event->Alarm, you can see alarm setup interface. See Figure 4-110.

There are four alarm types. See Figure 4-110 to Figure 4-113.

- ✧ Local alarm: The alarm signal system detects from the alarm input port.
- ✧ Network alarm: It is the alarm signal from the network.
- ✧ IPC external alarm: It is the on-off alarm signal from the front-end device and can activate the local HNVR.
- ✧ IPC offline alarm: Once you select this item, system can generate an alarm when the front-end IPC disconnects with the local HNVR. The alarm can activate record, PTZ, snap and etc. The alarm can last until the IPC and the HNVR connection resumes.

Important

- **If it is your first time to boot up the device, the disconnection status of the front-end network camera will not be regarded as offline. After one successfully connection, all the disconnection events will be regarded as IPC offline event.**
- **When IPC offline alarm occurs, the record and snapshot function of digital channel is null.**
- Enable: Please you need to highlight this button to enable current function.
- Type: normal open or normal close.
- Period: Click set button, you can see an interface is shown as in Figure 4-115. There are two ways for you to set periods. There are max 6 periods in one day. There are four record types: regular, motion detection (MD), Alarm, MD & alarm.
 - ✧ In Figure 4-115, Select icon  of several dates, all checked items can be edited together.

Now the icon is shown as . Click  to delete a record type from one period.
 - ✧ In Figure 4-115. Click button  after one date or a holiday, you can see an interface shown as in Figure 4-116. There are four record types: regular, motion detection (MD), Alarm, MD & alarm.
- PTZ activation: When an alarm occurred, system can activate the PTZ operation. The PTZ activation lasts an anti-dither period. See Figure 4-114.
- Anti-dither: Here you can set anti-dither time. The value ranges from 5 to 600s. The anti-dither time refers to the alarm signal lasts time. It can be seem as the alarm signal activation stays such as the buzzer, tour, PTZ activation, snapshot, channel record. The stay time here does not include the latch time. During the alarm process, the alarm signal can begin an anti-dither time if system detects the local alarm again. The screen prompt, alarm upload, email and etc will not be activated. For example, if you set the anti-dither time as 10 second, you can see the each activation may last 10s if the local alarm is activated. During the process, if system detects another local alarm signal at the fifth second, the buzzer, tour, PTZ activation, snapshot, record channel will begin another 10s while the

screen prompt, alarm upload, email will not be activated again. After 10s, if system detects another alarm signal, it can generate an alarm since the anti-dither time is out.

- Alarm output: The number here is the device alarm output port. You can select the corresponding ports(s) so that system can activate the corresponding alarm device(s) when an alarm occurred.
- Latch: When the anti-dither time ended, the channel alarm you select in the alarm output may last the specified period. The value ranges from 1 to 300 seconds. This function is not for other alarm activation operations. The latch is still valid even you disable the alarm event function directly.
- Show message: System can pop up a message to alarm you in the local host screen if you enabled this function.
- Alarm upload: System can upload the alarm signal to the network (including alarm centre and the WEB) if you enabled current function. System only uploads the alarm channel status. You can go to the WEB and then go to the Alarm interface to set alarm event and alarm operation. Please go to the Network interface to set alarm centre information.
- Send email: System can send out the alarm signal via the email to alert you when alarm occurs. Once you enable the snap function, system can also send out an image as the attachment. Please go to the Main Menu->Setting ->Network->Email interface to set.
- Record channel: you can select proper channel to record alarm video (Multiple choices).
 - ◇ You need to set alarm record mode as Schedule in Record interface (Main Menu->Advanced->Record). Please note the manual record has the highest priority. System record all the time no matter there is an alarm or not if you select Manual mode.
 - ◇ Now you can go to the Schedule interface (Main Menu->Setting->Schedule) to set the record type, corresponding channel number, week and date. You can select the record type:Regular/MD/Alarm/MD&Alarm. Please note, you can not select the MD&Alarm and MD(or Alarm) at the same time.
 - ◇ Now you can go to the Encode interface to select the alarm record and set the encode parameter (Main Menu->Setting->Encode).
 - ◇ Finally, you can set the alarm input as the local alarm and then select the record channel. The select channel begins alarm record when an alarm occurred. Please note system begins the alarm record instead of the MD record if the local alarm and MD event occurred at the same time.
- Tour: Here you can enable tour function when an alarm occurs. System supports 1/8-window tour. Please go to chapter4.7.4.2 Display for tour interval setup. Please note the tour setup here has higher priority than the tour setup you set in the Display interface. Once there two tours are both enabled, system can enable the alarm tour as you set here when an alarm occurred. If there is no alarm, system implements the tour setup in the Display interface.
- Snapshot: You can enable this function to snapshot image when an alarm occurs.
- Buzzer: Highlight the icon to enable this function. The buzzer beeps when an alarm occurs.



Figure 4-110

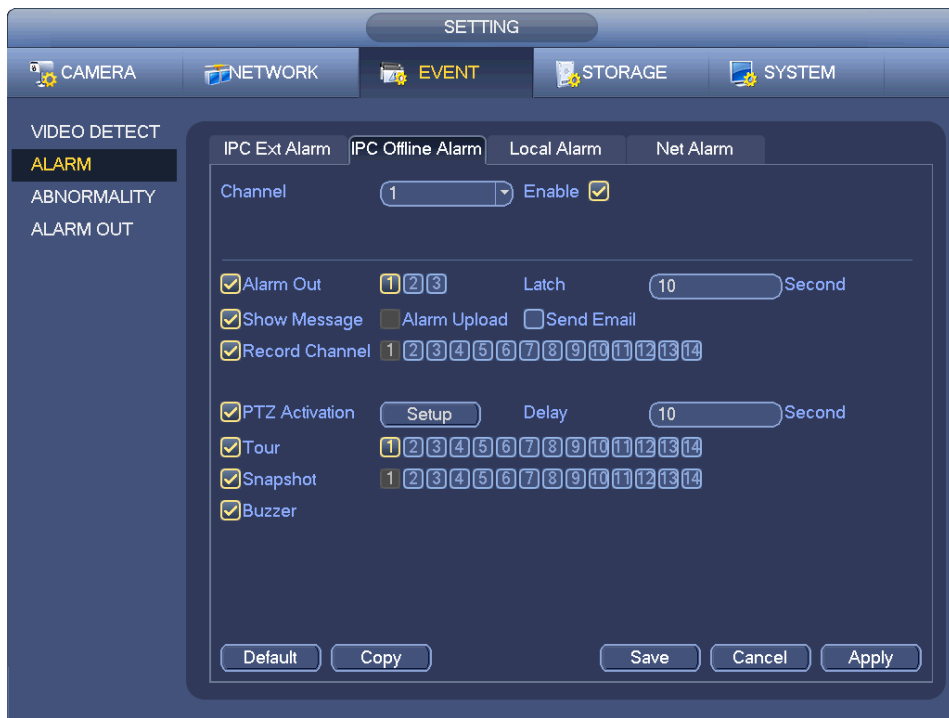

Figure 4-111



Figure 4-112

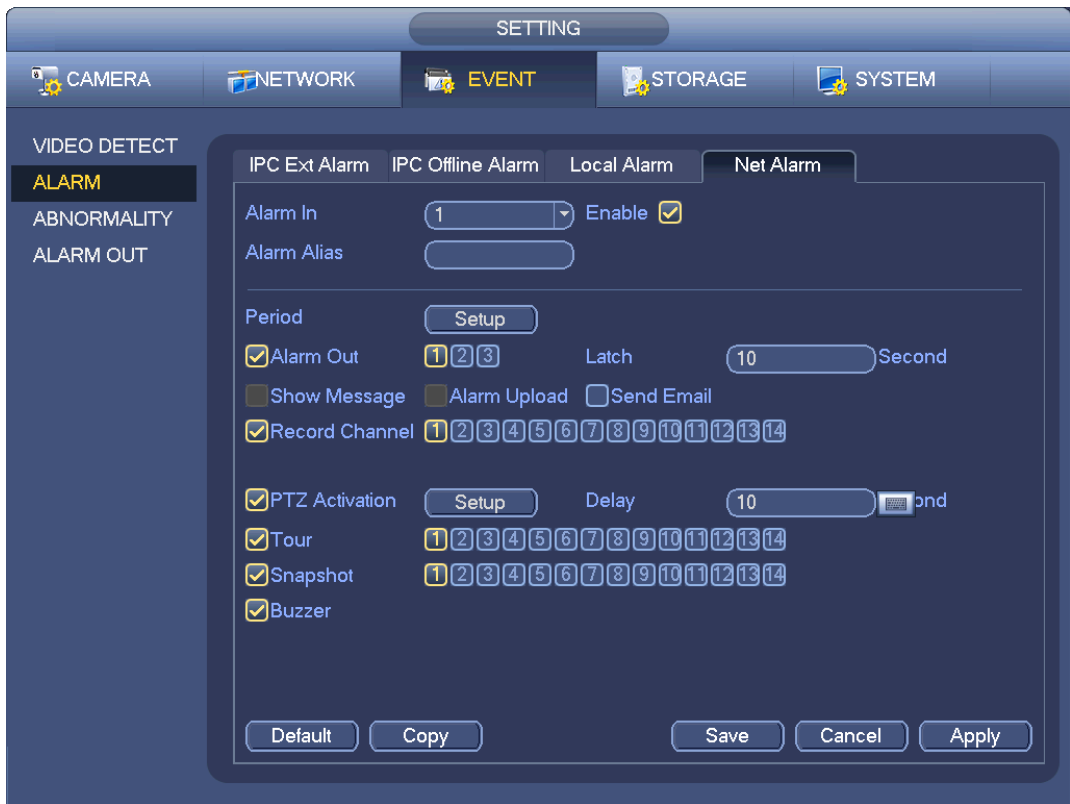

Figure 4-113



Figure 4-114



Figure 4-115



Figure 4-116

Please highlight icon  to select the corresponding function. After setting all the setups please click save button, system goes back to the previous menu.

4.13.7 Abnormality

There are two types: Disk/Network.

- ✧ Disk: Disk error, no disk, no space. See Figure 4-117 and Figure 4-118.
- ✧ Network: Disconnection, IP conflict, MAC conflict. See Figure 4-119.
- Alarm output: Please select alarm activation output port (multiple choices).
- Less than: System can alarm you when the HDD space is less than the threshold you set here (For HDD no space type only).
- Latch: Here you can set corresponding delaying time. The value ranges from 1s-300s. System automatically delays specified seconds in turning off alarm and activated output after external alarm cancelled.
- Show message: system can pop up the message in the local screen to alert you when alarm occurs.
- Alarm upload: System can upload the alarm signal to the network (including alarm centre) if you enabled current function. For disconnection event, IP conflict event and MAC conflict event, this function is null.
- Send email: System can send out email to alert you when alarm occurs.
- Buzzer: Highlight the icon to enable this function. The buzzer beeps when an alarm occurs.

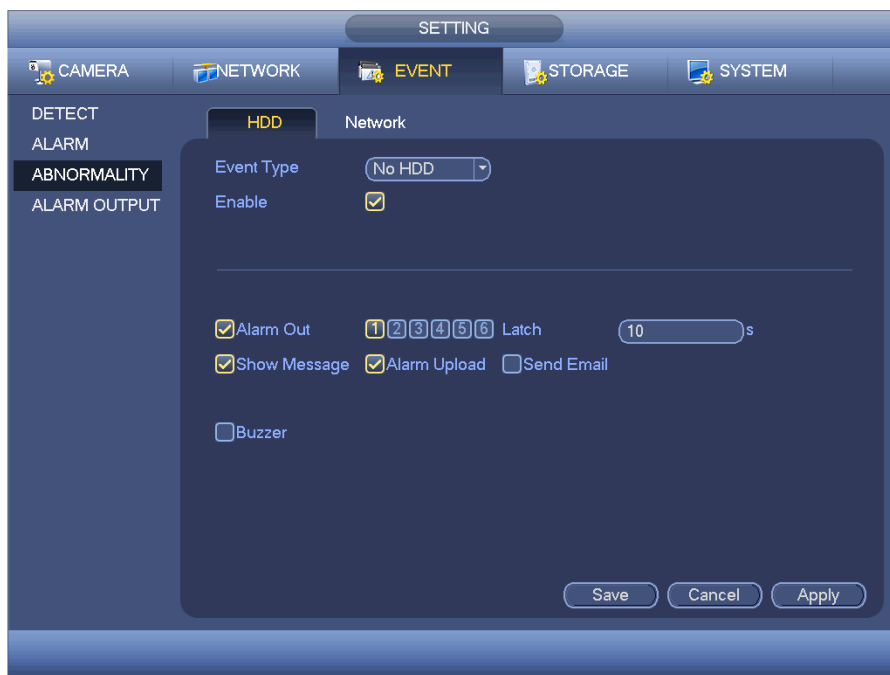

Figure 4-117



Figure 4-118

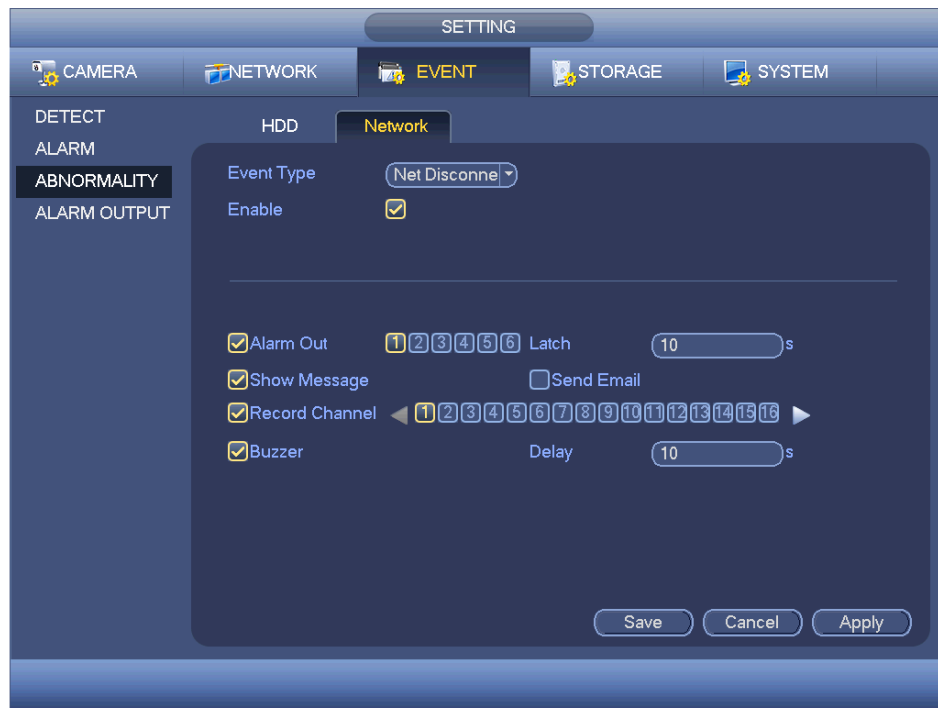

Figure 4-119

4.14 Network

4.14.1.1 TCP/IP

The single network adapter interface is shown as in Figure 4-120 and the dual network adapters interface is shown as in Figure 4-121.

- Network Mode : Includes multiple access, fault tolerance, and load balancing
 - ✧ Multiple-address mode: eth0 and eth1 operate separately. You can use the services such as HTTP, RTP service via eth0 or the eth1. Usually you need to set one default card (default setup is eth0) to request the auto network service form the device-end such as DHCP, email, FTP and etc. In multiple-address mode, system network status is shown as offline once one card is offline.
 - ✧ Network fault-tolerance: In this mode, device uses bond0 to communicate with the external devices. You can focus on one host IP address. At the same time, you need to set one master card. Usually there is only one running card (master card).System can enable alternate card when the master card is malfunction. The system is shown as offline once these two cards are both offline. Please note these two cards shall be in the same LAN.
 - ✧ Load balance: In this mode, device uses bond0 to communicate with the external device. The eth0 and eth1 are both working now and bearing the network load. Their network load are general the same. The system is shown as offline once these two cards are both offline. Please note these two cards shall be in the same LAN.
- Default Network Card: Please select eth0/eth1/bond0(optional) after enable multiple-access function
- Main Network Card: Please select eth0/eth1 (optional).after enable multiple access function.

Note: The dual-Ethernet port series support the above three configurations and supports functions as multiple-access, fault-tolerance and load balancing.

- IP Version: There are two options: IPv4 and IPv6. Right now, system supports these two IP address format and you can access via them.
- MAC address: The host in the LAN can get a unique MAC address. It is for you to access in the LAN. It is read-only.
- IP address: Here you can use up/down button (▲▼) or input the corresponding number to input IP address. Then you can set the corresponding subnet mask the default gateway.
- Default gateway: Here you can input the default gateway. Please note system needs to check the validity of all IPv6 addresses. The IP address and the default gateway shall be in the same IP section. That is to say, the specified length of the subnet prefix shall have the same string.
- DHCP: It is to auto search IP. When enable DHCP function, you can not modify IP/Subnet mask /Gateway. These values are from DHCP function. If you have not enabled DHCP function, IP/Subnet mask/Gateway display as zero. You need to disable DHCP function to view current IP information. Besides, when PPPoE is operating, you can not modify IP/Subnet mask /Gateway.
- MTU: It is to set MTU value of the network adapter. The value ranges from 1280-7200 bytes. The default setup is 1500 bytes. Please note MTU modification may result in network adapter reboot and network becomes off. That is to say, MTU modification can affect current network service. System may pop up dialog box for you to confirm setup when you want to change MTU setup. Click OK button to confirm current reboot, or you can click Cancel button to terminate current modification. Before the modification, you can check the MTU of the gateway; the MTU of the NVR shall be the same as or is lower than the MTU of the gateway. In this way, you can reduce packets and enhance network transmission efficiency.

The following MTU value is for reference only.

- ◇ 1500: Ethernet information packet max value and it is also the default value. It is the typical setup when there is no PPPoE or VPN. It is the default setup of some router, switch or the network adapter.
- ◇ 1492: Recommend value for PPPoE.
- ◇ 1468: Recommend value for DHCP.
- Preferred DNS server: DNS server IP address.
- Alternate DNS server: DNS server alternate address.
- Transfer mode: Here you can select the priority between fluency/video qualities.
- LAN download: System can process the downloaded data first if you enable this function. The download speed is 1.5X or 2.0X of the normal speed.
- LAN download: System can process the downloaded data first if you enable this function. The download speed is 1.5X or 2.0X of the normal speed.

After completing all the setups please click save button, system goes back to the previous menu.



Figure 4-120



Figure 4-121

4.14.1.2 Connection

The connection setup interface is shown as in Figure 4-122.

- Max connection: system support maximal 128 users. 0 means there is no connection limit.
- TCP port: Default value is 37777.

- UDP port: Default value is 37778.
- HTTP port: Default value is 80.
- HTTPS port: Default value is 443.
- RTSP port: Default value is 554.

Important: System needs to reboot after you changed and saved any setup of the above four ports. Please make sure the port values here do not conflict.



Figure 4-122

4.14.1.3 WIFI AP

Note

This function is for some series product only.

4.14.1.3.1 WIFI AP

The WIFI AP interface is shown as below. See Figure 4-123. Here you can set WIFI hotspot, so that the network camera can use the hotspot to connect to the network.

- 2.4GHz/5GHz: Please check the box to enable the function.
- SSID: It is to set SSID name. You can use this name to search the device.
- Password: It is to set SSID password. You can use this password to connect to the network.
- Security: Select authentication mode from the dropdown list.
- Channel: Please select a channel from the dropdown list. The default setup is auto.
- Mode: There three options: high/middle/low. Please select from the dropdown list.



Figure 4-123

4.14.1.3.2 Advanced

Click Advanced, you can see an interface shown as below. See Figure 4-124.

- IPv4 address: Input WIFI AP IP address.
- IPv4 netmask: Input WIFI AP network mask.
- IPv4 gateway: Input WIFI AP gateway.
- Start IP/End IP: Input start IP and end IP of the network cameras. The NVR can allocate the IP addresses in the range you specified here.
- Upgrade: Click it to upgrade WIFI AP module.



Figure 4-124

4.14.1.4 WIFI

The WIFI interface is shown as below. See Figure 4-125.

- Enable: Check the box here to enable WIFI function.
- Refresh: You can click it to search the hotspot list again. It can automatically add the information such as the password if you have set it before.
- Disconnect: Here you can click it to turn off the connection.
- Connect: Here you can click it to connect to the hotspot. System needs to turn off current connection and then connect to a new hotspot if there is connection of you selected one.

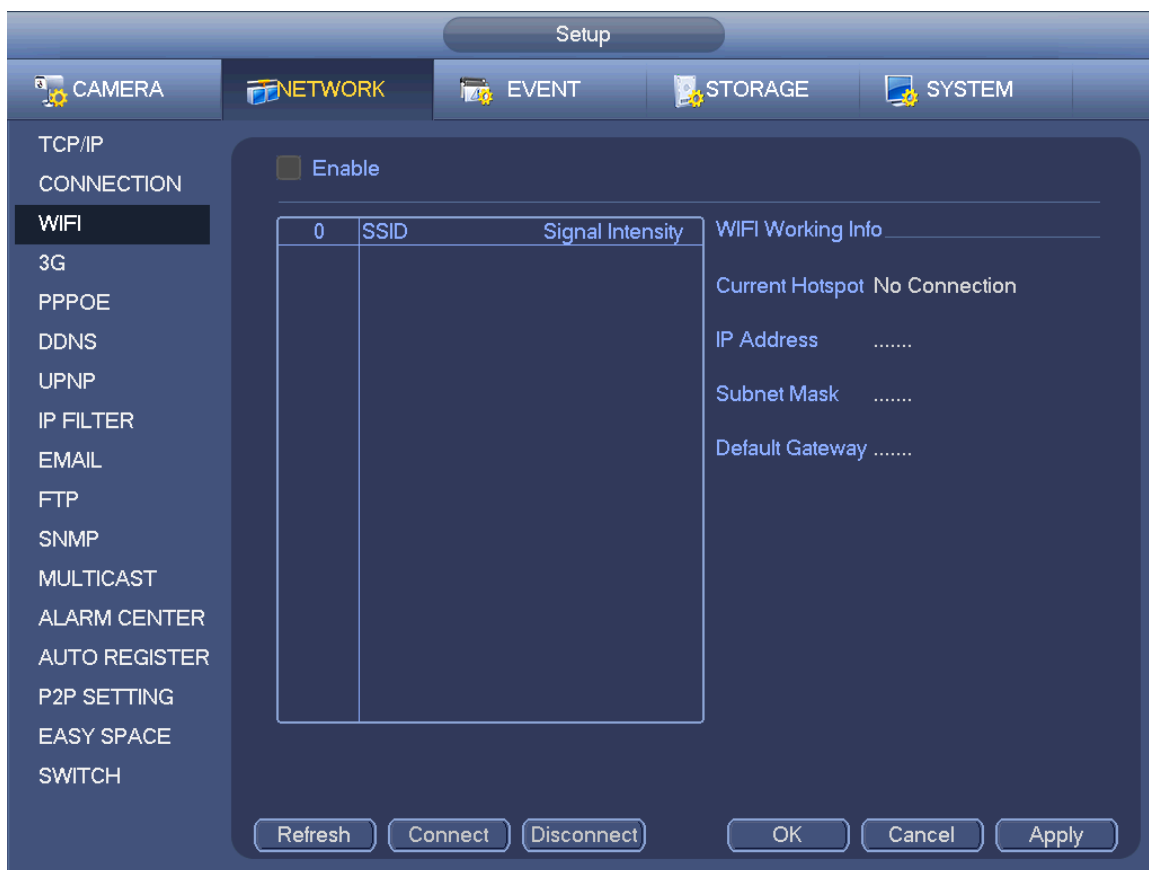

Figure 4-125

- WIFI working status: Here you can view current connection status.

Please note:

- After successful connection, you can see WIFI connection icon at the top right corner of the preview interface.
- When the hotspot verification type is WEP, system displays as AUTO since the device can not detect its encryption type.
- System does not support verification type WPA and WPA2. The display may become abnormal for the verification type and encryption type.

After device successfully connected to the WIFI, you can view the hotspot name, IP address, subnet mask, default gateway and etc. Right now system support TOTOLINK_N2200UP module.

4.14.1.5 3G

3G setup interface is shown as below. See Figure 4-126.

Please refer to the following contents for the parameter information.

- Pane 1: Display 3G signal intensity after you enabled 3G function.
- Pane 2: Display 3G module configuration information after you enabled 3G function.
- Pane 3: Display 3G module status information after you enabled 3G function.

It is to display current wireless network signal intensity such as EVDO, CDMA1x, WCDMA, WCDMA, EDGE and etc.

- 3G module: It is to display current wireless network adapter name.
- 3G Enable/Disable: Check the box here to enable 3G module.
- Network type: There are various network types for different 3G network modules. You can select according to your requirements.

- APN: It is the wireless connection server. It is to set you access the wireless network via which method.
- AUTH: It is the authentication mode. It supports PAP/CHAP.
- Dial number: Please input 3G network dialup number you got from your ISP.
- User name: It is the user name for you to login the 3G network.
- Password: It is the password for you to login the 3G network.
- Pulse interval: You can set dialup duration. Once you disable the extra stream, the connection time begins. For example, if you input 5 seconds here, then 3G network connection period is 5 seconds. The device automatically disconnect when time is up. If there is no extra stream, 3G network connection is valid all the time. **If the alive time is 0, then the 3G network connection is valid all the time.**
- Dial: Here you can enable or disable 3G network connection/disconnection manually.
- 3G wireless network: Here is to display wireless network status, SIM card status, dial status. If the 3G connection is OK, then you can see the device IP address the wireless network automatically allocates.

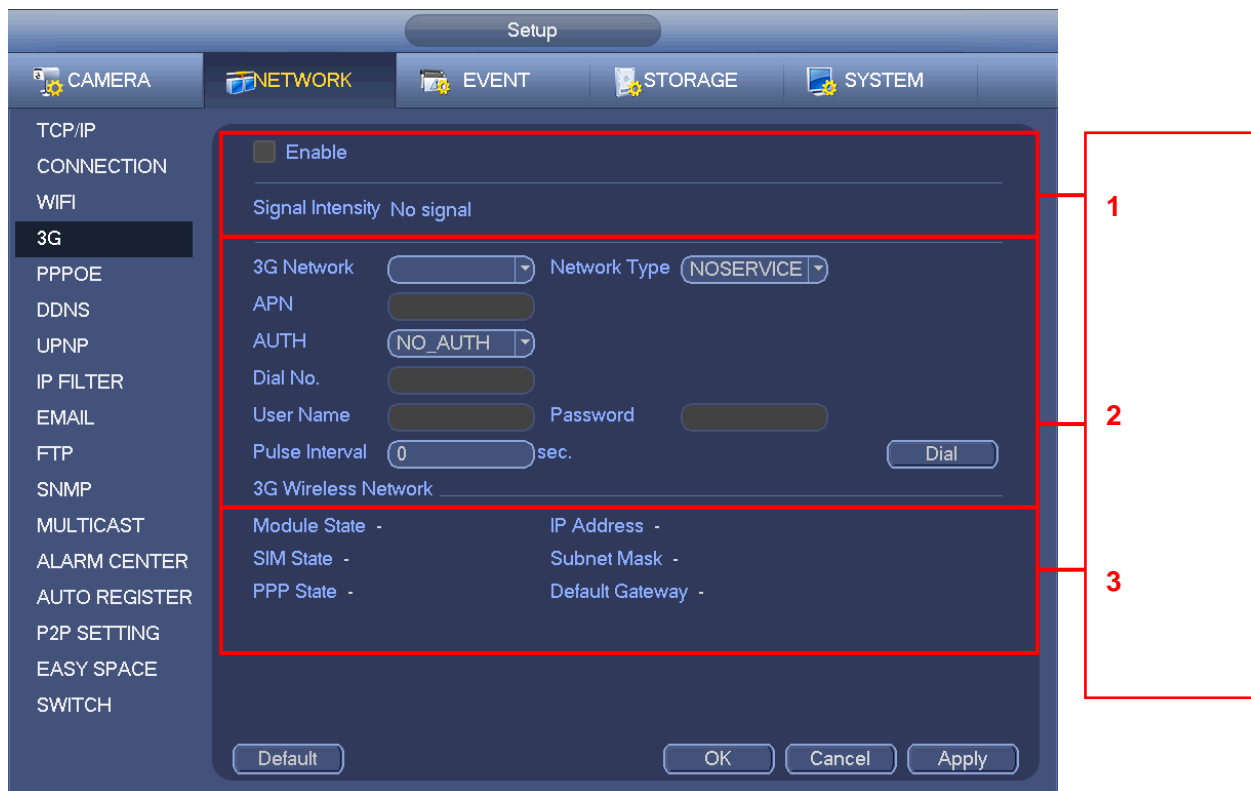

Figure 4-126

4.14.1.6 PPPoE

PPPoE interface is shown as in Figure 4-127.

Input “PPPoE name” and “PPPoE password” you get from your ISP (Internet service provider).

Click save button, you need to restart to activate your configuration.

After rebooting, NVR will connect to internet automatically. The IP in the PPPoE is the NVR dynamic value. You can access this IP to visit the unit.



Figure 4-127

4.14.1.7 DDNS

DDNS setup interface is shown as in Figure 4-128.

You need a PC of fixed IP in the internet and there is the DDNS software running in this PC. In other words, this PC is a DNS (domain name server).

In network DDNS, please select DDNS type and highlight enable item. And then please input your PPPoE name you get from you IPS and server IP (PC with DDNS). Click save button and then reboot system.

Click save button, system prompts for rebooting to get all setup activated.

After rebooting, open IE and input as below:

http: //(DDNS server IP)/(virtual directory name)/webtest.htm

e.g.: http: //10.6.2.85/NVR_DDNS/webtest.htm.)

Now you can open DDNSServer web search page.



Figure 4-128

Please note DDNS type includes: CN99 DDNS, NO-IP DDNS, Quick DDNS, Dyndns DDNS and sysdns DDNS. All the DDNS can be valid at the same time, you can select as you requirement.

Private DDNS function shall work with special DDNS server and special Professional Surveillance Software (PSS).

Dahua DDNS and Client-end Introduction

1) Background Introduction

Device IP is not fixed if you use ADSL to login the network. The DDNS function allows you to access the NVR via the registered domain name. Besides the general DDNS, the Dahua DDNS works with the device from the manufacturer so that it can add the extension function.

2) Function Introduction

The Dahua DDNS client has the same function as other DDNS client end. It realizes the bonding of the domain name and the IP address. Right now, current DDNS server is for our own devices only. You need to refresh the bonding relationship of the domain and the IP regularly. There is no user name, password or the ID registration on the server. At the same time, each device has a default domain name (Generated by MAC address) for your option. You can also use customized valid domain name (has not registered.).

3) Operation

Before you use Dahua DDNS, you need to enable this service and set proper server address, port value and domain name.

- Server address: www.dahuaddns.com
- Port number: 80
- Domain name: There are two modes: Default domain name and customized domain name.

Except default domain name registration, you can also use customized domain name (You can input your self-defined domain name.) After successful registration, you can use domain name to login installed of

the device IP.

- User name: It is optional. You can input your commonly used email address.

Important

- Do not register frequently. The interval between two registrations shall be more than 60 seconds. Too many registration requests may result in server attack.
- System may take back the domain name that is idle for one year. You can get a notification email before the cancel operation if your email address setup is OK.

4.14.1.8 UPnP

The UPNP protocol is to establish a mapping relationship between the LAN and the WAN. Please input the router IP address in the LAN in Figure 4-120. See Figure 4-129.

- UPNP on/off : Turn on or off the UPNP function of the device.
- Status: When the UPNP is offline, it shows as “Unknown”. When the UPNP works it shows “Success”
- Router LAN IP: It is the router IP in the LAN.
- WAN IP: It is the router IP in the WAN.
- Port Mapping list: The port mapping list here is the one to one relationship with the router’s port mapping setting.
- List:
 - ◇ Service name: Defined by user.
 - ◇ Protocol: Protocol type
 - ◇ Internal port: Port that has been mapped in the router.
 - ◇ External port: Port that has been mapped locally.
- Default: UPNP default port setting is the HTTP, TCP and UDP of the NVR.
- Add to the list: Click it to add the mapping relationship.
- Delete: Click it to remove one mapping item.

Double click one item; you can change the corresponding mapping information. See Figure 4-130.

Important:

When you are setting the router external port, please use 1024~5000 port. Do not use well-known port 1~255 and the system port 256~1023 to avoid conflict.

For the TCP and UDP, please make sure the internal port and external port are the same to guarantee the proper data transmission.



Figure 4-129



Figure 4-130

4.14.1.9 IP Filter

IP filter interface is shown as in Figure 4-131. You can add IP in the following list. The list supports max 64 IP addresses. System supports valid address of IPv4 and IPv6. **Please note system needs to check the validity of all IPv6 addresses and implement optimization.**

After you enabled trusted sites function, only the IP listed below can access current NVR.

If you enable blocked sites function, the following listed IP addresses can not access current NVR.

- Enable: Highlight the box here, you can check the trusted site function and blocked sites function. You can not see these two modes if the Enable button is grey.

- **Type:** You can select trusted site and blacklist from the dropdown list. You can view the IP address on the following column.
- **Start address/end address:** Select one type from the dropdown list, you can input IP address in the start address and end address. Now you can click Add IP address or Add IP section to add.
 - a) For the newly added IP address, it is in enable status by default. Remove the \surd before the item, and then current item is not in the list.
 - b) System max supports 64 items.
 - c) Address column supports IPv4 or IPv6 format. If it is IPv6 address, system can optimize it. For example, system can optimize aa:0000: 00: 00aa: 00aa: 00aa: 00aa: 00aa as aa:: aa: aa: aa: aa: aa: aa.
 - d) System automatically removes space if there is any space before or after the newly added IP address.
 - e) System only checks start address if you add IP address. System check start address and end address if you add IP section and the end address shall be larger than the start address.
 - f) System may check newly added IP address exists or not. System does not add if input IP address does not exist.
- **Delete:** Click it to remove specified item.
- **Edit:** Click it to edit start address and end address. See Figure 4-132. System can check the IP address validity after the edit operation and implement IPv6 optimization.
- **Default:** Click it to restore default setup. In this case, the trusted sites and blocked sites are both null.

Note:

- If you enabled trusted sites, only the IP in the trusted sites list can access the device.
- If you enabled blocked sites, the IP in the blocked sites can not access the device.
- System supports add MAC address.

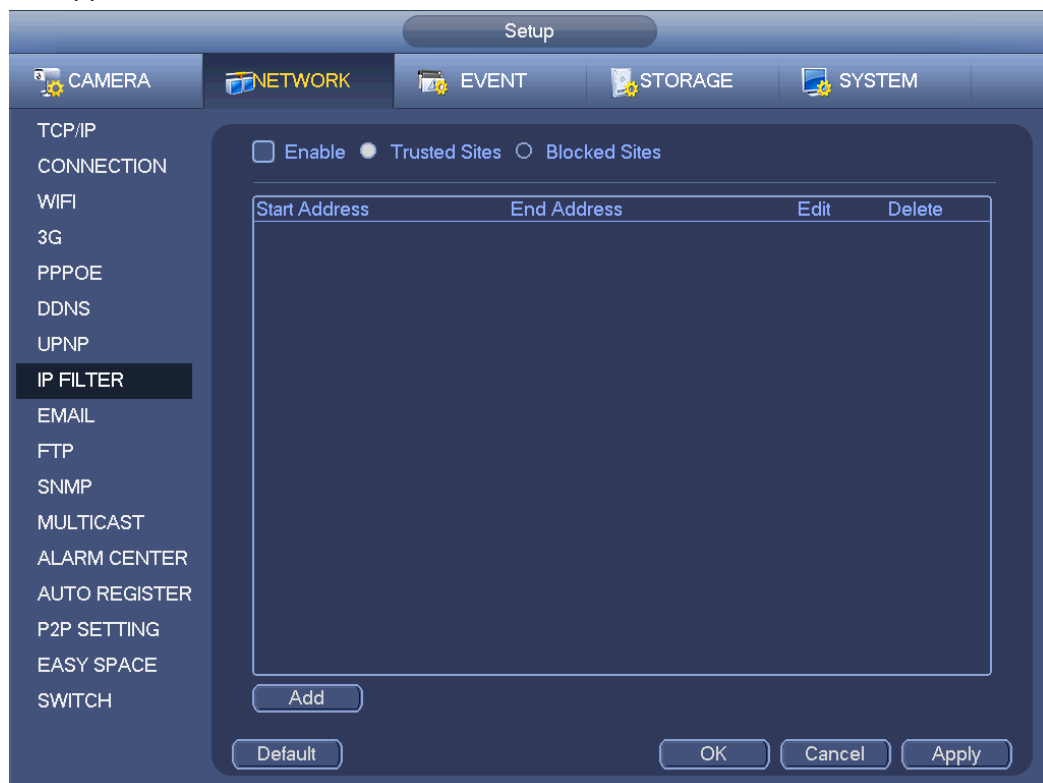

Figure 4-131

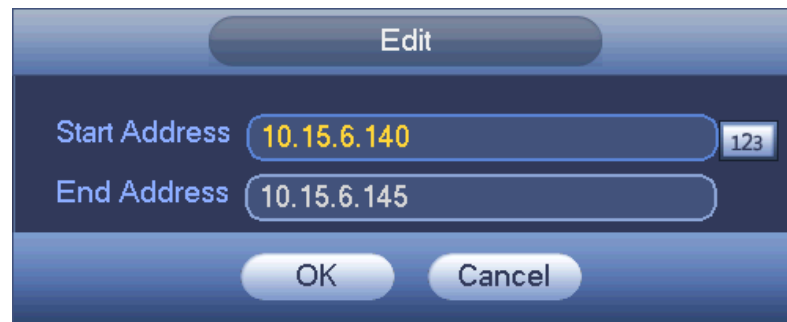

Figure 4-132

4.14.1.10 Email

The email interface is shown as below. See Figure 4-133.

- SMTP server: Please input your email SMTP server IP here.
- Port: Please input corresponding port value here.
- User name: Please input the user name to login the sender email box.
- Password: Please input the corresponding password here.
- Sender: Please input sender email box here.
- Title: Please input email subject here. System support English character and Arabic number. Max 32-digit.
- Receiver: Please input receiver email address here. System max supports 3 email boxes. System automatically filters same addresses if you input one receiver repeatedly.
- SSL enable: System supports SSL encryption box.
- Interval: The send interval ranges from 0 to 3600 seconds. 0 means there is no interval.
- Health email enable: Please check the box here to enable this function. This function allows the system to send out the test email to check the connection is OK or not.
- Interval: Please check the above box to enable this function and then set the corresponding interval. System can send out the email regularly as you set here. Click the Test button, you can see the corresponding dialogue box to see the email connection is OK or not.

Please note system will not send out the email immediately when the alarm occurs. When the alarm, motion detection or the abnormality event activates the email, system sends out the email according to the interval you specified here. This function is very useful when there are too many emails activated by the abnormality events, which may result in heavy load for the email server.

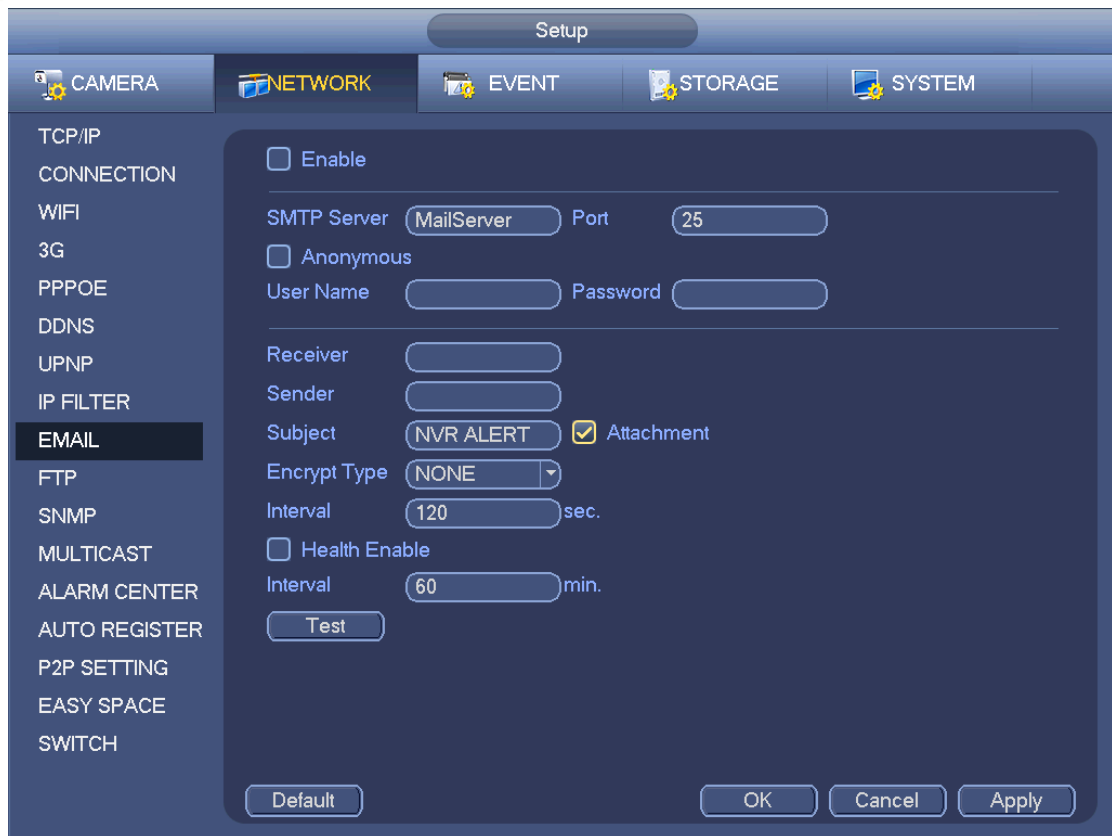

Figure 4-133

4.14.1.11 FTP

You need to download or buy FTP service tool (such as Ser-U FTP SERVER) to establish FTP service. Please install Ser-U FTP SERVER first. From “start” -> “program” -> Serv-U FTP Server -> Serv-U Administrator. Now you can set user password and FTP folder. Please note you need to grant write right to FTP upload user. See Figure 4-134.

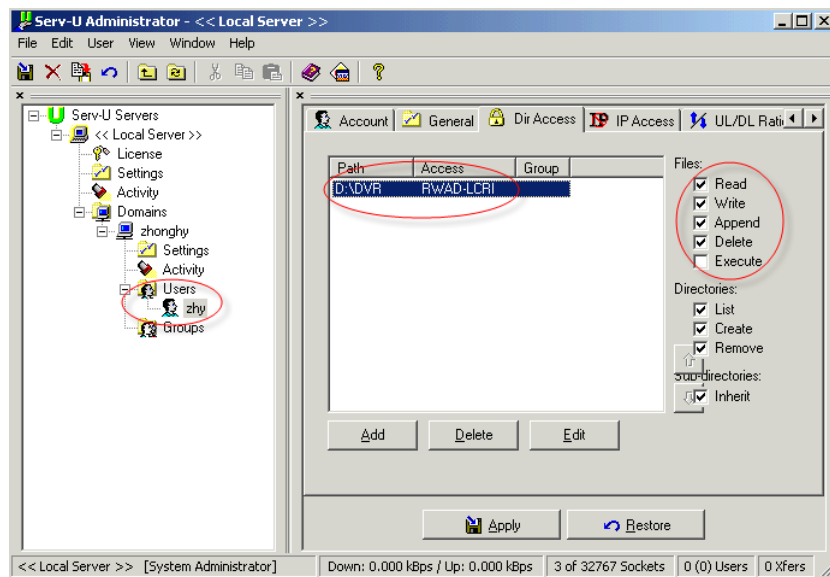

Figure 4-134

You can use a PC or FTP login tool to test setup is right or not.

For example, you can login user ZHY to FTP://10.10.7.7 and then test it can modify or delete folder

or not. See Figure 4-135.



Figure 4-135

System also supports upload multiple NVRs to one FTP server. You can create multiple folders under this FTP.

FTP interface is shown as in Figure 4-136.

Please highlight the icon  in front of Enable to activate FTP function.

Here you can input FTP server address, port and remote directory. When remote directory is null, system automatically create folders according to the IP, time and channel.

User name and password is the account information for you to login the FTP.

File length is upload file length. When setup is larger than the actual file length, system will upload the whole file. When setup here is smaller than the actual file length, system only uploads the set length and auto ignore the left section. When interval value is 0, system uploads all corresponding files.

After completed channel and weekday setup, you can set two periods for one each channel.

Click the Test button, you can see the corresponding dialogue box to see the FTP connection is OK or not.



Figure 4-136

4.14.1.12 SNMP

SNMP is an abbreviation of Simple Network Management Protocol. It provides the basic network management frame of the network management system. The SNMP widely used in many environments. It is used in many network device, software and system.

You can set in the following interface. See Figure 4-137.



Figure 4-137

Please enable the SNMP function. Use the corresponding software tool (MIB Builder and MG-SOFT MIB Browser). You still need two MIB file: BASE-SNMP-MIB, NVR-SNMP-MIB) to connect to the device. You can get the device corresponding configuration information after successfully connection.

Please follow the steps listed below to configure.

- In Figure 4-137, check the box to enable the SNMP function. Input the IP address of the PC than is running the software in the Trap address. You can use default setup for the rest items.
- Compile the above mentioned two MIB file via the software MIB Builder.
- Run MG-SOFT MIB Browser to load the file from the previous step to the software.
- Input the device IP you want to manage in the MG-SOFT MIB Browser. Please set the corresponding version for your future reference.
- Open the tree list on the MG-SOFT MIB Browser; you can get the device configuration. Here you can see the device has how many video channels, audio channels, application version and etc.

Note

Port conflict occurs when SNMP port and Trap port are the same.

4.14.1.13 Multicast

Multicast setup interface is shown as in Figure 4-138.

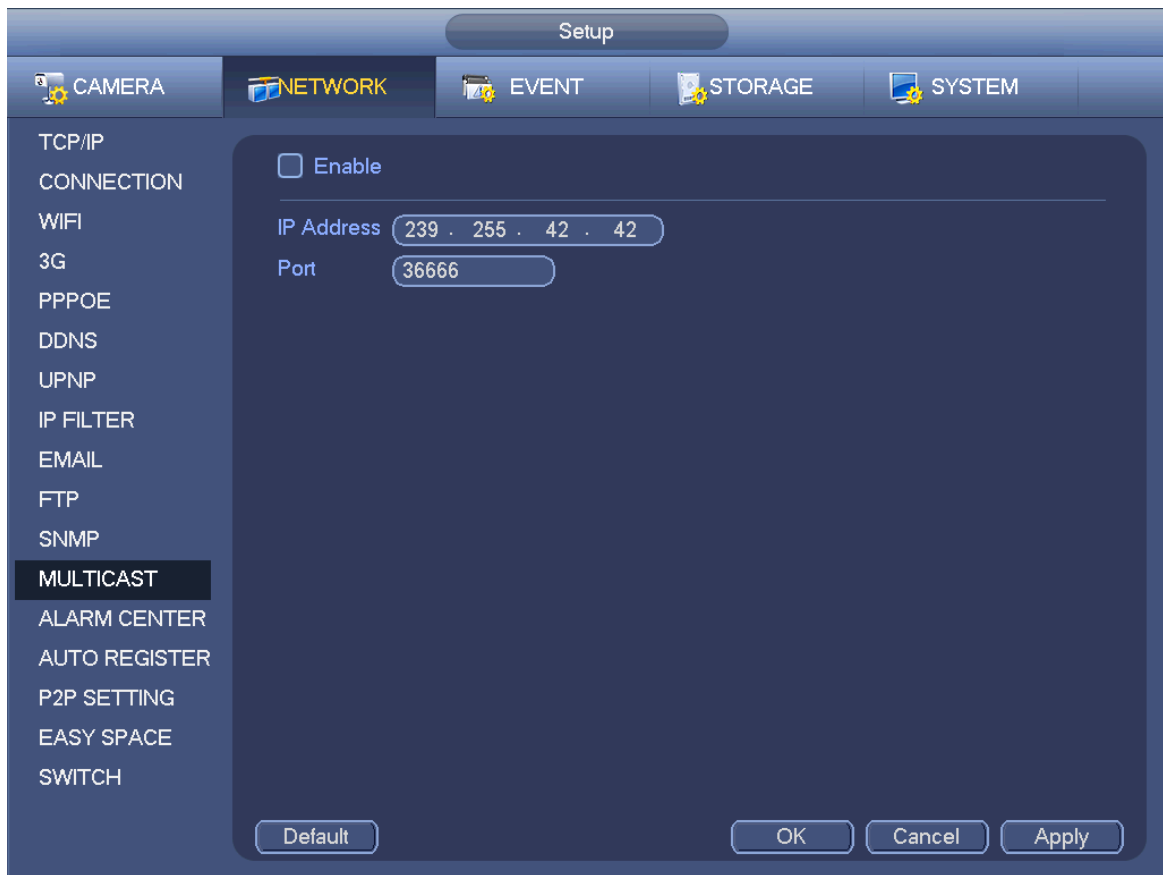

Figure 4-138

Here you can set a multiple cast group. Please refer to the following sheet for detailed information.

- IP multiple cast group address
 - 224.0.0.0-239.255.255.255
 - “D” address space
 - The higher four-bit of the first byte=“1110”
- Reserved local multiple cast group address
 - 224.0.0.0-224.0.0.255
 - TTL=1 When sending out telegraph
 - For example
 - 224.0.0.1 All systems in the sub-net
 - 224.0.0.2 All routers in the sub-net
 - 224.0.0.4 DVMRP router
 - 224.0.0.5 OSPF router
 - 224.0.0.13 PIMv2 router
- Administrative scoped addressees
 - 239.0.0.0-239.255.255.255
 - Private address space
 - Like the single broadcast address of RFC1918
 - Can not be used in Internet transmission
 - Used for multiple cast broadcast in limited space.

Except the above mentioned addresses of special meaning, you can use other addresses. For example:

Multiple cast IP: 235.8.8.36

Multiple cast PORT: 3666.

After you logged in the Web, the Web can automatically get multiple cast address and add it to the multiple cast groups. You can enable real-time monitor function to view the view.

Please note multiple cast function applies to special series only.

4.14.1.14 Alarm Centre

This interface is reserved for you to develop. See Figure 4-139.



Figure 4-139

4.14.1.15 Auto register

This function allows the device to auto register to the proxy you specified. In this way, you can use the client-end to access the NVR and etc via the proxy. Here the proxy has a switch function. In the network service, device supports the server address of IPv4 or domain.

Please follow the steps listed below to use this function.

Please set proxy server address, port, and sub-device name at the device-end. Please enable the auto register function, the device can auto register to the proxy server.

1) The setup interface is shown as in Figure 4-140.

Important

Do not input network default port such as TCP port number.



Figure 4-140

- 2) The proxy server software developed from the SDK. Please open the software and input the global setup. Please make sure the auto connection port here is the same as the port you set in the previous step.
- 3) Now you can add device. Please do not input default port number such as the TCP port in the mapping port number. The device ID here shall be the same with the ID you input in Figure 4-140. Click Add button to complete the setup.
- 4) Now you can boot up the proxy server. When you see the network status is Y, it means your registration is OK. You can view the proxy server when the device is online.

Important

The server IP address can also be domain. But you need to register a domain name before you run proxy device server.

4.14.1.16 P2P

You can use your cell phone to scan the QR code and add it to the cell phone client.

Via the SN from scanning the QR code, you can access the device in the WAN. Please refer to the P2P operation manual included in the resources CD.



From main menu->Setting->Network->P2P, you can go to the following interface, the P2P interface is shown as in Figure 4-141.



Figure 4-141

- Android:
Open Google Play app in your smart phone. Search gDMSS Lite or gDMSS Plus, download it and install.
- iOS:
Open App Store app in your smart phone. Search iDMSS Lite or iDMSS Plus, download it and install.

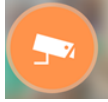
Please follow the steps listed below.

- Open App; tap  to go to the Liv preview.
 - Tap  at the top left corner, you can see the main menu.
 - Tap Device manager button, you can use several modes (P2P/DDNS/IP and etc) to add the device.
- Click  to save current setup. Tap Start Live preview to view all-channel video from the connected device. See Figure 4-142.

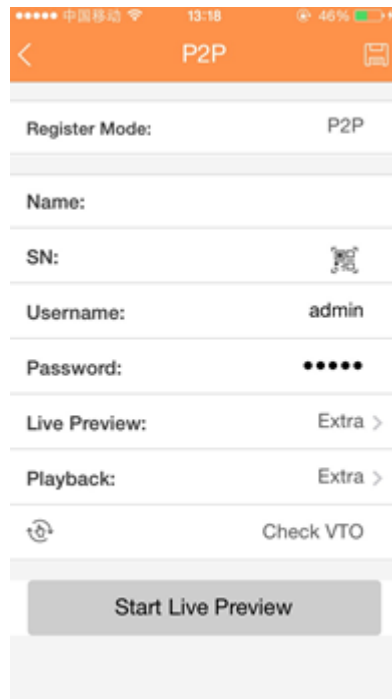

Figure 4-142

4.14.1.17 Easy Space

This function allows you to upload motion detect record or snapshot image to the dropbox and etc. The easy space interface is shown as below. See Figure 4-143.

Please select the easy space address from the dropdown list and then input corresponding user name and password.



Figure 4-143

Note:

- The uploaded file is for sub stream only. Please go to record control interface (main stream->setting->Storage->Record) and then select sub stream.
- The easy space function uses upload bandwidth. Usually the recommended upload bandwidth shall be more than 512kbps and please make sure the network is stable.
- The easy space upload data adopts safe SSL encryption connection. Please enable 1-channel to upload in case this function occupies too much CPU.

4.14.1.18 SWITCH

It is for you to set IP address, subnet mask, gateway and etc of the Switch. See Figure 4-144.



Figure 4-144

4.14.2 Network Test

In this interface, you can see network test and network load information.

4.14.2.1 Network Test

From main menu->Info-Network->Test, the network test interface is shown as in Figure 4-145.

- Destination IP: Please input valid IPV4 address and domain name.
- Test: Click it to test the connection with the destination IP address. The test results can display average delay and packet loss rate and you can also view the network status as OK, bad, no connection and etc.
- Network Sniffer backup: Please insert USB2.0 device and click the Refresh button, you can view the device on the following column. You can use the dropdown list to select peripheral device. Click Browse button to select the snap path. The steps here are same as preview backup operation.

You can view all connected network adapter names (including Ethernet, PPPoE, WIFI, and 3G), you can click the button  on the right panel to begin Sniffer. Click the grey stop button to stop. Please note system can not Sniffer several network adapters at the same time.

After Sniffer began, you can exit to implement corresponding network operation such as login WEB, monitor. Please go back to Sniffer interface to click  stop Sniffer. System can save the packets to the specified path. The file is named after "Network adapter name+time". You can use software such as Wireshark to open the packets on the PC for the professional engineer to solve complicated problems.

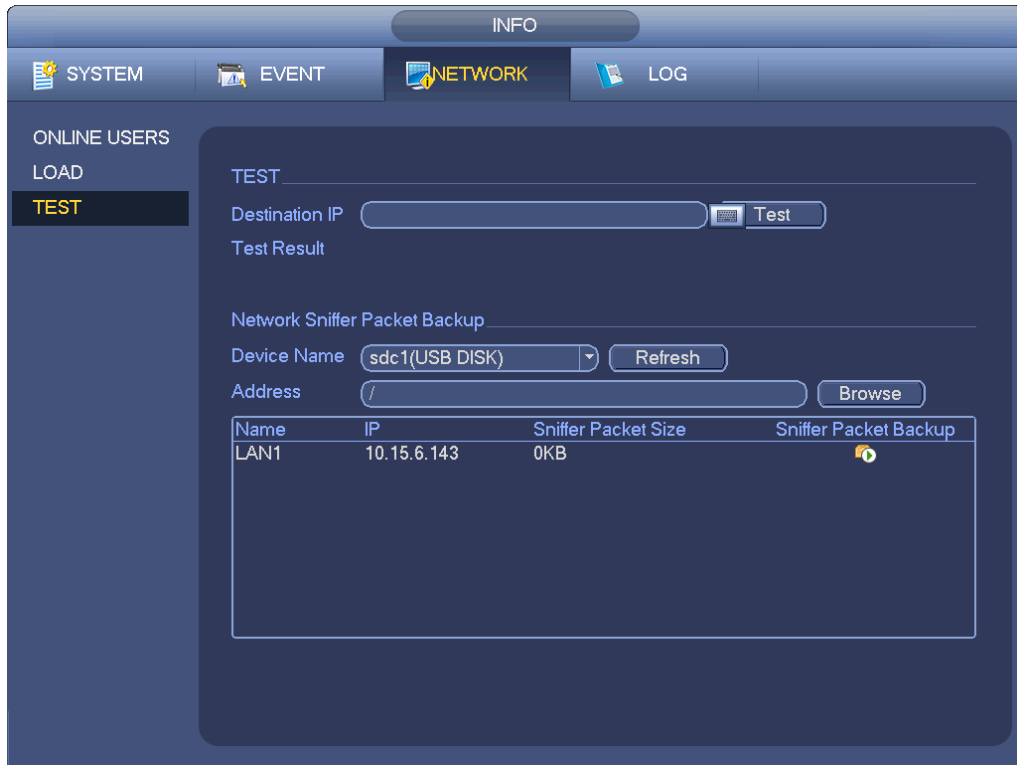

Figure 4-145

4.14.2.2 Network Load

From main menu->Info-Network->Load, network load is shown as in Figure 4-146. Here you can view the follow statistics of the device network adapter.

Here you can view information of all connected network adapters. The connection status is shown as offline if connection is disconnected. Click one network adapter, you can view the flow statistics such as send rate and receive rate at the top panel

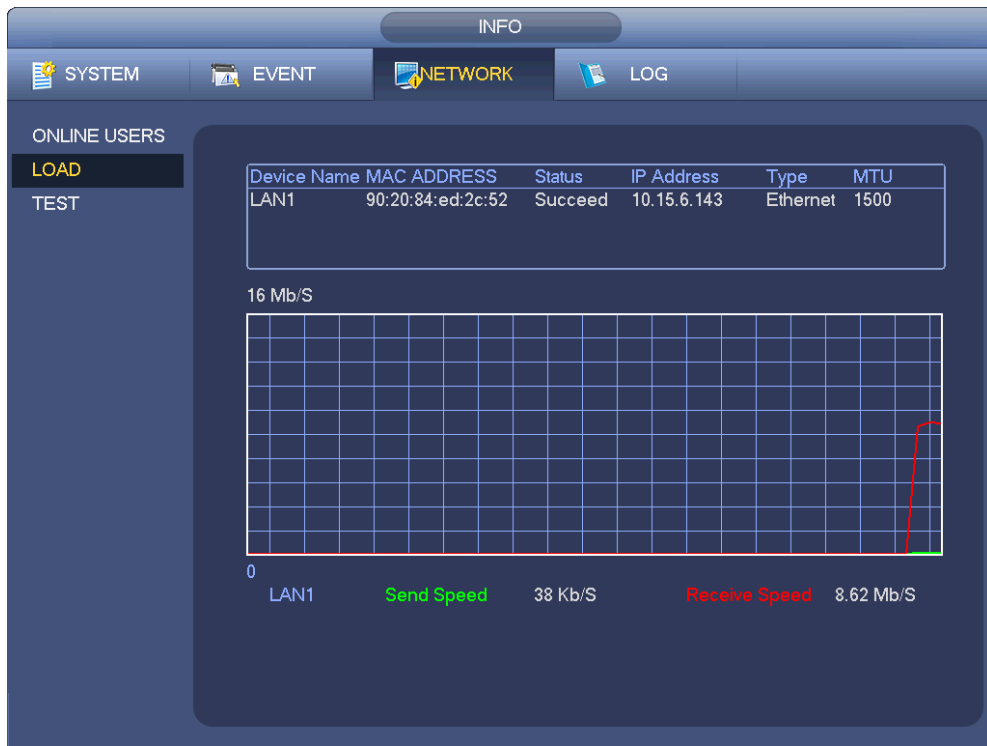

Figure 4-146

4.15 HDD Setup

Here you can view HDD information such as type, status, total capacity, record time and etc. The operation includes format, resume from error, change HDD property (Read write, Read-only). Here you can also set alarm and HDD storage position.

4.15.1 Format

- From Mani-menu->Setting->Storage->HDD Manager, you can go to HDD management interface. See Figure 4-147.



Figure 4-147

b) Select a HDD and then select format from the dropdown list. Click Execute button.

c) Click OK button to complete the setup. You can see system needs to restart to activate current setup.

4.15.2 HDD Information

Here is to list hard disk type, total space, free space, and status. See Figure 4-148.

○ means current HDD is normal.. - means there is no HDD.

If disk is damaged, system shows as “?”. Please remove the broken hard disk before you add a new one.

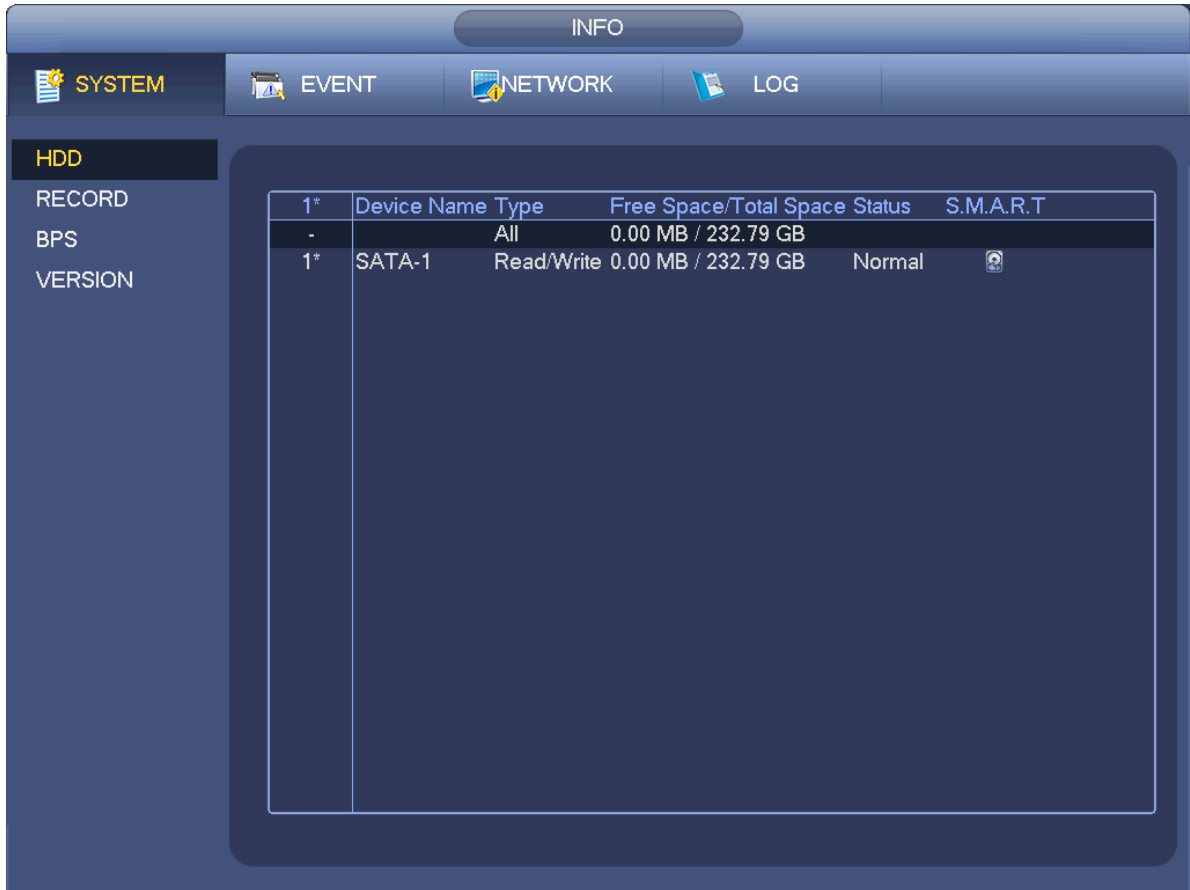

Figure 4-148

In Figure 4-148, click one HDD item, the S.M.A.R.T interface is shown as in Figure 4-149.



Figure 4-149

Parameter	Function
SATA	1 here means there is 1 HDD. For different series product, the max HDD amount may vary, When HDD is working properly, system is shown as O. . “_” means there is no HDD.
SN	You can view the HDD amount the device connected to; * means the second HDD is current working HDD.
Type	The corresponding HDD property.
Total space	The HDD total capacity.
Free space	The HDD free capacity.
Status	HDD can work properly or not.
Bad track	Display there is bad track or not.
Page up	Click it to view previous page.
Page down	Click it to view the next page.
View recording time	Click it to view HDD record information (file start time and end time).
View HDD type and capability	Click it to view HDD property, status and etc,

4.15.3 Advanced

It is to set HDD group, and HDD group setup for main stream, sub stream and snapshot operation

Important

HDD group and quota mode can not be valid at the same time. System needs to restart once you change the mode here.

The HDD group mode is shown as in Figure 4-150.

- HDD: Here you can view the HDD amount the device can support.
- Group: It lists the HDD Group number of current hard disk.

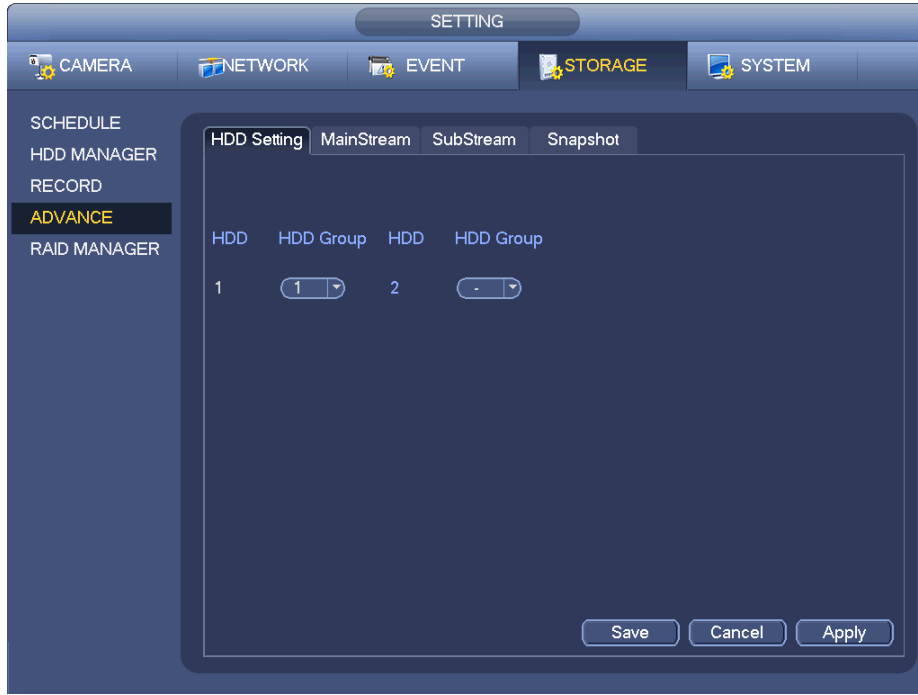

Figure 4-150

Please select the correspond group from the dropdown list and then click Apply button. Click main stream/sub stream/snapshot button to set corresponding HDD group information. See Figure 4-151 through Figure 4-153.



Figure 4-151



Figure 4-152



Figure 4-153

4.15.4 HDD Detect

Note

This function is for some series product only.

The HDD detect function is to detect HDD current status so that you can clearly understand the HDD performance and replace the malfunction HDD.

There are two detect types:

- Quick detect is to detect via the universal system files. System can quickly complete the HDD scan. If you want to use this function, please make sure the HDD is in use now. If the HDD is removed from other device, please make sure the write-data once was full after it installed on current device.
- Global detect adopts Windows mode to scan. It may take a long time and may affect the HDD that is recording.

4.15.4.1 Manual Detect

From main menu->Setting->Storage->HDD Detect->Manual Detect, the interface is shown as below. See Figure 4-154.

Please select detect type and HDD. Click start detect to begin. You can view the corresponding detect information.

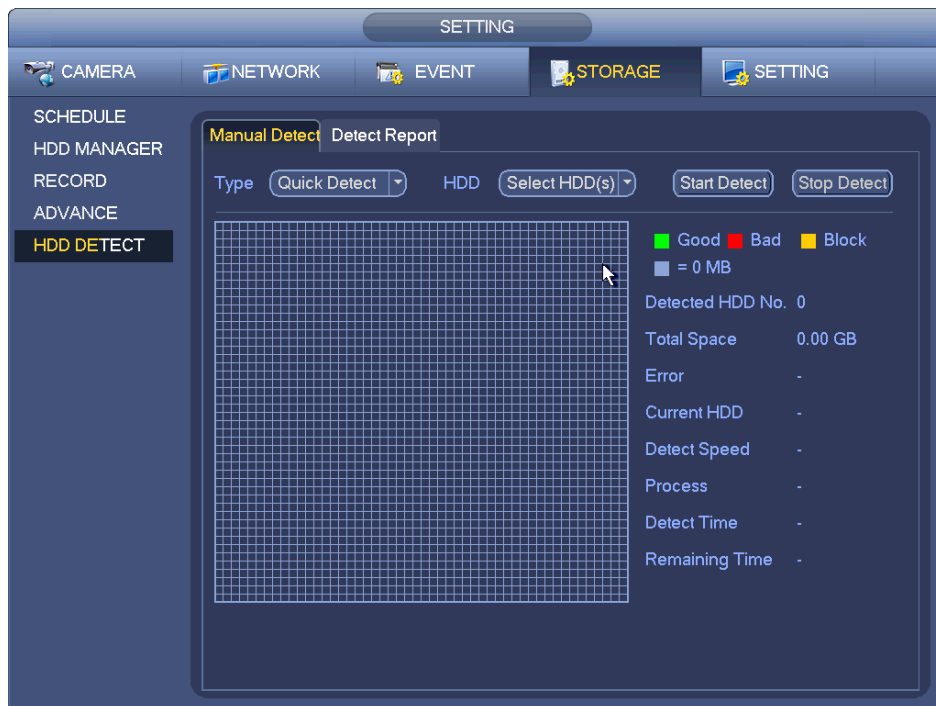

Figure 4-154

4.15.4.2 Detect Report

After the detect operation, you can go to the detect report to view corresponding information.

From main menu->Setting->Storage->HDD Detect->Manual Detect, the interface is shown as below. See Figure 4-155.

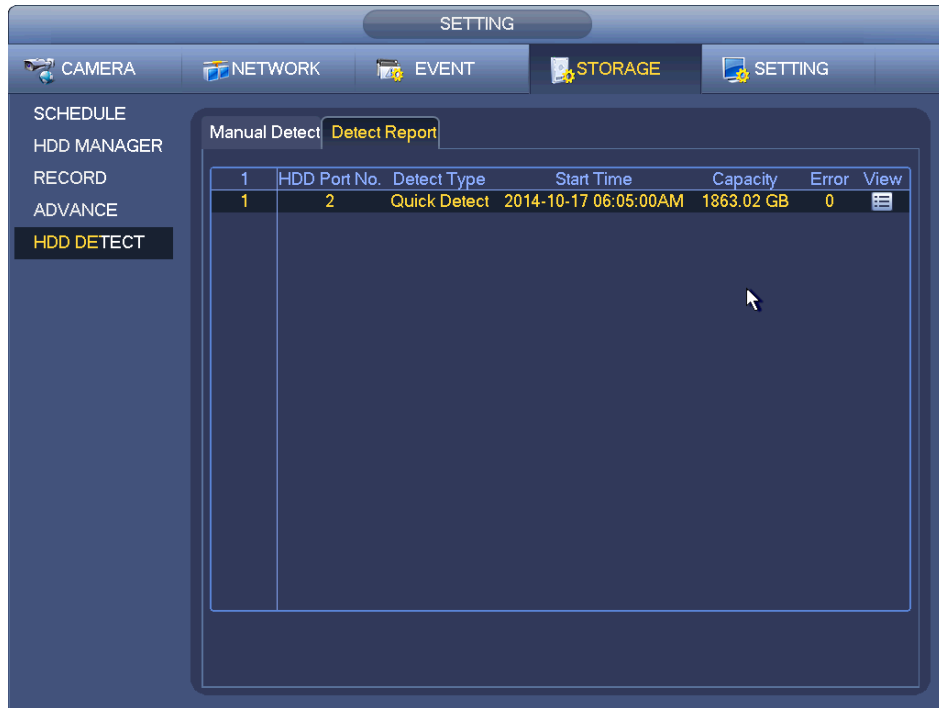

Figure 4-155

Click View, you can see the detailed information such as detect result, backup and S.M.A.R.T. See Figure 4-156 and Figure 4-157.



Figure 4-156

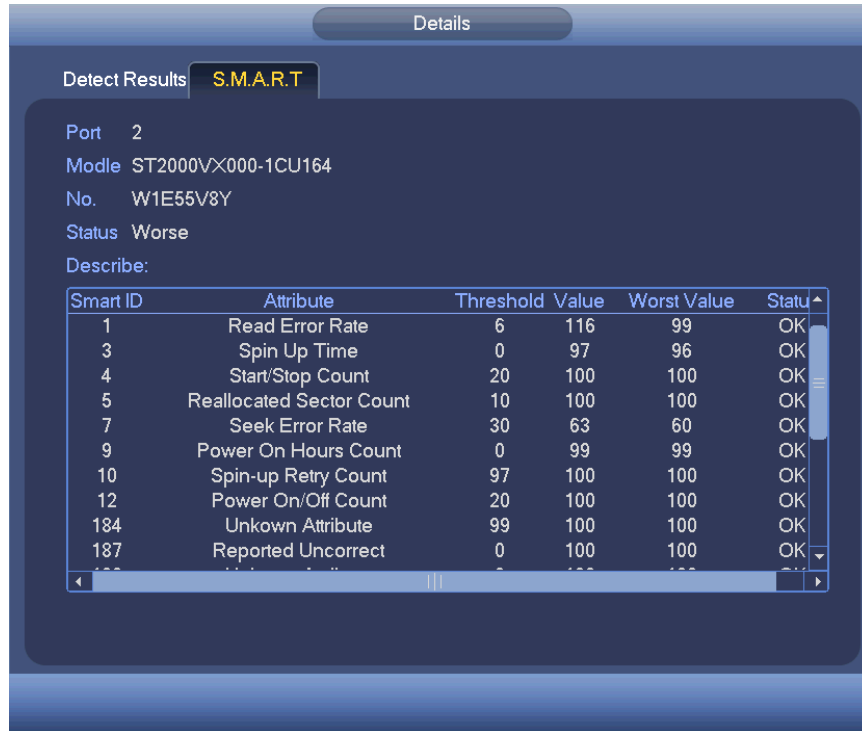

Figure 4-157

4.15.5 RAID Manager

Important

Please make sure your purchased product support the RAID function, otherwise you can not see the following interface.

Right now, RAID supports Raid0, Raid1, Raid5, Raid6, and Raid10. Local hotspare supports Raid1, Raid5, Raid6, and Raid10.

4.15.5.1 RAID Config

It is for you to manage RAID HDD. It can display RAID name, type, free space, total space, status and etc. Here you can add/delete RAID HDD.

Click Add button to select RAID type and then select HDDs, click OK button to add. See Figure 4-158.

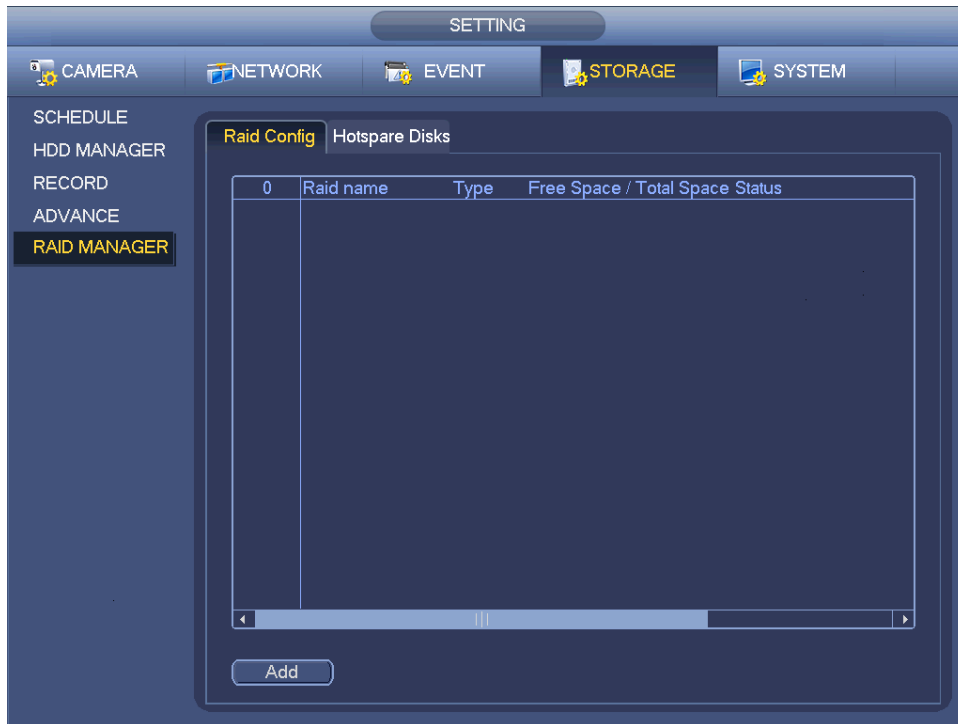

Figure 4-158

4.15.5.2 Hotspare disks

Click Hotspare disks tab name, you can add the hot spare HDD. See Figure 4-159. The type includes two options:

- Global: It is global hotspare disk. When any RAID becomes degrading, it can replace and build the RAID.
- Local: It is local hotspare disk. When the specified RAID becomes degrading, it can replace and build the RAID.

Select a hot spare device and then click Delete button. Click Apply button to delete.



Figure 4-159

4.16 Basic Setups

Set NVR basic setup, device setup and other setups.

4.16.1 Device Setup

From Main menu->Setting->System->General, you can go to the general interface. See Figure 4-161.

- Pack duration: Here is for you to specify record duration. The value ranges from 0 to 120 minutes. Default value is 60 minutes.
- Device ID: Please input a corresponding device name here.
- Device No: When you are using one remote control (not included in the accessory bag) to control several NVRs, you can give a name to each NVR for your management.
- Language: System supports various languages: Chinese (simplified), Chinese (Traditional), English, Italian, Japanese, French, Spanish (All languages listed here are optional. Slight difference maybe found in various series.)
- Video standard: There are two formats: NTSC and PAL.
- HDD full: Here is for you to select working mode when hard disk is full. There are two options: stop recording or rewrite. If current working HDD is overwritten or the current HDD is full while the next HDD is no empty, then system stops recording, If the current HDD is full and then next HDD is not empty, then system overwrites the previous files.
- Pack duration: Here is for you to specify record duration. The value ranges from 1 to 120 minutes. Default value is 60 minutes.
- Realtime play: It is to set playback time you can view in the preview interface. The value ranges from 5 to 60 minutes.
- Auto logout: Here is for you to set auto logout interval once login user remains inactive for a specified time. Value ranges from 0 to 60 minutes.
- Navigation bar: Check the box here, system displays the navigation bar on the interface.

- IPC Time Sync: You can input an interval here to synchronize the NVR time and IPC time.
- Startup wizard: Once you check the box here, system will go to the startup wizard directly when the system restarts the next time. Otherwise, it will go to the login interface.
- Mouse sensitivity: You can set double click speed via dragging the slide bard. You can Click Default button to restore default setup.
- Enable IVS: Check the box to enable IVS function, system can display IVS rule on the preview interface.



Figure 4-160

4.16.2 Data and Time

From Main menu->Setting->System->General, you can go to the general interface. See Figure 4-161.

- System time: Here is for you to set system time
- Date format: There are three types: YYYY-MM-DD: MM-DD-YYYY or DD-MM-YYYY.
- Date separator: There are three denotations to separate date: dot, beeline and solidus.
- DST: Here you can set DST time and date by week or by date. Please enable DST function and then select setup mode. Please input start time and end time and click Save button.
- Time format: There are two types: 24-hour mode or 12-hour mode.
- NTP: It is to set NTP server, port and interval.

Note:

Since system time is very important, do not modify time casually unless there is a must!

Before your time modification, please stop record operation first!

After completing all the setups please click save button, system goes back to the previous menu.

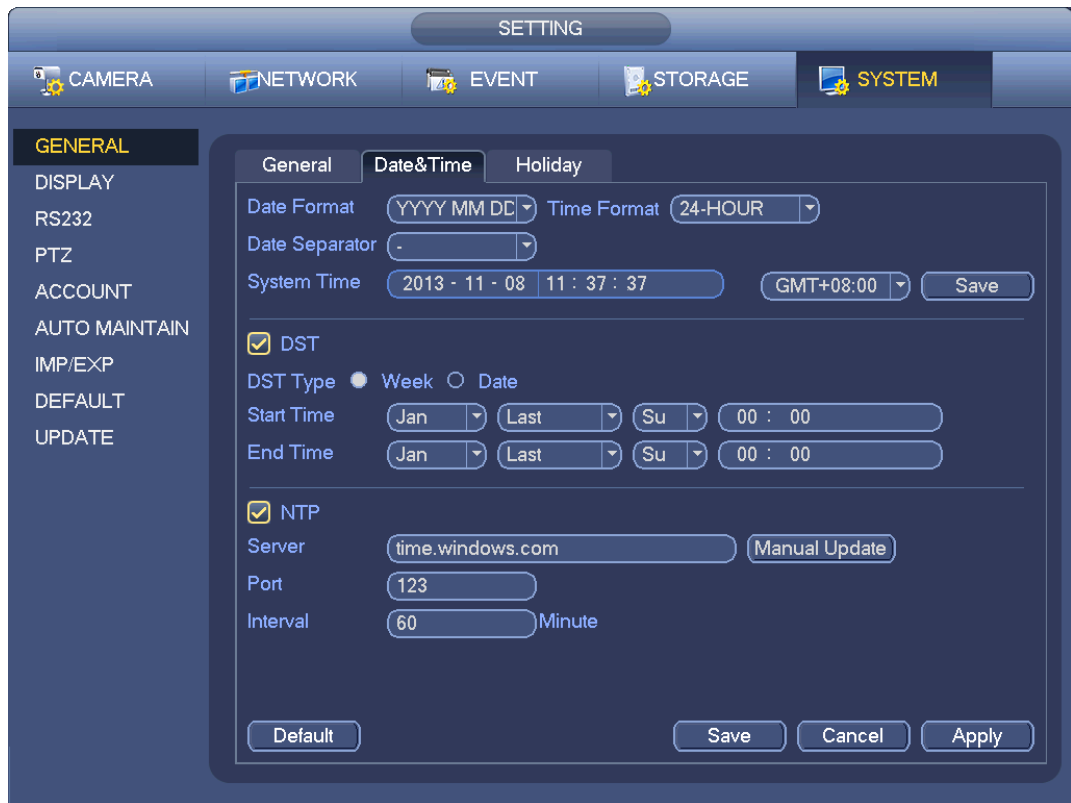

Figure 4-161

4.16.3 Holiday

Please refer to chapter 4.10.6 for detailed information.

4.17 Device Maintenance and Manager

4.17.1 System Info

4.17.1.1 Version

From main menu->Info->System->version, you can go to version interface.

Here is for you to view some version information. See Figure 4-162. **Please note the following figure for reference only.**

- Channel
- Alarm in
- Alarm out
- System version
- Build Date
- Web
- Serial number



Figure 4-162

4.17.1.2 BPS

Here is for you to view current video bit rate (kb/s) and resolution. See Figure 4-163.

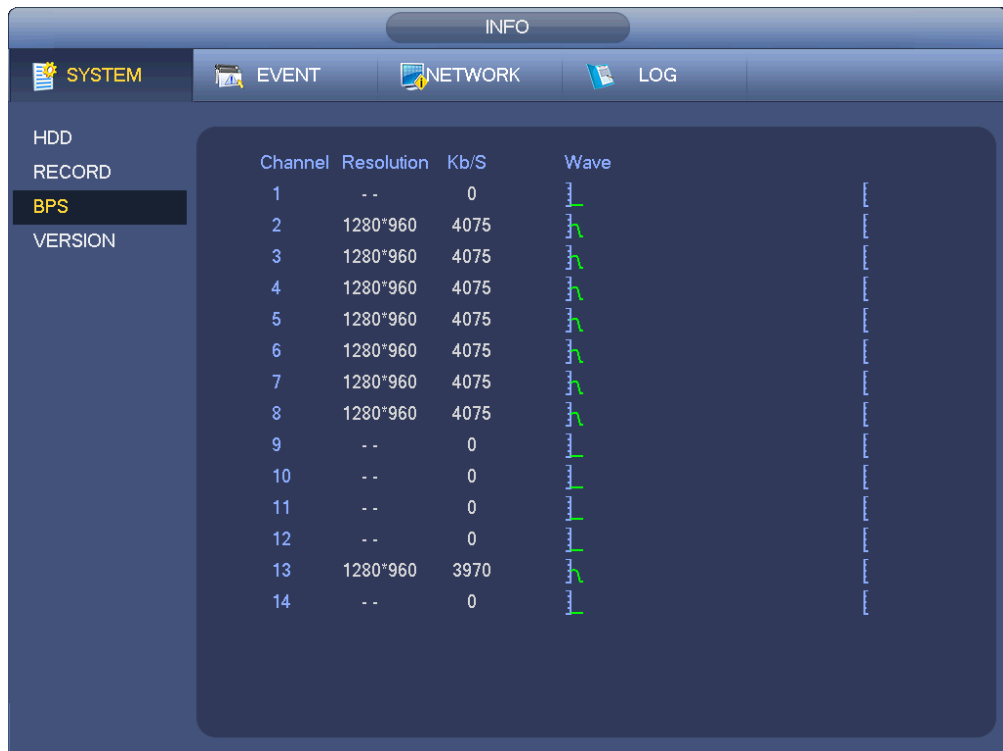

Figure 4-163

4.17.1.3 Online User

Here is for you manage online users connected to your NVR. See Figure 4-164.

You can click button  to disconnect or block one user if you have proper system right.

System detects there is any newly added or deleted user in each five seconds and refresh the list automatically.

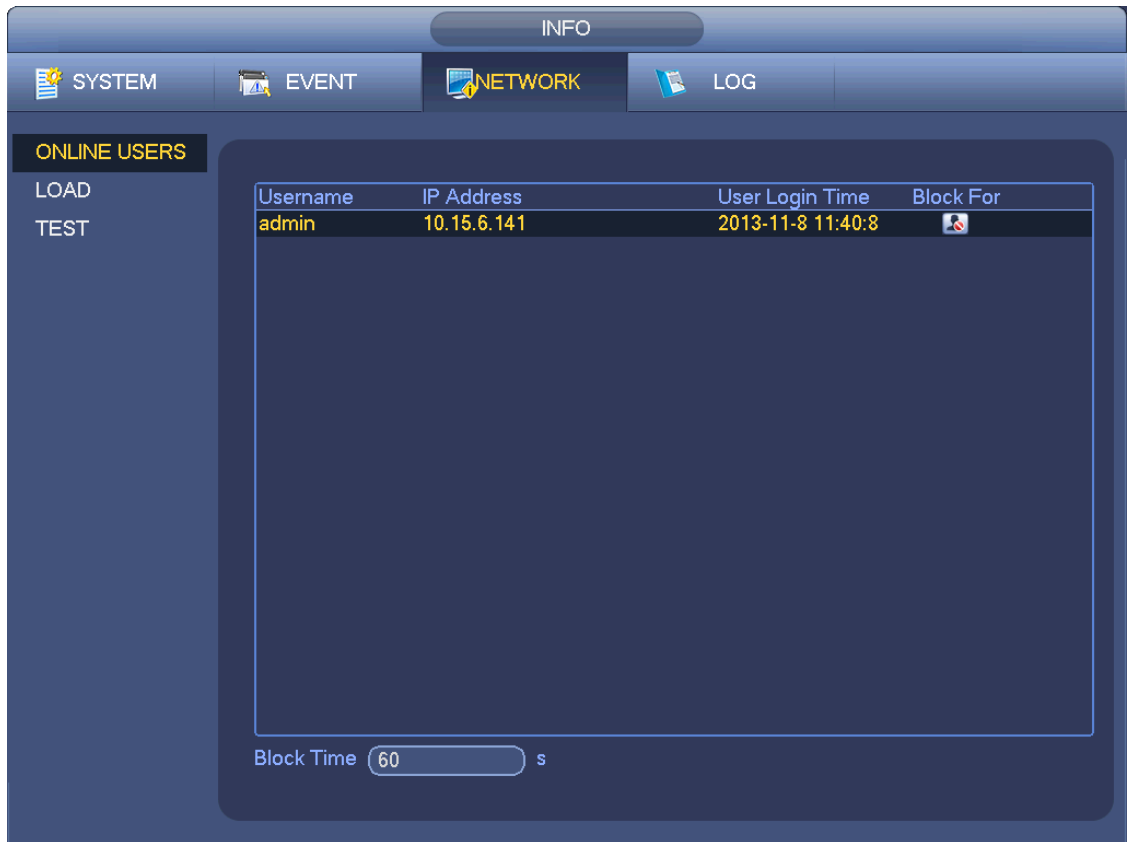

Figure 4-164

4.17.1.4 Remote Device Information

From main menu->info-Event, here you can view the channel status of the remote device, connection log and etc. See Figure 4-165.



Figure 4-165

4.17.1.5 Remote

4.17.1.5.1 Device Status

Here you can view the IPC status of the corresponding channel such as motion detect, video loss, tampering, alarm and etc. See Figure 4-166.

- IPC status: : Front-end does not support. : Front-end supports. : There is alarm event from current front-end.
- Connection status: : Connection succeeded. : Connection failed.
- Refresh: Click it to get latest front-end channel status.



Figure 4-166

4.17.1.5.2 Firmware

It is to view channel, IP address, manufacturer, type, system version, SN, video input, audio input, external alarm and etc. See Figure 4-167.

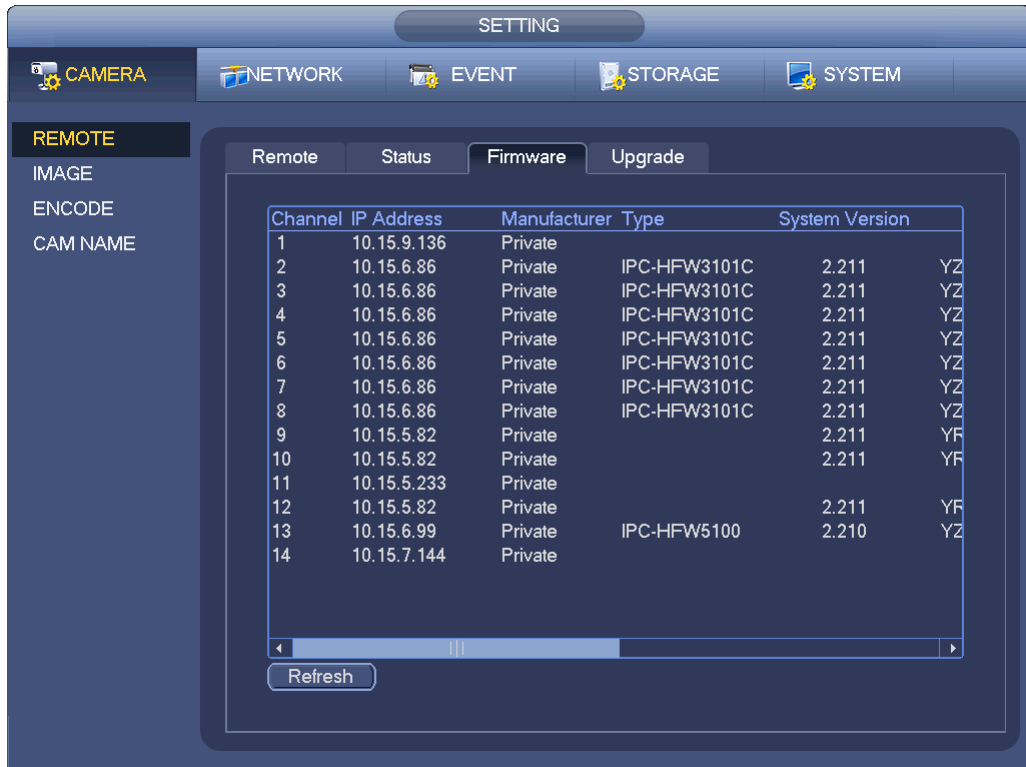

Figure 4-167

4.17.2 Log

From Main menu->Info->Log, you can go to the following interface. See Figure 4-168.

- Start time/end time: Pleased select start time and end time, then click search button. You can view the log files in a list. System max displays 100 logs in one page. It can max save 1024 log files.

Please use page up/down button on the interface or the front panel to view more.

Tips

Double click a log item to view its detailed information. See Figure 4-169.

Click PgUp/PgDn to view more logs.



Figure 4-168

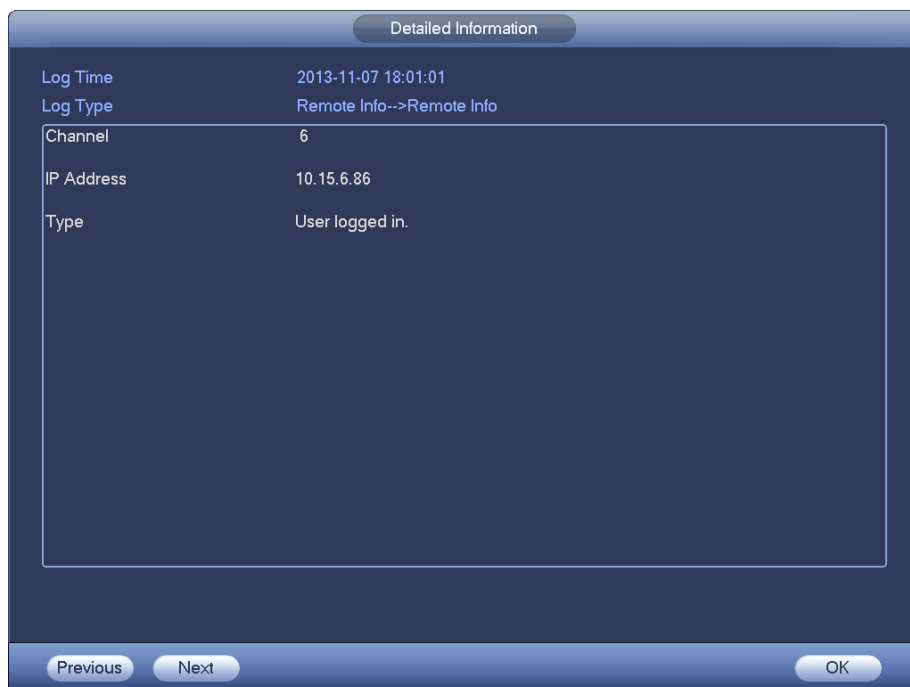

Figure 4-169

4.17.3 Voice

Note

This function is for some series product only.

The audio function is to manage audio files and set schedule play function. It is to realize audio broadcast activation function.

4.17.3.1.1 File Manage

Here you can add audio file, listen to the audio file, or rename/delete audio file. Here you can also set audio volume. See Figure 4-170.



Figure 4-170

Click Add button, you can add audio file and import the audio file via the USB device. The audio file format shall be MP3 or PCM. See Figure 4-171.



Important

The audio file shall be saved on the USB device. You need to connect the USB device all the time; otherwise, the audio link function may fail. So, if you want to use the audio trigger function, please make sure the audio file is on the UBS device and the USB device has connected to the NVR before the NVR boots up. You need to make sure the USB device connection is always there if you want to manage and use the audio file function.



Figure 4-171

4.17.3.1.2 Schedule

It is to set schedule broadcast function. You can play the different audio files in the specified periods. See Figure 4-172.



Figure 4-172

4.17.4 Account

Here is for you to implement account management. See Figure 4-173. Here you can:

- Add new user

- Modify user
- Add group
- Modify group
- Modify password.

For account management please note:

- For the user account name and the user group, the string max length is 6-byte. The backspace in front of or at the back of the string is invalid. There can be backspace in the middle. The string includes the valid character, letter, number, underline, subtraction sign, and dot.
- The default user amount is 64 and the default group amount is 20. System account adopts two-level management: group and user. No limit to group or user amount.
- For group or user management, there are two levels: admin and user.
- The user name and group name can consist of eight bytes. One name can only be used once. There are three default users: admin/888888 and hidden user “default”.
- Hidden user “default” is for system interior use only and can not be deleted. When there is no login user, hidden user “default” automatically login. You can set some rights such as monitor for this user so that you can view some channel view without login.
- One user should belong to one group. User right can not exceed group right.
- About reusable function: this function allows multiple users use the same account to login.
- About user account and MAC. When you add a new user, you can input the MAC address of current user. Only the user of the same MAC address can access the device remotely.(MAC address is for the device of the same LAN.) If you leave MAC address item in blank when you add a new user, the user of any MAC address can access the device remotely. You can set or change MAC address when you add or modify a user. The MAC address function is also valid for PSS login. **Please note current function does not support IPV6.**

After all the setups please click save button, system goes back to the previous menu.



Figure 4-173

4.17.4.1.1 Add User

Click modify user button  in Figure 4-173 , the interface is shown as in Figure 4-174.

Please input the user name, password, select the group it belongs to from the dropdown list.

Then you can check the corresponding rights for current user.

For convenient user management, usually we recommend the general user right is lower than the admin account.

- **Username:** admin. **Password:** admin. (administrator, local and network)
- **Username:** 888888. **Password:** 888888. (administrator, local only)
- **Username:** default. **Password:** default (hidden user). Hidden user “default” is for system interior use only and can not be deleted. When there is no login user, hidden user “default” automatically login. You can set some rights such as monitor for this user so that you can view some channels without login.



Figure 4-174

When you create a new user, you can input the corresponding MAC address of current user. If you leave this item in blank, any MAC address user can share this user account to login. Please note system needs to check the validity of MAC. Only the 12-digit 0-f format address can pass the validity verification. System only saves small character even you input capitalized one. You can see the corresponding prompt if there is any illegal input.

Click the Set button after the period, you can set valid period to use current account. See Figure 4-175.

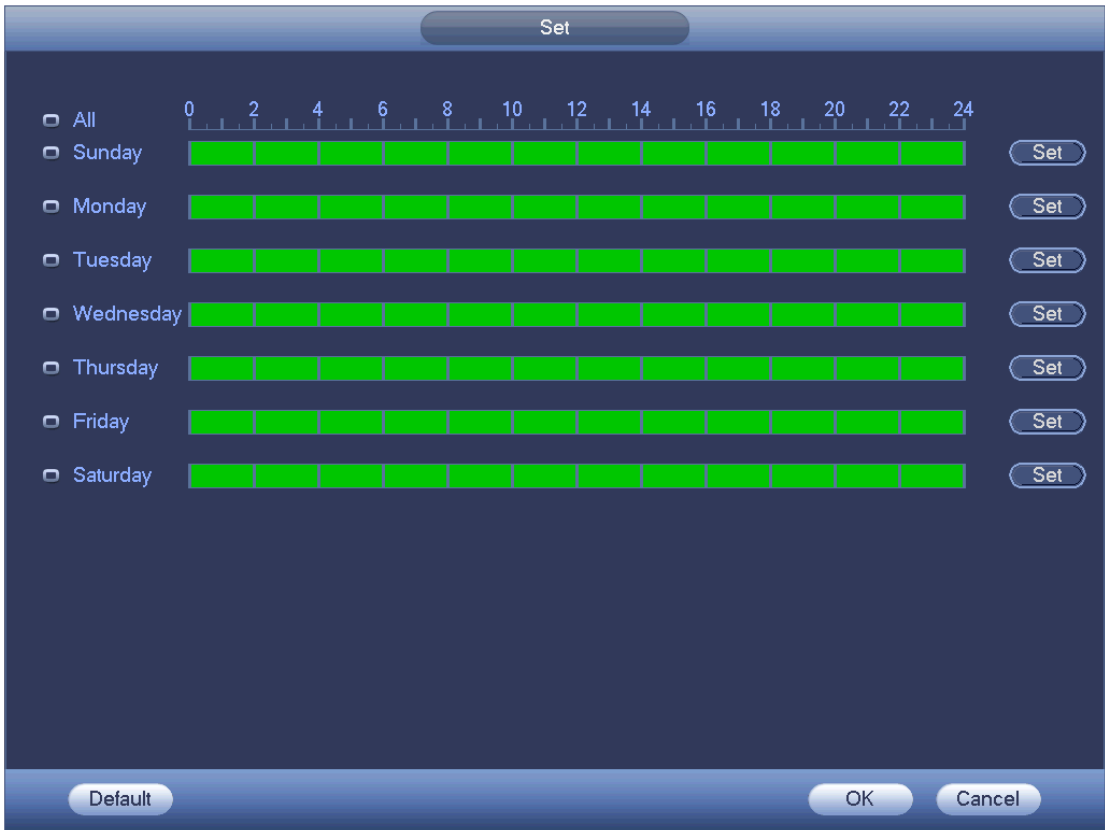



Figure 4-175

Click Set button, you can set six periods in one day. See Figure 4-176.
Check the box after the period, you can enable current setup.



Figure 4-176

4.17.4.1.2 Modify user

Click , you can go to the following interface to change user information. See Figure 4-177. For admin, 888888, and default (hidden user), you can not change period setup.

Modify User

User Name

Modify Password

Old Password

New Password

Confirm Password

User MAC

User Name

Group

Memo

Authority

System Playback Monitor

All

ACCOUNT SYSTEM DISCONNECT USER DEFAULT&UPGRADE

PTZ INFO MANUAL CONTROL BACKUP

COLOR STORAGE EVENT NETWORK

CAMERA CLEAR LOG SHUTDOWN

Save Cancel

Figure 4-177

4.17.4.1.3 Change Password

In Figure 4-177, check the Modify password box, you can change password. Please input old password, and then input new password twice to confirm.

The password can contain 32-byte and the space at the begin or at the end of the password are null. It can contain in the middle of the password. For the user of account right, it can change the password of other users.

4.17.4.1.4 Add/Modify Group

In Figure 4-173, click Group button, you can see the following interface. See Figure 4-178.



Figure 4-178

Click add group button in Figure 4-178 , the interface is shown as below. See Figure 4-179.

Here you can input group name and then input some memo information if necessary.

There are total 98 rights such as control panel, shut down, real-time monitor, playback, record, record file backup, PTZ, user account, system information view, alarm input/output setup, system setup, log view, clear log, upgrade system, control device and etc.



Figure 4-179

4.17.4.1.5 Security Question

The security question is shown as below. See Figure 4-180.
Here you can change security questions.

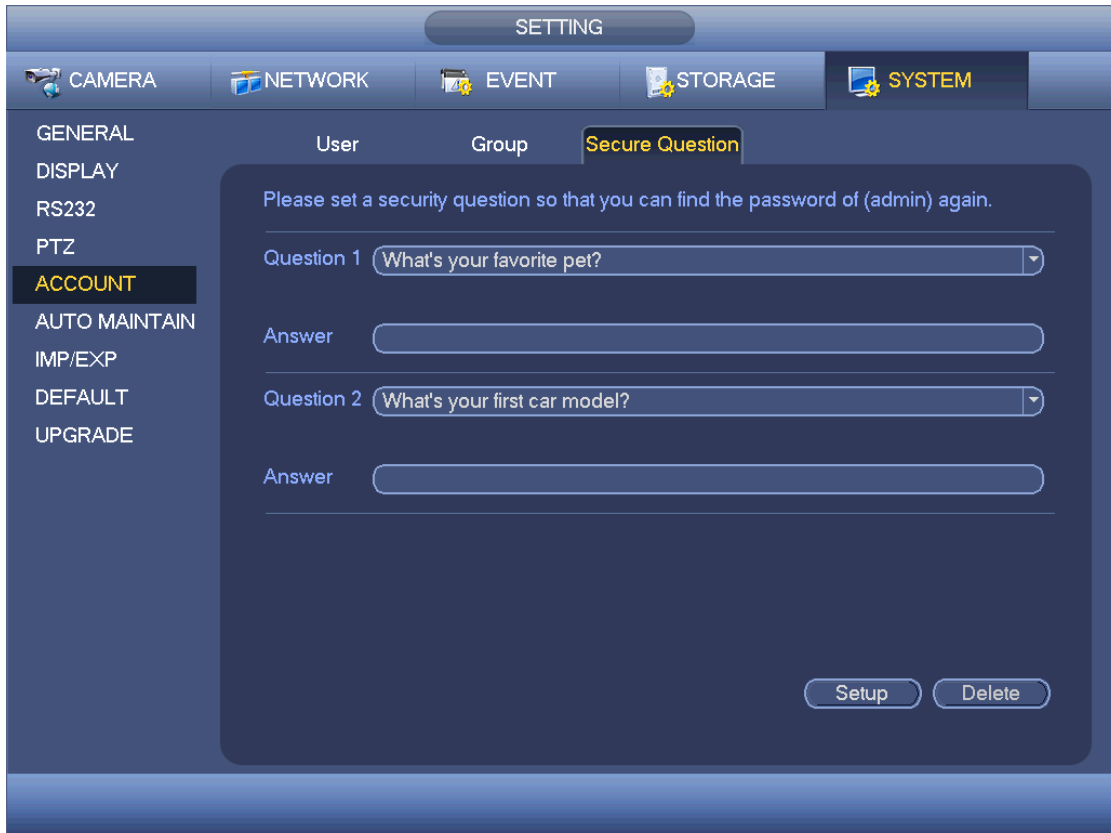

Figure 4-180

4.17.5 Update

4.17.5.1 Local Update

From Mani menu->Setting->Info->Update, you can go to the following interface. See Figure 4-181.

- a) Insert USB device that contain the upgrade file.
- b) Click Start button and then select the .bin file.
- c) You can see the corresponding dialogue box after the update process is complete.

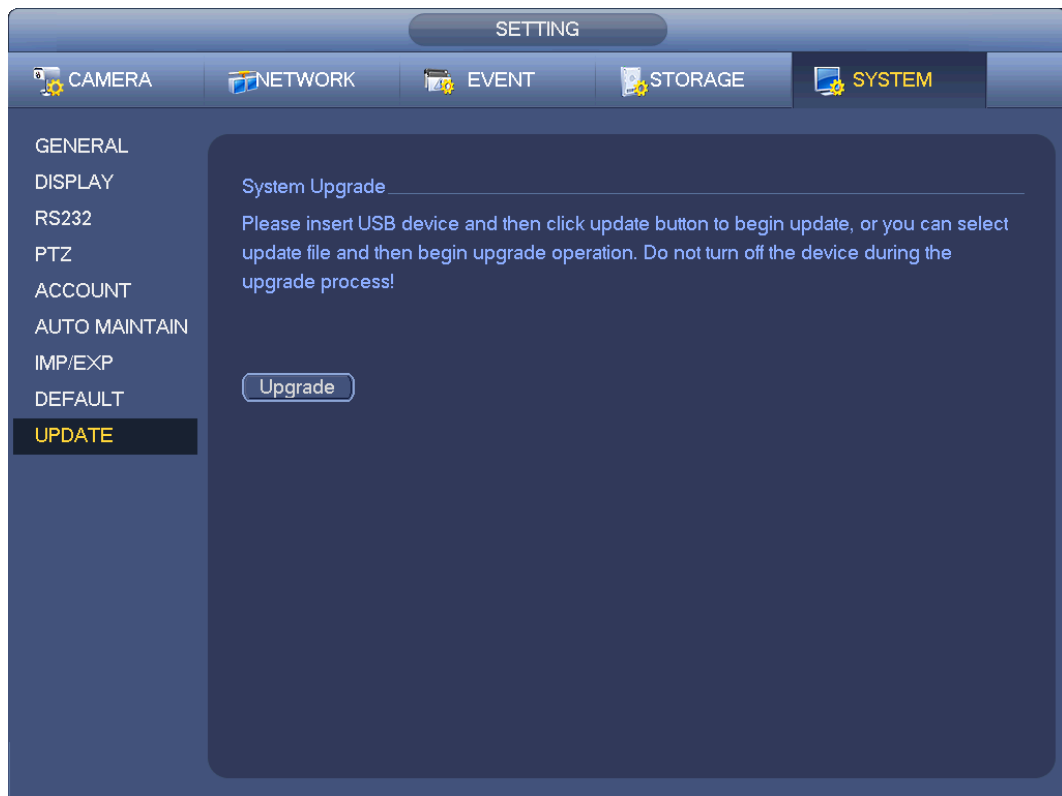

Figure 4-181

4.17.5.2 Uboot

When device is booting up, it can auto detect the USB device and the update file on it. It can auto update once there is proper upgrade file.



Important

- USB device root directory shall have “u-boot.bin.img” and “update.img” files. USB device shall be FAT32 mode.
- For 4X series product, it only updates “update.img”. The “update.img” shall be renamed as “recovery.img” and is saved on the root directory.
- USB device shall be on the USB 2.0 port, otherwise device can not detect or update.

4.17.6 Default

You can restore factory default setup to fix some problems when the device is running slowly. Configuration error occurred.

From Main menu->Setting->System->Default, you can go to the default interface. See Figure 4-182.

Click default icon, system pops up a dialogue box. You can highlight  to restore factory default setup.

- All
- Camera
- Network
- Event
- Storage
- System

Please highlight icon  to select the corresponding function.

After all the setups please click OK button, system goes back to the previous menu.

Warning!

After you use default function, some your customized setup may lose forever! Please think twice before you begin the operation!



Figure 4-182

4.17.7 RS232

From Main menu->Setting->System->RS232, RS232 interface is shown as below. There are five items. See Figure 4-183.

- Function: There are various devices for you to select. Console is for you to use the COM or mini-end software to upgrade or debug the program. The control keyboard is for you to control the device via the special keyboard. Transparent COM (adapter) is to connect to the PC to transfer data directly. Protocol COM is for card overlay function. Network keyboard is for you to use the special keyboard to control the device. PTZ matrix is to connect to the peripheral matrix control.
- Baud rate: You can select proper baud rate.
- Data bit: You can select proper data bit. The value ranges from 5 to 8.
- Stop bit: There are three values: 1/1.5/2.
- Parity: there are five choices: none/odd/even/space mark.

System default setup is:

- Function: Console
- Baud rate:115200
- Data bit:8
- Stop bit:1

- Parity: None

After completing all the setups please click save button, system goes back to the previous menu.



Figure 4-183

4.17.8 Auto Maintain

Here you can set auto-reboot time and auto-delete old files setup. You can set to delete the files for the specified days. See Figure 4-184.

You can select proper setup from dropdown list.

After all the setups please click save button, system goes back to the previous menu.

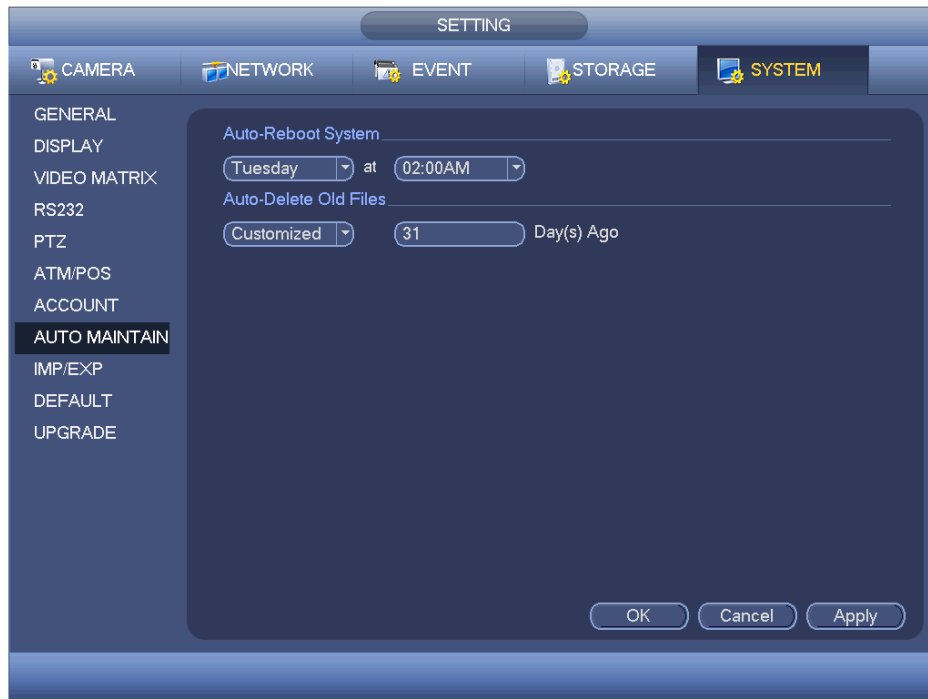

Figure 4-184

4.17.9 Logout /Shutdown/Restart

From Mani menu->Operation->Shutdown, you can see an interface shown as in Figure 4-185.

- Shutdown: System shuts down and turns off power.
- Logout: Log out menu. You need to input password when you login the next time.
- Restart: reboot device.

If you shut down the device, there is a process bar for your reference, system waits for 3 seconds and then shut down (You can not cancel).

Please note, sometimes you need to input the proper password to shut down the device.



Figure 4-185

5 Web Operation

5.1 General Introduction

The device web provides channel monitor menu tree, search, alarm setup, system setup, PTZ control and monitor window and etc.

Important

The following operation is based on 32-channel series device.

5.1.1 Preparation

Before log in, please make sure:

- Network connection is right
- NVR and PC network setup is right. Please refer to network setup(main menu->setting->network)
- Use order ping `***.***.***.***`(* NVR IP address) to check connection is OK or not. Usually the return TTL value should be less than 255.
- Open the IE and then input NVR IP address.
- System can automatically download latest web control and the new version can overwrite the previous one.

About PoE address setup, operation and allocation.

1) Insert PoE

After you insert PoE, device may try to set a corresponding IP address of the Switch network adapter. First, system tries to set via arp ping. It then uses DHCP if it finds the DHCP is enabled. After successfully set IP address, system may use Switch to send out broadcast, system considers the connection is OK when there is any response. Now system is trying to login the newly found IPC. Now please check the interface, you can see the corresponding digital channel is active now. You can see a small PoE icon at the top left corner. You can see the PoE channel, PoE port information and etc from the connection list of the registration interface (Chapter 5.8.1.1). For the IP search list, you need to click the IP search to display or refresh.

2) Remove PoE

After you removed PoE, you can see the corresponding digital channel becomes idle (disable). On the registration interface, it is removed from the connected list. For the IP search list, you need to click the IP search to refresh.

3) After you insert PoE, system follows the principles listed below to map channel.

- a) If it is your first time to insert PoE, system can map it to the first idle channel. After map, the channel can memorize the MAC address of the IPC. It is a `<Channel>---<IPC mac>` map. If current channel does not connect to other device, system can memorize current MAC address, otherwise it can refresh to the newly added device and memorize the `<PoE port>---<Channel>`.
- b) If it is your second time to insert the PoE, system can check the saved MAC address according to `<Channel>---<IPC mac>` map to make sure current IPC has connected or not. If system finds the previous information and the channel is idle, system can map it to the previously used channel. Otherwise system goes to the next step.

- c) Thirdly, according to the <PoE port>---<Channel> map, system can know the previous mapping channel of current PoE port. System can select current channel if it is free. Otherwise, it goes to the next step:
- d) Fourthly, system goes to find the first idle channel it can get.

Generally speaking, once you insert PoE, system follow the steps listed above to find the channel available.

- 4) When you insert PoE, all channels are in use now.

System can pop up a dialogue box for you to select a channel to overwrite. The title of the pop-up interface is the name of the current operation PoE port. In this interface, All PoE channel become grey and can not select.

5.1.2 Log in

Open the IE and then input the NVR IP address in the address column.

For example, if your NVR IP address is 192.168.1.108, then please input http:// 192.168.1.108 in IE address column. See Figure 5-1.

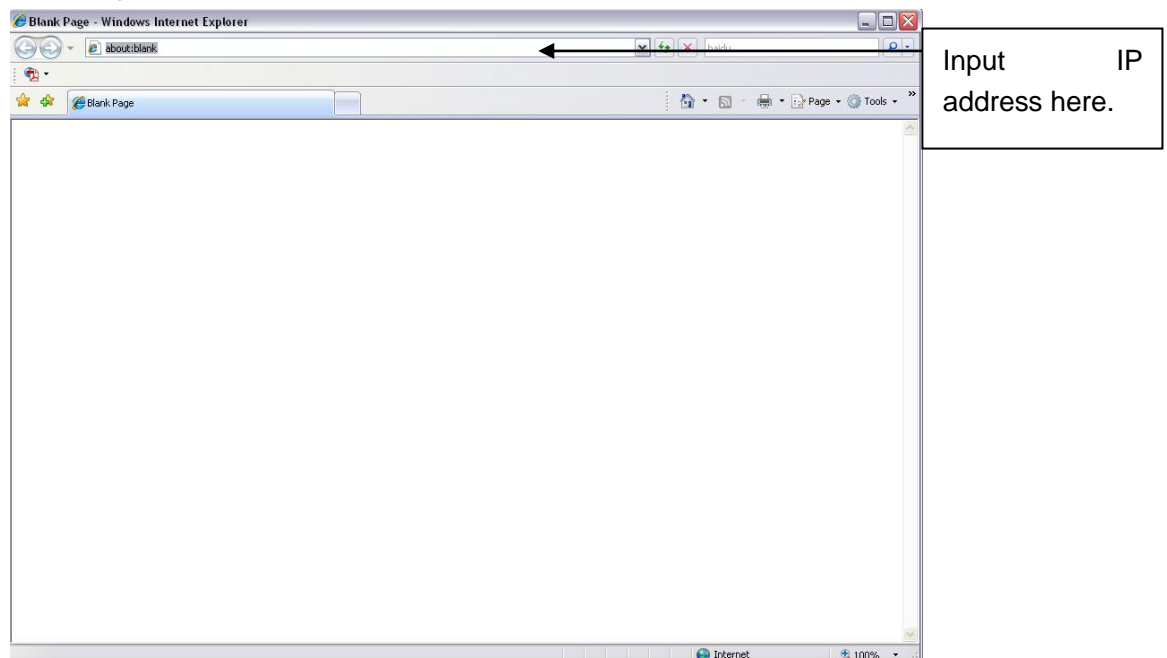

Figure 5-1

System pops up warning information to ask you whether install Web plug-in or not. Please click yes button.

If you can't download the ActiveX file, please modify your settings as follows. See Figure 5-2.

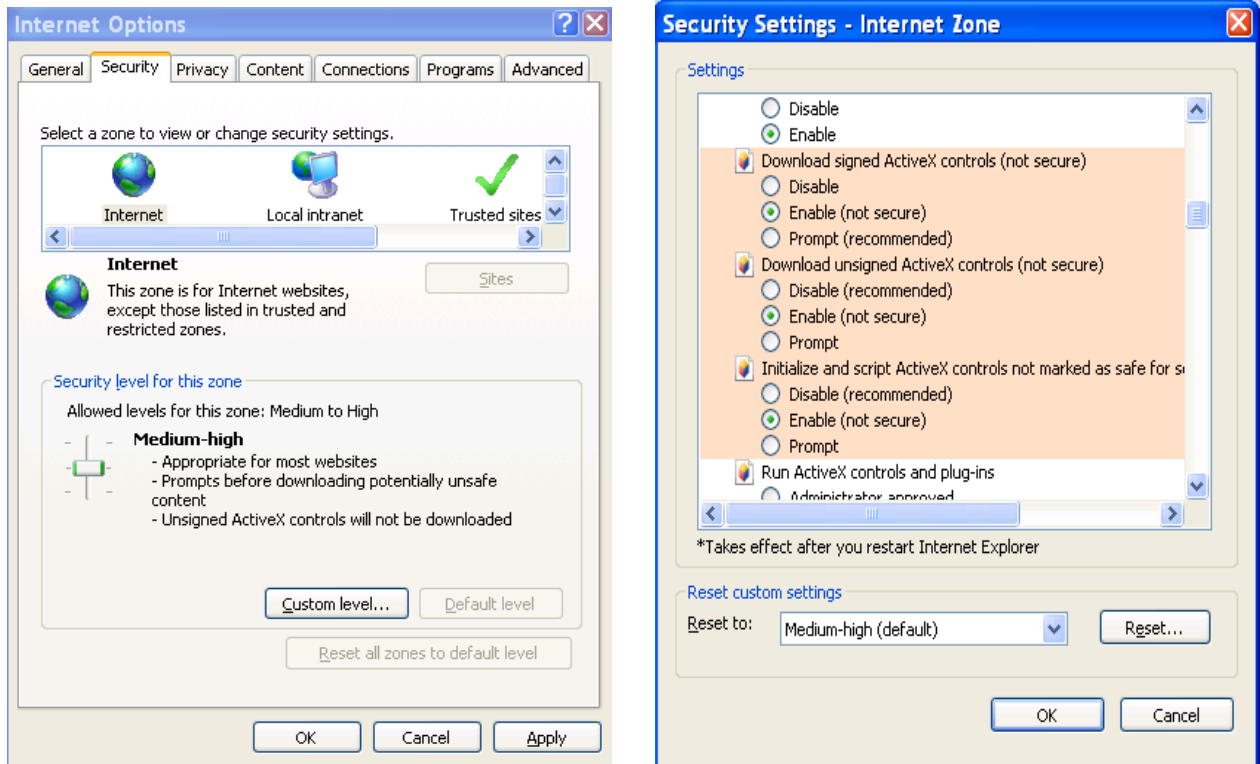

Figure 5-2

After installation, the interface is shown as below. See Figure 5-3.

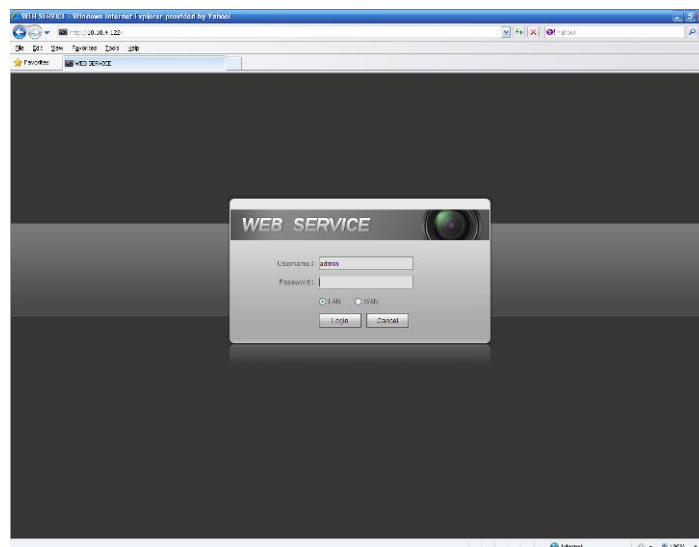

Figure 5-3

Please input your user name and password.

Default factory name is **admin** and password is **admin**.

Note: For security reasons, please modify your password after you first login.

5.2 LAN Mode

For the LAN mode, after you logged in, you can see the main window. See Figure 5-9.

This main window can be divided into the following sections.

- Section 1: there are six function buttons: Live (chapter 0) , setup (chapter 5.8), info (Chapter 5.9), playback (chapter 5.10), alarm (chapter 5.11), and logout (chapter 5.12).
- Section 2: There are monitor channels successfully connected to the NVR. Please refer to Figure 5-4 for main stream and extra stream switch information.

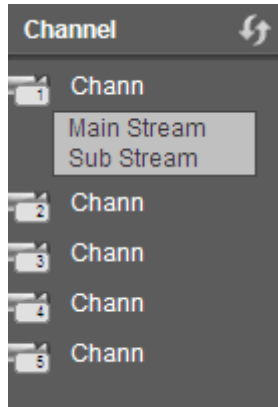

Figure 5-4

- Section 3: Open all. Open all button is to enable/disable all-channel real-time monitor. Here you can select main stream/sub stream too. See Figure 5-5.

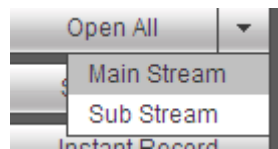

Figure 5-5

- Section 4: Start Talk button.

You can click this button to enable audio talk. Click 【▼】 to select bidirectional talk mode. There are four options: DEFAULT, G711a, G711u and PCM. See Figure 5-6.

After you enable the bidirectional talk, the Start talk button becomes End Talk button and it becomes yellow. Please note, if audio input port from the device to the client-end is using the first channel audio input port. During the bidirectional talk process, system will not encode the audio data from the 1-channel.

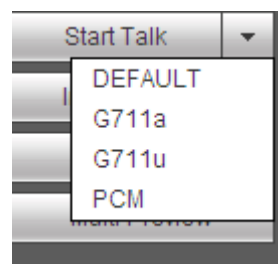

Figure 5-6

- Section 5: Instant record button. Click it, the button becomes yellow and system begins manual record. See Figure 5-7. Click it again, system restores previous record mode.

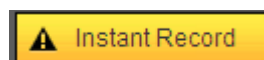

Figure 5-7

- Section 6: Local play button.

The Web can playback the saved (Extension name is dav) files in the PC-end.

Click local play button, system pops up the following interface for you to select local play file. See Figure 5-8.



Figure 5-8

- Section 7: Zero-channel encoding. Please refer to chapter 5.6 for detailed information.
- Section 8: PTZ operation panel. Please refer to chapter 5.4 for detailed information.
- Section 9: Image setup and alarm setup. Please refer to chapter 5.5 for detailed information.
- Section 10: From the left to the right ,you can see video quality/fluency/ full screen/1-window/4-window/6-window/8-window/9-window/13-window/16-window/20-window/25-window/36-window.. You can set video fluency and real-time feature priority.

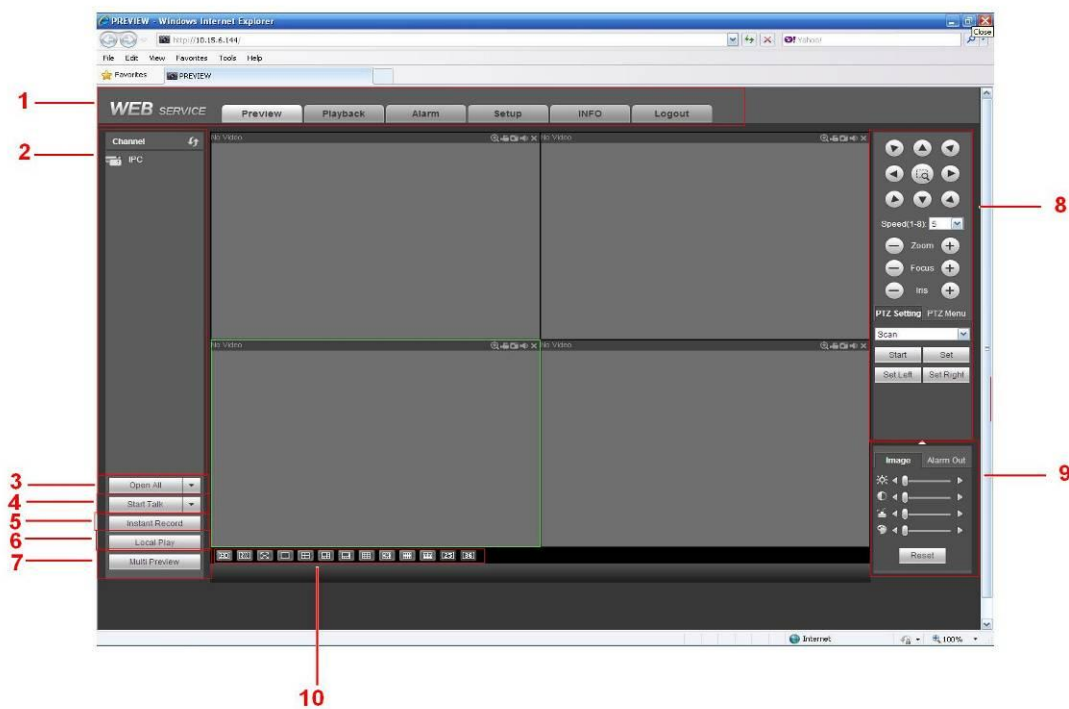

Figure 5-9

5.3 Real-time Monitor

In section 2, left click the channel name you want to view, you can see the corresponding video in current window.

On the top left corner, you can view device IP(172.11.10.111), channel number(1), network monitor bit stream(2202Kbps) and stream type(M=main stream, S=sub stream). See Figure 5-10.

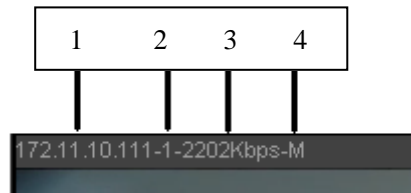

Figure 5-10

On the top right corner, there are six unction buttons. See Figure 5-11.

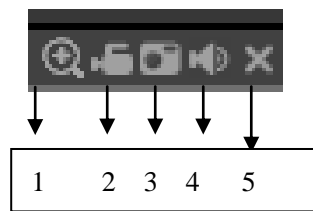

Figure 5-11

- 1: Digital zoom: Click this button and then left drag the mouse in the zone to zoom in. right click mouse system restores original status.
- 2: Local record. When you click local record button, the system begins recording and this button becomes highlighted. You can go to system folder RecordDownload to view the recorded file.
- 3: Snapshot picture. You can snapshot important video. All images are memorized in system client folder PictureDownload (default).
- 4: Audio :Turn on or off audio.(It has no relationship with system audio setup)
- 5: Close video.

5.4 PTZ

Before PTZ operation, please make sure you have properly set PTZ protocol. (Please refer to chapter 5.8.5.10).

There are eight direction keys. In the middle of the eight direction keys, there is a 3D intelligent positioning key.

Click 3D intelligent positioning key, system goes back to the single screen mode. Drag the mouse in the screen to adjust section size. It can realize PTZ automatically.

Please refer to the following sheet for PTZ setup information.

Parameter	Function
Scan	<ul style="list-style-type: none"> ● Select Scan from the dropdown list. ● Click Set button, you can set scan left and right limit. ● Use direction buttons to move the camera to you desired location and then click left limit button. Then move the camera again and then click right limit button to set a right limit.

Parameter	Function
Preset	<ul style="list-style-type: none"> Select Preset from the dropdown list. Turn the camera to the corresponding position and Input the preset value. Click Add button to add a preset.
Tour	<ul style="list-style-type: none"> Select Tour from the dropdown list. Input preset value in the column. Click Add preset button, you have added one preset in the tour. Repeat the above procedures you can add more presets in one tour. Or you can click delete preset button to remove one preset from the tour.
Pattern	<ul style="list-style-type: none"> Select Pattern from the dropdown list. You can input pattern value and then click Start button to begin PTZ movement such as zoom, focus, iris, direction and etc. Then you can click Add button to set one pattern.
Aux	<ul style="list-style-type: none"> Please input the corresponding aux value here. You can select one option and then click AUX on or AUX off button.
Light and wiper	You can turn on or turn off the light/wiper.



Figure 5-12

5.5 Image/Alarm-out

Select one monitor channel video and then click Image button in section 9, the interface is shown as Figure 5-13.

5.5.1 Image

Here you can adjust its brightness, contrast, hue and saturation. (Current channel border becomes green).

Or you can click Reset button to restore system default setup.

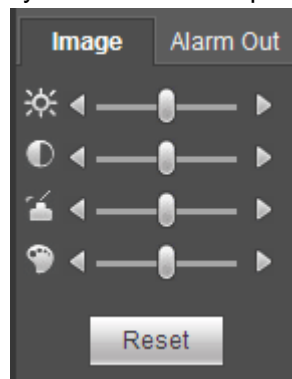

Figure 5-13

5.5.2 Alarm output

Here you can enable or disable the alarm signal of the corresponding port. See Figure 5-14.



Figure 5-14

5.6 Zero-channel Encode

Select a window and then click zero-channel encode button, the interface is shown as below. See Figure 5-15.

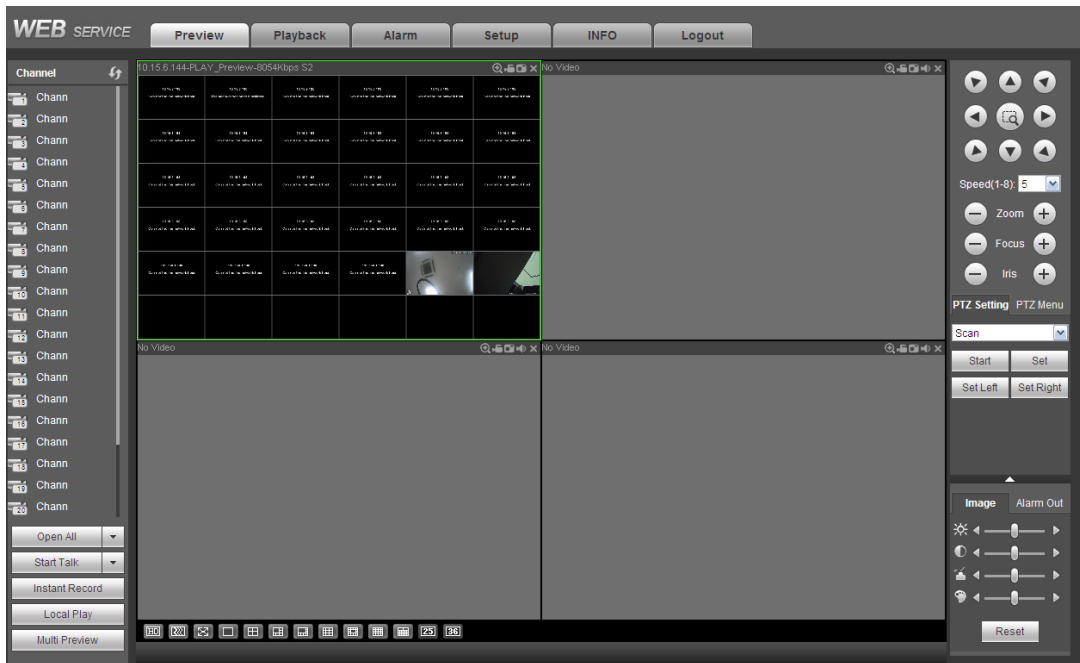

Figure 5-15

5.7 WAN Login

In WAN mode, after you logged in, the interface is shown as below. See Figure 5-16.



Figure 5-16

Please refer to the following contents for LAN and WAN login difference.

- 1) In the WAN mode, system opens the main stream of the first channel to monitor by default. The open/close button on the left pane is null.
- 2) You can select different channels and different monitor modes at the bottom of the interface. See

Figure 5-17.



Figure 5-17

Important

The window display mode and the channel number are by default. For example, for the 16-channel, the max window split mode is 16.

3) Multiple-channel monitor, system adopts extra stream to monitor by default. Double click one channel, system switches to single channel and system uses main stream to monitor. You can view there are two icons at the left top corner of the channel number for you reference. M stands for main stream. S stands for sub stream (extra stream).

4) If you login via the WAN mode, system does not support alarm activation to open the video function in the Alarm setup interface.

Important

- For multiple-channel monitor mode, system adopts extra stream to monitor by default. You can not modify manually. All channels are trying to synchronize. Please note the synchronization effect still depends on your network environments.
- For bandwidth consideration, system can not support monitor and playback at the same time. System auto closes monitor or playback interface when you are searching setup in the configuration interface. It is to enhance search speed.

5.8 Setup

5.8.1 Camera

5.8.1.1 Registration

From Main menu->Setting->Camera->Registration, you can see the following interface. See Figure 5-18.

MANAGE

Device Search

CH	Status	Name	IP Address	Add/Del	Type	Modify
1	--	--	172.32.5.198	+		
2	--	--	10.15.18.81	+		
3	--	--	10.15.6.82	+		
4	--	--	10.15.6.244	+		
5	--	--	10.15.1.0	+		
6	--	--	10.15.5.82	+		
7	--	--	10.1.1.65	+		
8	--	--	10.15.1.65	+		
9	--	--	10.15.6.87	+		
10	--	--	10.15.6.86	+		
11	--	--	10.15.5.88	+		
12	--	--	10.15.70.25	+		
13	--	--	10.1.1.70	+		
14	--	--	10.1.1.67	+		
15	--	--	10.1.1.71	+		
16	--	--	10.1.1.69	+		
17	--	--	10.15.8.52	+		
18	--	--	10.15.5.123	+		
19	--	--	10.1.1.70	+		
20	--	--	10.15.6.77	+		

Manual Add Refresh

Figure 5-18

Manual Add

Channel:

Manufacturer:

IP Address:

TCP Port: (1~65535)

User Name:

Password:

Remote Channel No.:



Decode Buffer: ms(80~480)

Save Cancel

Figure 5-19

Please refer to the following sheet for parameter information.

Parameter	Function
Device search	Click Device search button, you can view the searched device information on the list. It includes device IP address, port, device name, manufacturer and type.
Add	Select a device in the list and then click Add button, system can connect the device automatically and add it to the Added device list. Or you can double click one item in the list to add a device.
Modify	Click or any device in the Added device list, you can change the corresponding channel setup.

Parameter	Function
Delete	Click  , you can delete the remote connection of the corresponding channel.
Type	There are two connection types. You can use the network to connect to the camera or use the WIFI. The  means current network camera connection mode is general; the  means current network camera mode is hotspot.
Delete	Select a device in the Added device list and then click Delete button, system can disconnect the device and remove it from the Added device list.
Manual Add	<p>Click it, the interface is shown as in Figure 5-19. Here you can add network camera manually.</p> <p>You can select a channel from the dropdown list (Here only shows disconnection channel.)</p> <p>Note:</p> <ul style="list-style-type: none"> ● System supports manufactures such as Panasonic, Sony, Dynacolor, Samsung, AXIS, Arecont, Dahua and Onvif standard protocol. ● If you do not input IP address here. System uses default IP 192.168.0.0 and system does not connect to this IP. ● Can not add two devices at the same time. Click OK button here, system only connect to the corresponding device of current channel.

5.8.1.2 Image

Note

Slight difference may be found since the connected network camera may not be same model.

Here you can view device property information. The setups become valid immediately after you set. See Figure 5-20.

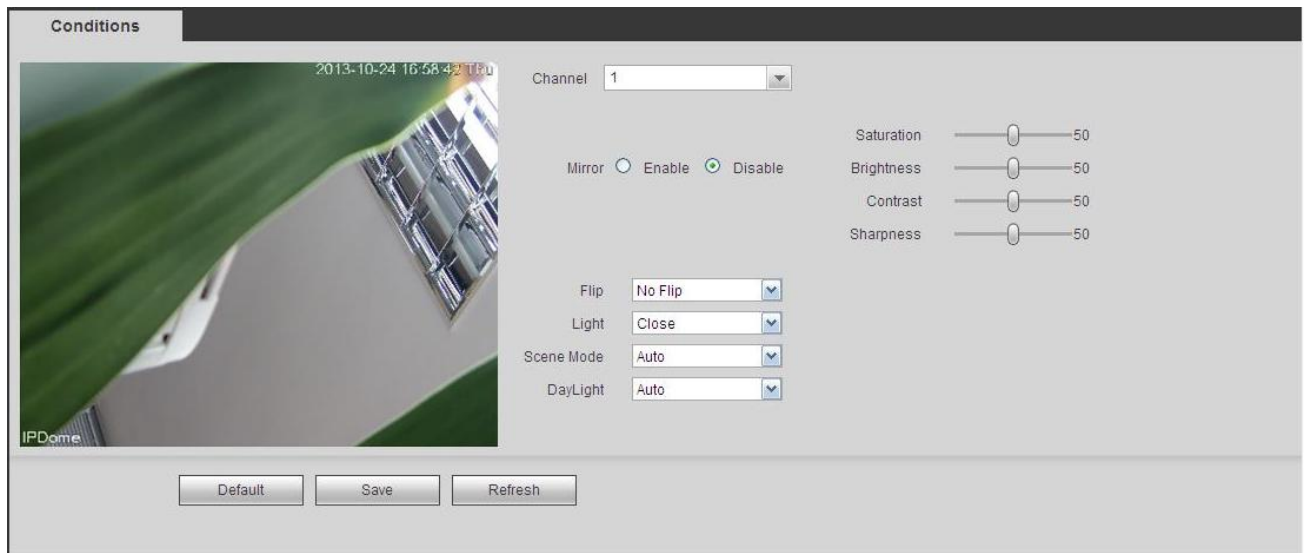

Figure 5-20

Please refer to the following sheet for detailed information.

Parameter	Function
Channel	Please select a channel from the dropdown list.
Period	It divides one day (24 hours) to two periods. You can set different hue, brightness, and contrast for different periods.
Hue	It is to adjust monitor video brightness and darkness level. The default value is 50. The bigger the value is, the large the contrast between the bright and dark section is and vice versa.
Brightness	It is to adjust monitor window brightness. The default value is 50. The larger the number is, the bright the video is. When you input the value here, the bright section and the dark section of the video will be adjusted accordingly. You can use this function when the whole video is too dark or too bright. Please note the video may become hazy if the value is too high. The value ranges from 0 to 100. The recommended value ranges from 40 to 60.
Contrast	It is to adjust monitor window contrast. The value ranges from 0 to 100. The default value is 50. The larger the number is, the higher the contrast is. You can use this function when the whole video bright is OK but the contrast is not proper. Please note the video may become hazy if the value is too low. If this value is too high, the dark section may lack brightness while the bright section may over exposure. The recommended value ranges from 40 to 60.
Saturation	It is to adjust monitor window saturation. The value ranges from 0 to 100. The default value is 50. The larger the number is, the strong the color is. This value has no effect on the general brightness of the whole video. The video color may become too strong if the value is too high. For the grey part of the video, the distortion may occur if the white balance is not accurate. Please note the video may not be

		attractive if the value is too low. The recommended value ranges from 40 to 60.
Gain		The gain adjust is to set the gain value. The smaller the value is, the low the noise is. But the brightness is also too low in the dark environments. It can enhance the video brightness if the value is high. But the video noise may become too clear.
White level		It is to enhance video effect.
Color mode		It includes several modes such as standard, color. You can select corresponding color mode here, you can see hue, brightness, and contrast and etc will adjust accordingly.
Auto Iris		It is to enable/disable auto iris function.
Flip		It is to switch video up and bottom limit. This function is disabled by default.
Mirror		It is to switch video left and right limit. This function is disabled by default.
BLC Mode	BLC	The device auto exposures according to the environments situation so that the darkest area of the video is cleared
	WDR	For the WDR scene, this function can lower the high bright section and enhance the brightness of the low bright section. So that you can view these two sections clearly at the same time. The value ranges from 1 to 100. When you switch the camera from no-WDR mode to the WDR mode, system may lose several seconds record video.
	HLC	After you enabled HLC function, the device can lower the brightness of the brightest section according to the HLC control level. It can reduce the area of the halo and lower the brightness of the whole video.
	Off	It is to disable the BLC function. Please note this function is disabled by default.
Profile		It is to set the white balance mode. It has effect on the general hue of the video. This function is on by default. You can select the different scene mode such as auto, sunny, cloudy, home, office, night, disable and etc to adjust the video to the best quality. <ul style="list-style-type: none"> ● Auto: The auto white balance is on. System can auto compensate the color temperature to make sure the vide color is proper. ● Sunny: The threshold of the white balance is in the sunny mode. ● Night: The threshold of the white balance is in the night mode. ● Customized: You can set the gain of the red/blue channel. The value renegees from 0 to 100.
Day/Night		It is to set device color and the B/W mode switch. The default setup is auto. <ul style="list-style-type: none"> ● Color: Device outputs the color video. ● Auto: Device auto select to output the color or the B/W

	<p>video according to the device feature (The general bright of the video or there is IR light or not.)</p> <ul style="list-style-type: none"> ● B/W: The device outputs the black and white video. ● Sensor: It is to set when there is peripheral connected IR light.
--	---

5.8.1.3 Encode

5.8.1.3.1 Encode

The encode interface is shown as below. See Figure 5-21.

Figure 5-21

Please refer to the following sheet for detailed information.

Parameter	Function
Channel	Please select a channel from the dropdown list.
Video enable	Check the box here to enable extra stream video. This item is enabled by default.
Code stream type	<p>It includes main stream, motion stream and alarm stream. You can select different encode frame rates form different recorded events.</p> <p>System supports active control frame function (ACF). It allows you to record in different frame rates.</p> <p>For example, you can use high frame rate to record important events, record scheduled event in lower frame rate and it allows you to set different frame rates for motion detection record and alarm record.</p>
Compression	The main bit stream supports H.264. The extra stream supports H.264, MJPG.
Resolution	The resolution here refers to the capability of the network camera.

Frame Rate	PAL: 1~25f/s; NTSC: 1~30f/s.
Bit Rate	<ul style="list-style-type: none"> ● Main stream: You can set bit rate here to change video quality. The large the bit rate is, the better the quality is. Please refer to recommend bit rate for the detailed information. ● Extra stream: In CBR, the bit rate here is the max value. In dynamic video, system needs to low frame rate or video quality to guarantee the value. The value is null in VBR mode.
Reference bit rate	Recommended bit rate value according to the resolution and frame rate you have set.
I Frame	Here you can set the P frame amount between two I frames. The value ranges from 1 to 150. Default value is 50. Recommended value is frame rate *2.
Enable audio	Check the box to enable audio function. The audio of the main stream is enabled by default. When this function is enabled, the record file has audio/video composite stream. For the sub stream, please check the video first and then enable audio.
Watermark enable	This function allows you to verify the video is tampered or not. Here you can select watermark bit stream, watermark mode and watermark character. Default character is DigitalCCTV. The max length is 85-digit. The character can only include number, character and underline.

5.8.1.3.2 Snapshot

The snapshot interface is shown as in Figure 5-22.

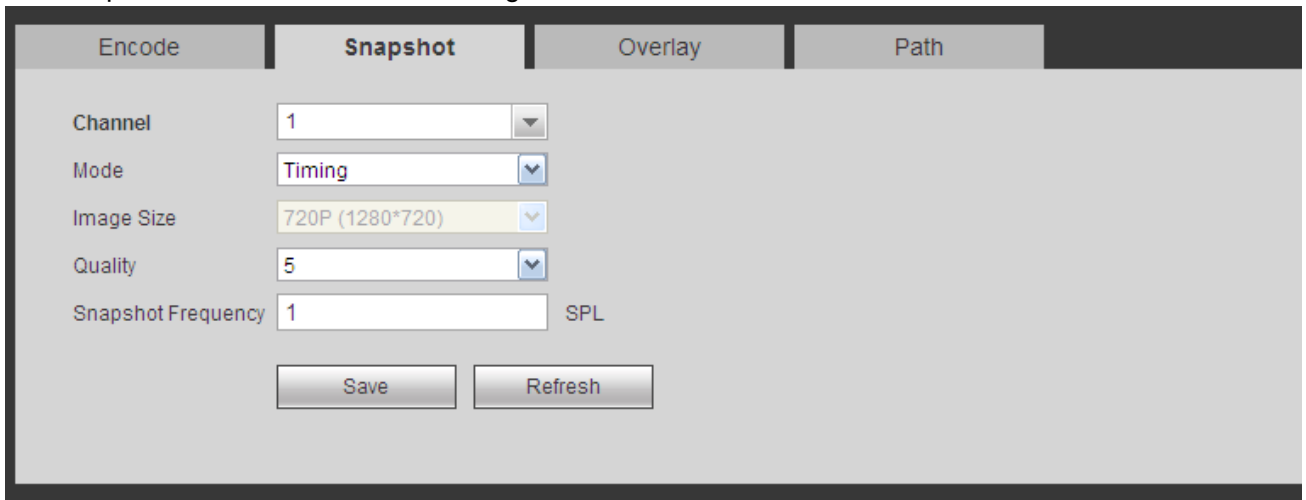

Figure 5-22

Please refer to the following sheet for detailed information.

Parameter	Function
Snapshot type	<p>There are two modes: Regular (schedule) and Trigger.</p> <ul style="list-style-type: none"> ● Regular snapshot is valid during the specified period you set. ● Trigger snapshot only is valid when motion detect alarm, tampering alarm or local activation alarm occurs.

Image size	It is the same with the resolution of the main stream.
Quality	It is to set the image quality. There are six levels.
Interval	It is to set snapshot frequency. The value ranges from 1s to 7s. Or you can set customized value. The max setup is 3600s/picture.
Copy	Click it; you can copy current channel setup to other channel(s).

5.8.1.3.3 Video Overlay

The video overlay interface is shown as in Figure 5-23.

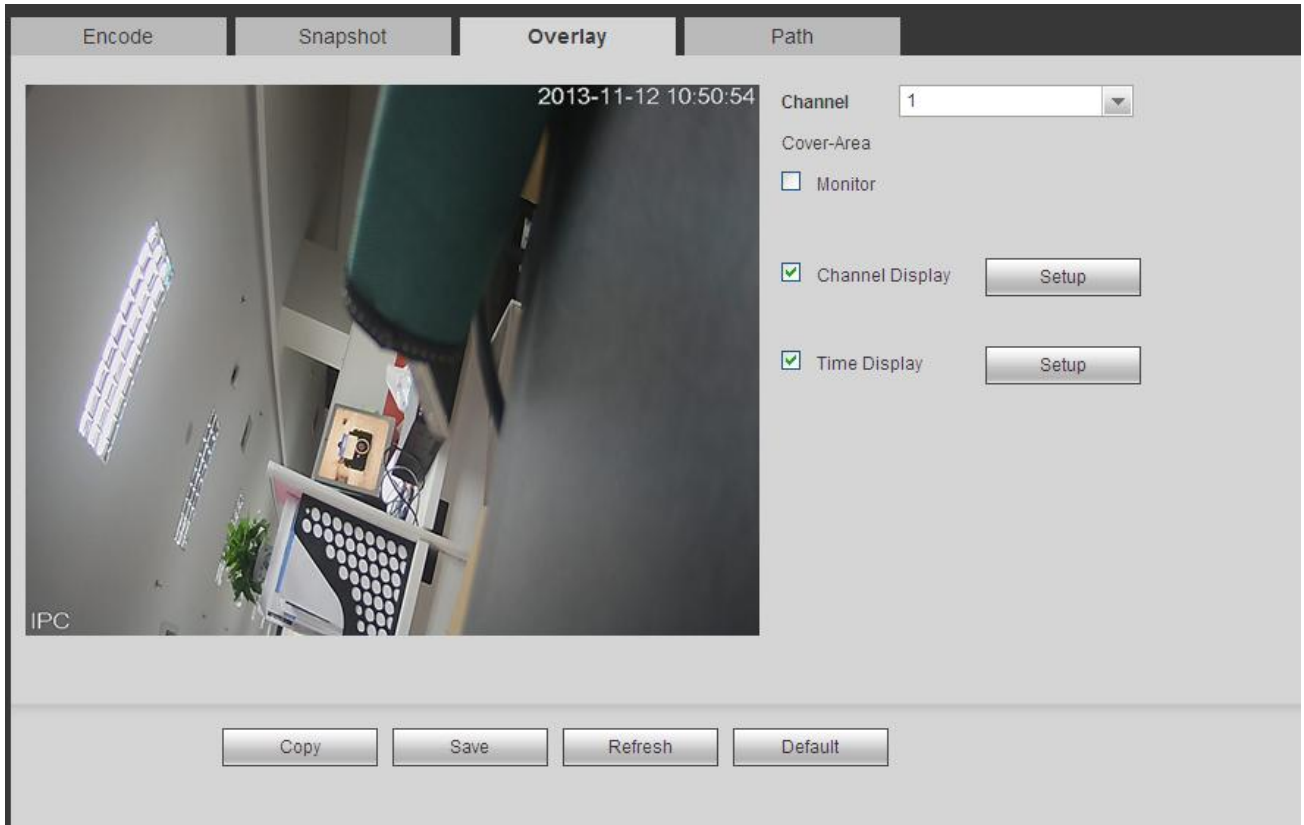

Figure 5-23

Please refer to the following sheet for detailed information.

Parameter	Function
Cover-area	Check Preview or Monitor first. Click Set button, you can privacy mask the specified video in the preview or monitor video. System max supports 4 privacy mask zones.
Time Title	You can enable this function so that system overlays time information in video window. You can use the mouse to drag the time title position. You can view time title on the live video of the WEB or the playback video.
Channel Title	You can enable this function so that system overlays channel information in video window. You can use the mouse to drag the channel title position. You can view channel title on the live video of the WEB or the playback video.

5.8.1.3.4 Path

The storage path interface is shown as in Figure 5-24.

Here you can set snap image saved path ( in the preview interface) and the record storage path ( in the preview interface). The default setup is C:\PictureDownload and C:\RecordDownload. Please click the Save button to save current setup.

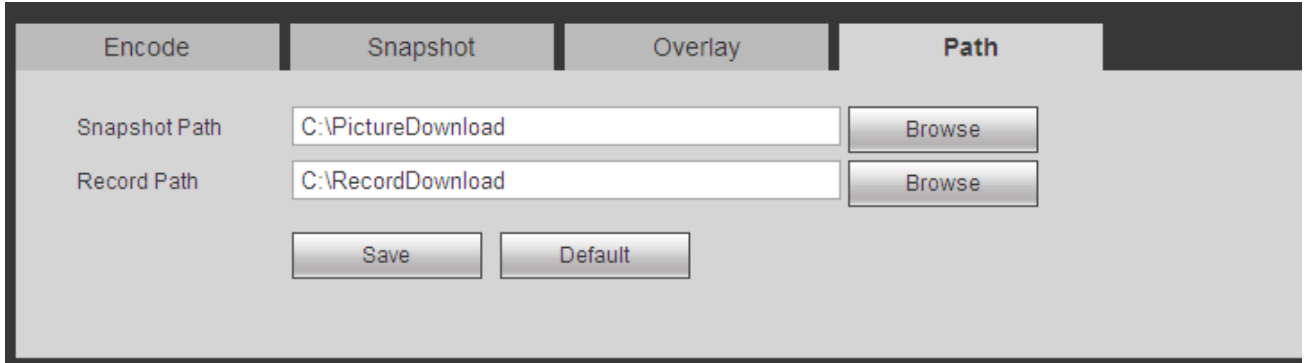

Figure 5-24

5.8.1.4 Channel Name

Here you can set channel name. See Figure 5-25.

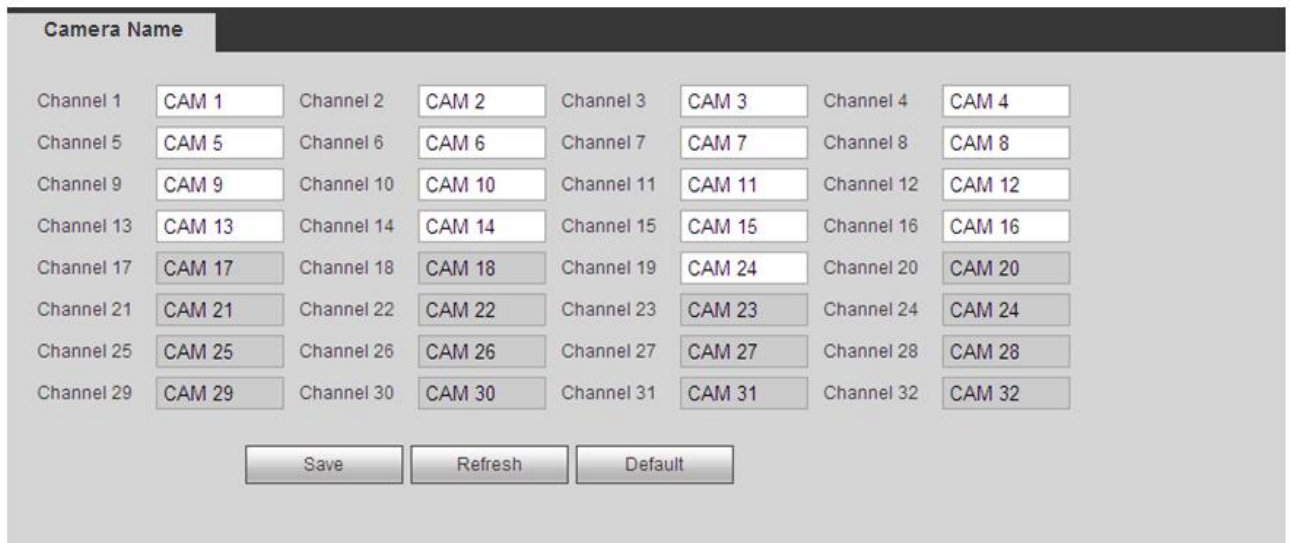

Figure 5-25

5.8.1.5 IPC Upgrade

This interface is to upgrade network camera. See Figure 5-26.

Click Browse button to select upgrade file. Or you can use filter to select several network cameras at the same time.

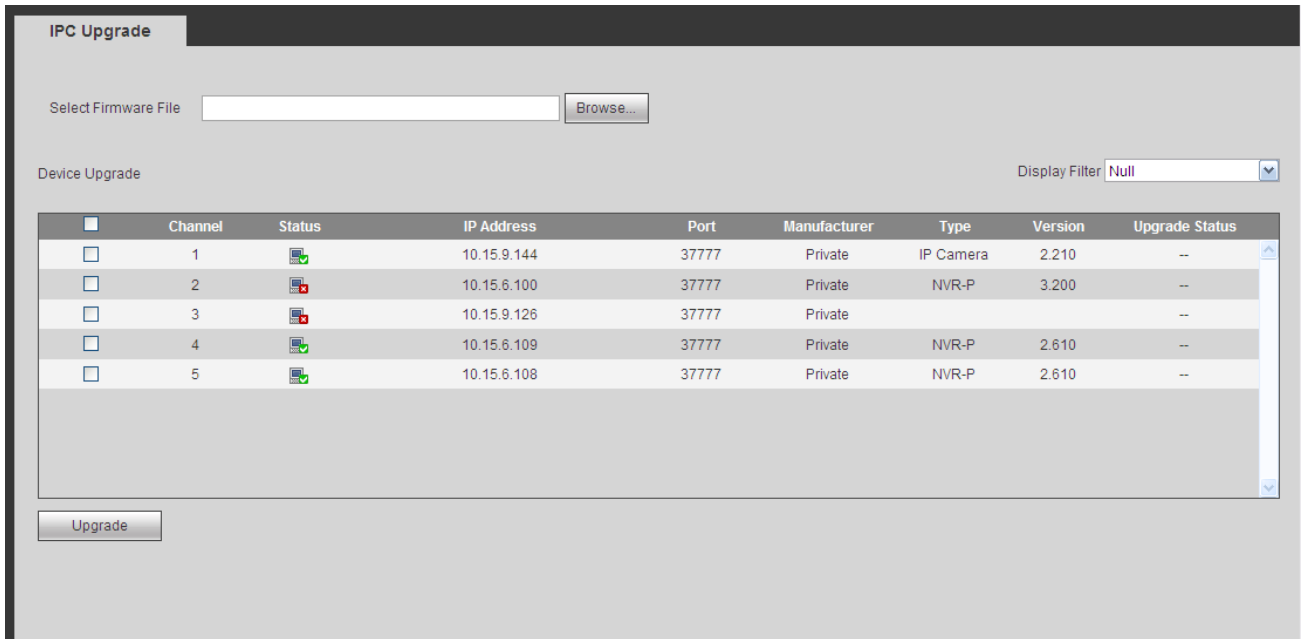

Figure 5-26

5.8.2 Network

5.8.2.1 TCP/IP

The TCP/IP interface is shown as in Figure 5-27.

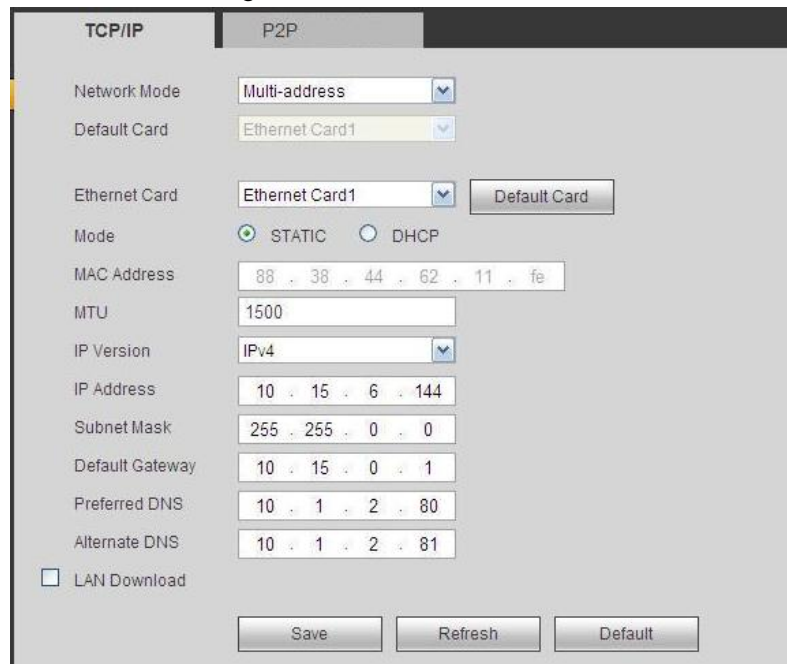

Figure 5-27

Please refer to the following sheet for detailed information.

Parameter	Function
Mode	<p>There are two modes: static mode and the DHCP mode.</p> <ul style="list-style-type: none"> The IP/submask/gateway are null when you select the DHCP mode to auto search the IP. If you select the static mode, you need to set the

	<p>IP/submask/gateway manually.</p> <ul style="list-style-type: none"> ● If you select the DHCP mode, you can view the IP/submask/gateway from the DHCP. ● If you switch from the DHCP mode to the static mode, you need to reset the IP parameters. ● Besides, IP/submask/gateway and DHCP are read-only when the PPPoE dial is OK.
Mac Address	It is to display host Mac address.
IP Version	It is to select IP version. IPV4 or IPV6. You can access the IP address of these two versions.
IP Address	Please use the keyboard to input the corresponding number to modify the IP address and then set the corresponding subnet mask and the default gateway.
Preferred DNS	DNS IP address.
Alternate DNS	Alternate DNS IP address.
For the IP address of IPv6 version, default gateway, preferred DNS and alternate DNS, the input value shall be 128-digit. It shall not be left in blank.	
LAN load	System can process the downloaded data first if you enable this function. The download speed is 1.5X or 2.0X of the normal speed.

5.8.2.2 Connection

The connection interface is shown as in Figure 5-28.

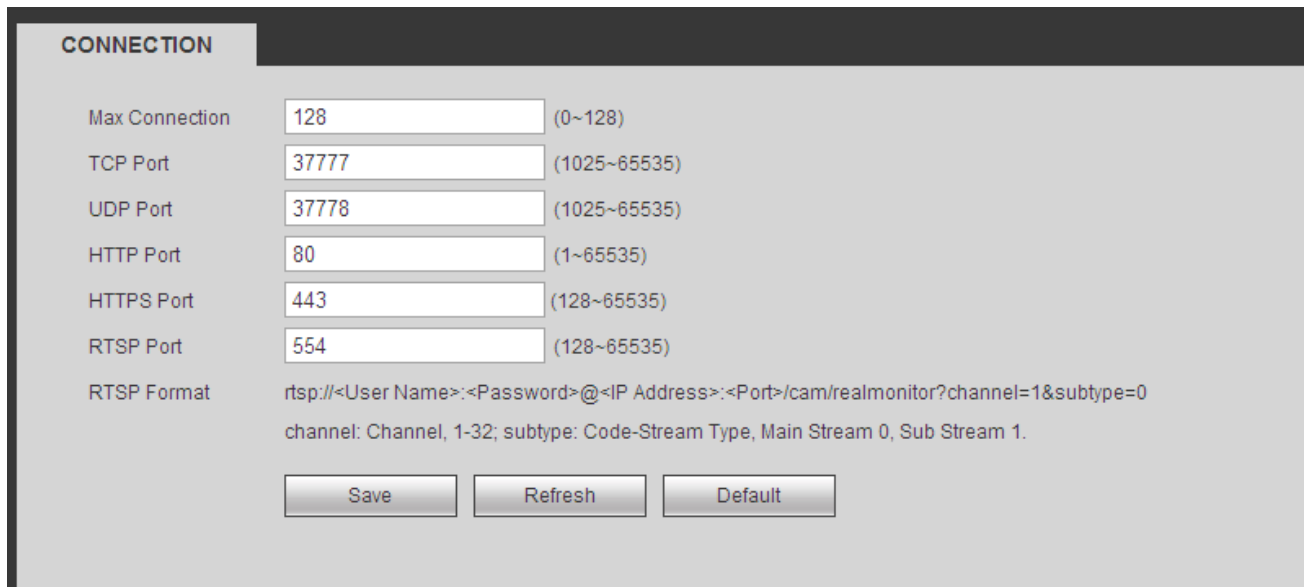

CONNECTION

Max Connection: (0~128)

TCP Port: (1025~65535)

UDP Port: (1025~65535)

HTTP Port: (1~65535)

HTTPS Port: (128~65535)

RTSP Port: (128~65535)

RTSP Format: rtsp://<User Name>:<Password>@<IP Address>:<Port>/cam/realmonitor?channel=1&subtype=0
channel: Channel, 1-32; subtype: Code-Stream Type, Main Stream 0, Sub Stream 1.

Figure 5-28

Please refer to the following sheet for detailed information.

Parameter	Function
Max connection	It is the max Web connection for the same device. The value ranges from 1 to 120. The default setup is 120.
TCP port	The default value is 37777. You can input the actual port

	number if necessary.
UDP port	The default value is 37778. You can input the actual port number if necessary.
HTTP port	The default value is 80. You can input the actual port number if necessary.
HTTPS	The default value is 443. You can input the actual port number if necessary.
RTSP port	The default value is 554.

5.8.2.3 WIFI AP

Please note this function is for some series only.

5.8.2.3.1 General Setup

The WIFI AP interface is shown as in Figure 5-29. Here you can set WIFI hotspot, so that the network camera can use the hotspot to connect to the network.

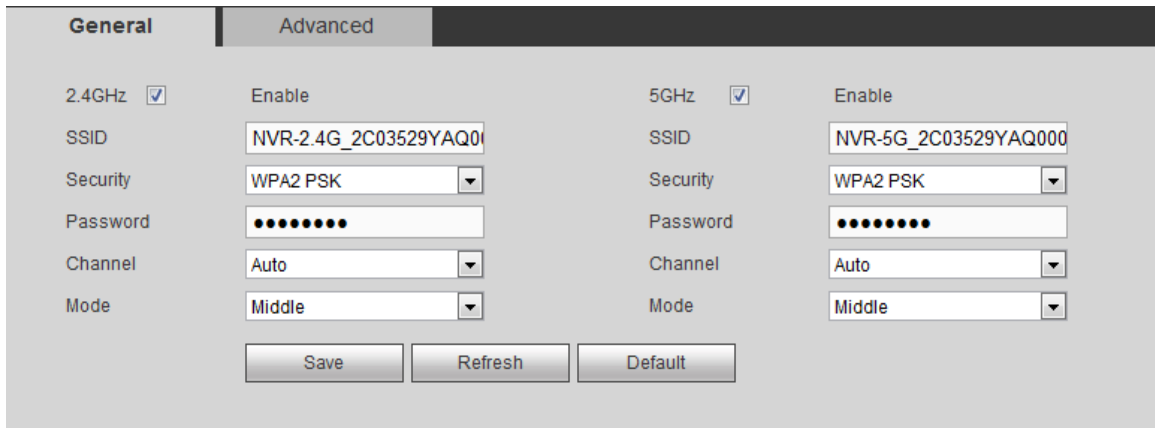

Figure 5-29

Please refer to the following sheet for detailed information.

Parameter	Function
SSID	It is to set SSID name. You can use this name to search the device.
Password	It is to set SSID password. You can use this password to connect to the network.
Security	Select authentication from the dropdown list.
Start IP/End IP	Input start IP and end IP. The NVR can allocate the IP address in the range you specified here.
WPS	Click WPS button to enable WPS function. After the network camera enabled this function, it can automatically connect to the network.
Remote device	In the list, you can view the network camera(s) that connected to the NVR. It includes signal intensity, IP, MAC address, bit rate, channel number, type, status and etc.

5.8.2.3.2 Advanced

Click Advanced button, the interface is shown as below. See Figure 5-30.

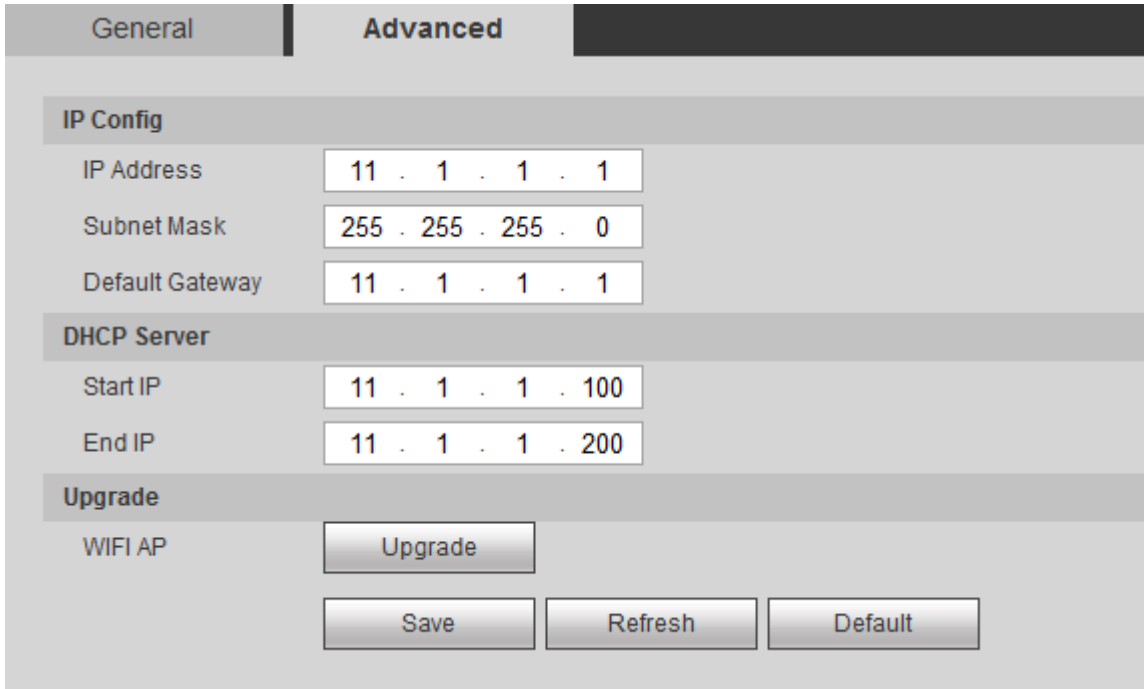

Figure 5-30

Please refer to the following sheet for detailed information.

Parameter	Function
IPv4 address	Input WIFI AP IP address.
IPv4 netmask	Input WIFI AP network mask.
IPv4 gateway	Input WIFI AP gateway.
Start IP/End IP	Input start IP and end IP. The NVR can allocate the IP address in the range you specified here.
Upgrade	Click it to upgrade WIFI AP module.

5.8.2.4 WIFI

Please note this function is for the device of WIFI module.

The WIFI interface is shown as in Figure 5-31.

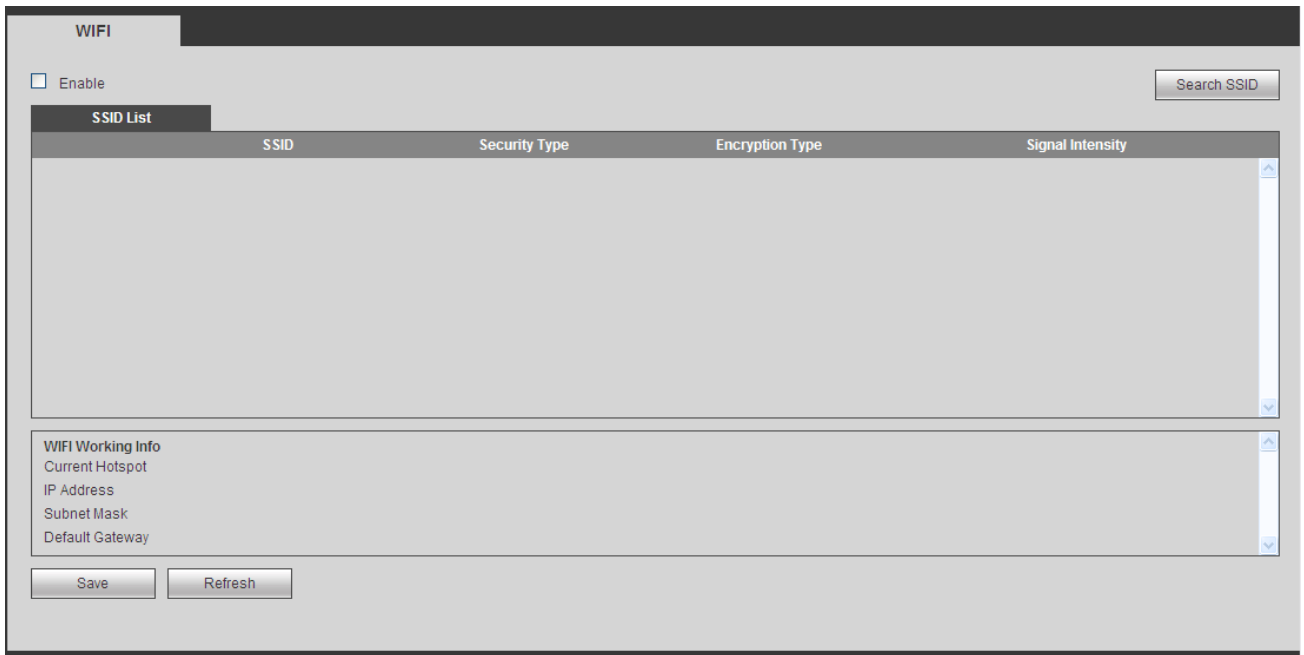

Figure 5-31

Please check the box to enable WIFI function and then click the Search SSID button. Now you can view all the wireless network information in the following list. Double click a name to connect to it. Click Refresh button, you can view latest connection status.

5.8.2.5 3G

5.8.2.5.1 CDMA/GPRS

The CDMA/GPRS interface is shown as in Figure 5-32.

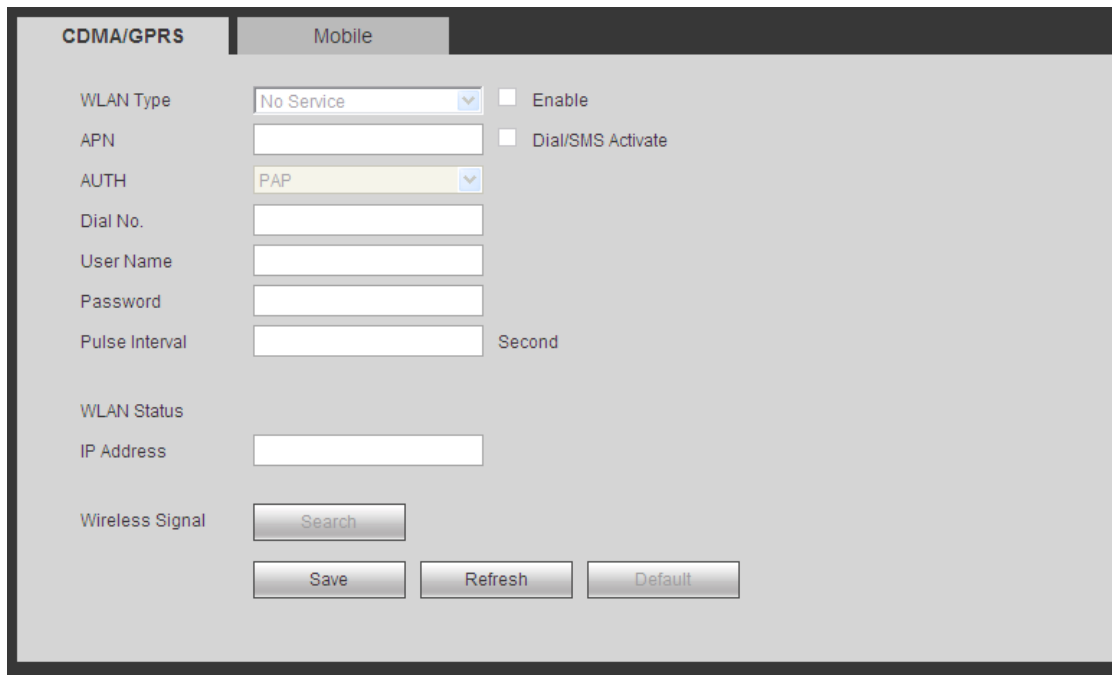

Figure 5-32



Please refer to the following sheet for detailed information.

Parameter	Function
WLAN type	Here you can select 3G network type to distinguish the 3G module from different ISP. The types include WCDMA, CDMA1x and etc.
APN/Dial No.	Here is the important parameter of PPP.
Authorization	It includes PAP,CHAP,NO_AUTH.
Pulse interval	It is to set time to end 3G connection after you close extra stream monitor. For example, if you input 60 here, system ends 3G connection after you close extra stream monitor 60 seconds.
Important <ul style="list-style-type: none"> ✦ If the pulse interval is 0, then system does not end 3G connection after you close the extra stream monitor. ✦ Pulse interval here is for extra stream only. This item is null if you are using main stream to monitor. 	

5.8.2.5.2 Mobile

The mobile setup interface is shown as in Figure 5-33.

Here you can activate (send out “on”) or turn off (Send out “off”) the 3G connected phone or mobile phone, or the phone you set to get alarm message.

Check send SMS box and then input the phone number in the receiver column. Click  to add one receiver. Repeat the above steps you can add more phones. Select a phone number and then click , you can delete it. Click OK button to complete the setup.

The screenshot shows the 'Mobile' configuration page under the 'CDMA/GPRS' tab. It features three main sections: 'Send SMS', 'SMS Activate', and 'Tel Activate'. Each section has a checkbox and a corresponding input field with '+' and '-' buttons. The 'Receiver' field under 'Send SMS' contains the number '18969021865'. The 'Sender' field under 'SMS Activate' also contains '18969021865'. Below these fields is a 'Title' field with the text 'NVR Message'. At the bottom of the page are three buttons: 'Save', 'Refresh', and 'Default'.

Figure 5-33

5.8.2.6 PPPoE

The PPPoE interface is shown as in Figure 5-34.

Input the PPPoE user name and password you get from the IPS (internet service provider) and enable PPPoE function. Please save current setup and then reboot the device to get the setup activated.

Device connects to the internet via PPPoE after reboot. You can get the IP address in the WAN from the IP address column.

Please note, you need to use previous IP address in the LAN to login the device. Please go to the IP address item to via the device current device information. You can access the client-end via this new address.

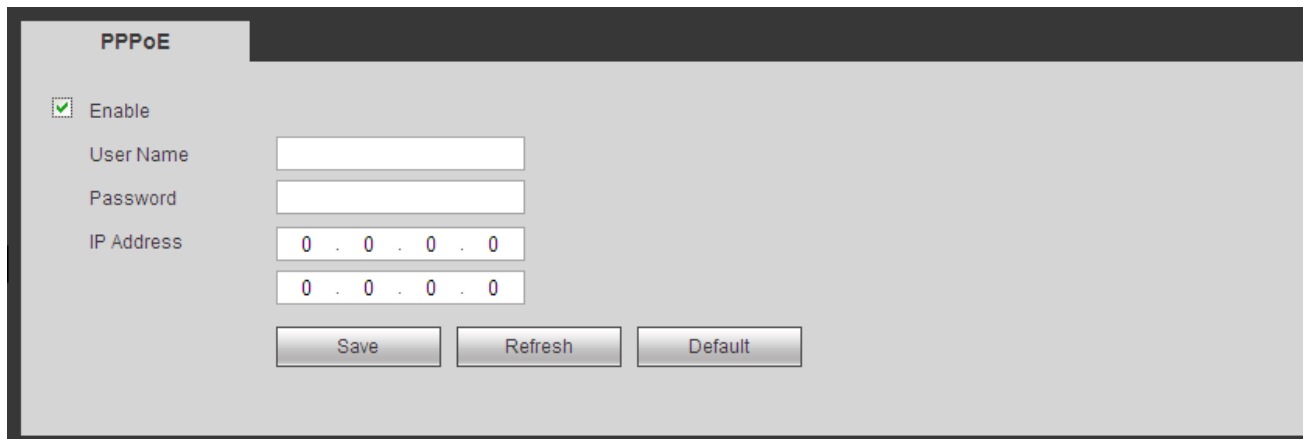

Figure 5-34

5.8.2.7 DDNS

The DDNS interface is shown as in Figure 5-35.

The DDNS is to set to connect the various servers so that you can access the system via the server. Please go to the corresponding service website to apply a domain name and then access the system via the domain. It works even your IP address has changed.

Please select DDNS from the dropdown list (Multiple choices). Before you use this function, please make sure your purchased device support current function.

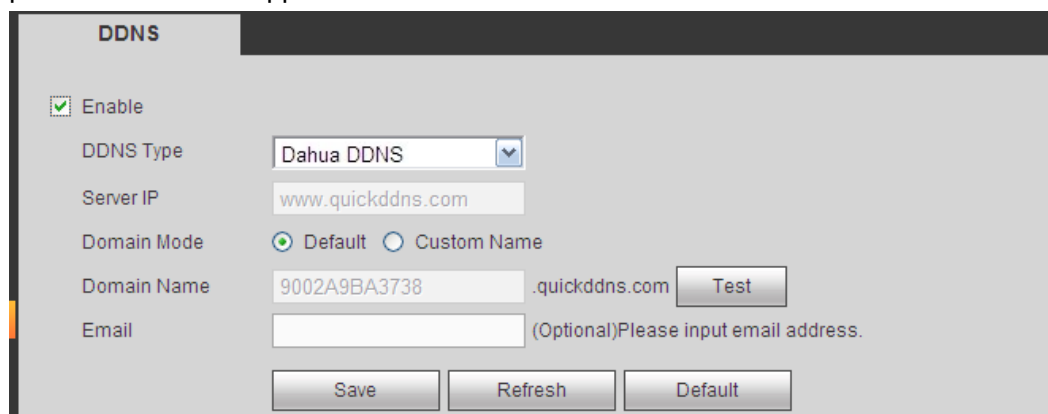

Figure 5-35

Please refer to the following sheet for detailed information.

Parameter	Function
Server Type	You can select DDNS protocol from the dropdown list and then enable DDNS function.

Parameter	Function
Server IP	DDNS server IP address
Server Port	DDNS server port.
Domain Name	Your self-defined domain name.
User	The user name you input to log in the server.
Password	The password you input to log in the server.
Update period	Device sends out alive signal to the server regularly. You can set interval value between the device and DDNS server here.

Dahua DDNS and Client-end Introduction

1) Background Introduction

Device IP is not fixed if you use ADSL to login the network. The DDNS function allows you to access the NVR via the registered domain name. Besides the general DDNS, the Dahua DDNS works with the device from the manufacturer so that it can add the extension function.

2) Function Introduction

The Dahua DDNS client has the same function as other DDNS client end. It realizes the bonding of the domain name and the IP address. Right now, current DDNS server is for our own devices only. You need to refresh the bonding relationship of the domain and the IP regularly. There is no user name, password or the ID registration on the server. At the same time, each device has a default domain name (Generated by MAC address) for your option. You can also use customized valid domain name (has not registered.).

3) Operation

Before you use Dahua DDNS, you need to enable this service and set proper server address, port value and domain name.

- Server address: www.dahuaddns.com
- Port number: 80
- Domain name: There are two modes: Default domain name and customized domain name.

Except default domain name registration, you can also use customized domain name (You can input your self-defined domain name.) After successful registration, you can use domain name to login installed of the device IP.

- User name: It is optional. You can input your commonly used email address.

Important

- Do not register frequently. The interval between two registrations shall be more than 60 seconds. Too many registration requests may result in server attack.
- System may take back the domain name that is idle for one year. You can get a notification email before the cancel operation if your email address setup is OK.

5.8.2.8 IP filter

The IP filter interface is shown as in Figure 5-36.

After you enabled trusted sites function, only the IP listed below can access current NVR.

If you enable blocked sites function, the following listed IP addresses can not access current NVR.

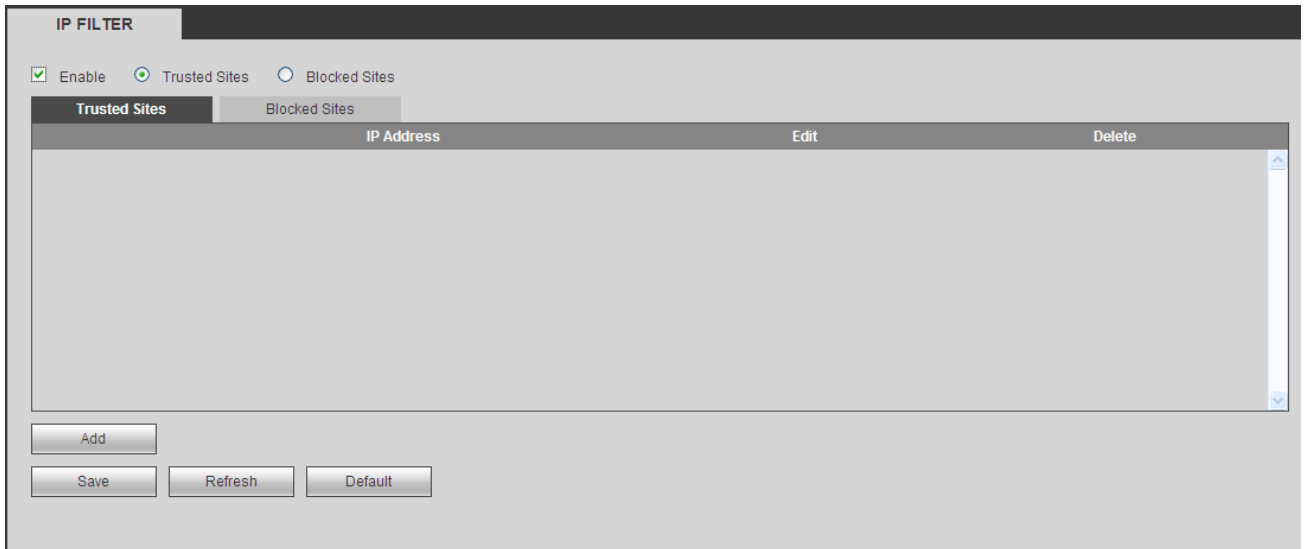

Figure 5-36

5.8.2.9 Email

The email interface is shown as in Figure 5-37.

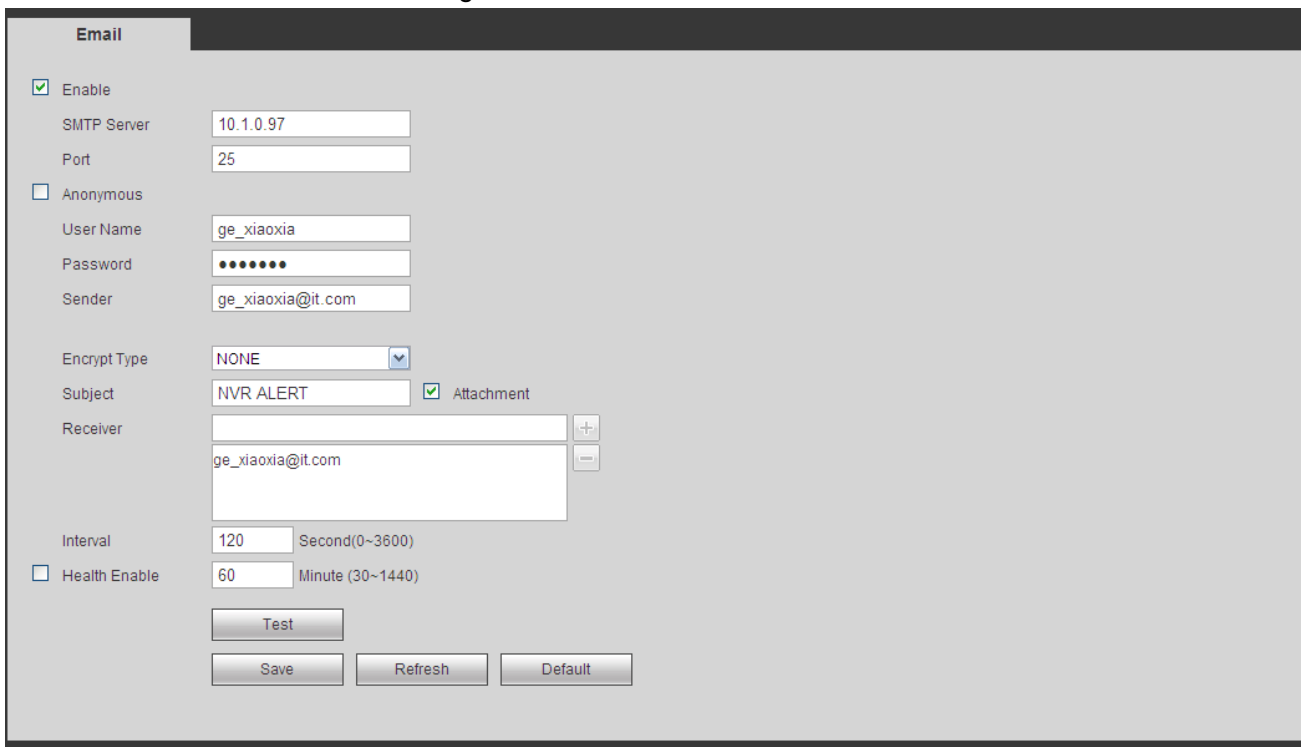

Figure 5-37

Please refer to the following sheet for detailed information.

Parameter	Function
Enable	Please check the box here to enable email function.
SMTP Server	Input server address and then enable this function.
Port	Default value is 25. You can modify it if necessary.

Parameter	Function
Anonymity	For the server supports the anonymity function. You can auto login anonymously. You do not need to input the user name, password and the sender information.
User Name	The user name of the sender email account.
Password	The password of sender email account.
Sender	Sender email address.
Authentication (Encryption mode)	You can select SSL or none.
Subject	Input email subject here.
Attachment	System can send out the email of the snapshot picture once you check the box here.
Receiver	Input receiver email address here. Max three addresses. It supports SSL, TLS email box.
Interval	The send interval ranges from 0 to 3600 seconds. 0 means there is no interval. Please note system will not send out the email immediately when the alarm occurs. When the alarm, motion detection or the abnormality event activates the email, system sends out the email according to the interval you specified here. This function is very useful when there are too many emails activated by the abnormality events, which may result in heavy load for the email server.
Health mail enable	Please check the box here to enable this function.
Update period (interval)	This function allows the system to send out the test email to check the connection is OK or not. Please check the box to enable this function and then set the corresponding interval. The value ranges from 30 minutes to 1440 minutes. System can send out the email regularly as you set here.
Email test	The system will automatically sent out a email once to test the connection is OK or not .Before the email test, please save the email setup information.

5.8.2.10 UPnP

It allows you to establish the mapping relationship between the LAN and the public network.

Here you can also add, modify or remove UPnP item. See Figure 5-38.

- In the Windows OS, From Start->Control Panel->Add or remove programs. Click the “Add/Remove Windows Components” and then select the “Network Services” from the Windows Components Wizard.
- Click the Details button and then check the “Internet Gateway Device Discovery and Control client” and “UPnP User Interface”. Please click OK to begin installation.
- Enable UPnP from the Web. If your UPnP is enabled in the Windows OS, the NVR can auto detect it via the “My Network Places”

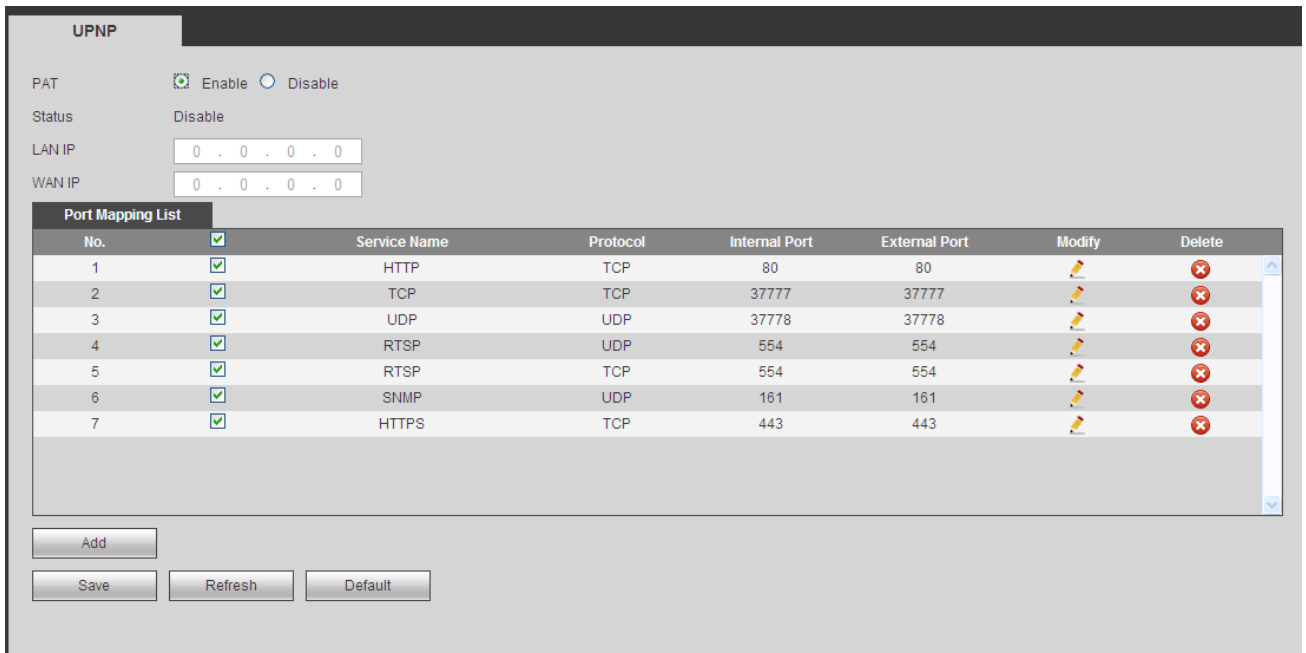



Figure 5-38

Please refer to the following sheet for detailed information.

Parameter	Function
PAT	Check the corresponding box to enable PAT function.
Status	Display UPnP function status.
Port mapping list	<p>It is corresponding to the UPnP mapping information on the router. Check the box before the service name to enable current PAT service. Otherwise, the service is null.</p> <ul style="list-style-type: none"> • Service name: Customized name. • Protocol: Protocol type. • Internal port: The port mapped to the port. • External port: The port current device needs to map. • Device has three mapping items: HTTP/TCP/UDP. <p>Note When you set the external port (output) of the router, the value ranges from 1024 to 5000. Do not use port 1~255 or system port 256~1023, in case there is conflict.</p>
Add	<p>Click Add button to add map relationship.</p> <p>Note For the data transmission protocol TCP/UDP, the external port and the internal port shall be the same to guarantee proper data transmission.</p>
Delete	Select one service and then click  to delete map relationship.

5.8.2.11 SNMP

The SNMP interface is shown as in Figure 5-39.

The SNMP allows the communication between the network management work station software and the proxy of the managed device. It is reserved for the 3rd party to develop.

SNMP V1/V2

Enable

SNMP Port (0~65535)

Read Community

Write Community

Trap Address

Trap Port (0~65535)

Version V1 V2

Figure 5-39

Please refer to the following sheet for detailed information.

Parameter	Function
SNMP Port	The listening port of the proxy program of the device. It is a UDP port not a TCP port. The value ranges from 1 to 65535. The default value is 161
Read Community	It is a string. It is a command between the manage process and the proxy process. It defined the authentication, access control and the management relationship between one proxy and one group of the managers. Please make sure the device and the proxy are the same. The read community will read all the objects the SNMP supported in the specified name. The default setup is public.
Write Community	It is a string. It is a command between the manage process and the proxy process. It defined the authentication, access control and the management relationship between one proxy and one group of the managers. Please make sure the device and the proxy are the same. The read community will read/write/access all the objects the SNMP supported in the specified name. The default setup is write.
Trap address	The destination address of the Trap information from the proxy program of the device.
Trap port	The destination port of the Trap information from the proxy program of the device. It is for the gateway device and the client-end PC in the LAN to exchange the information. It is a non-protocol connection port. It has no effect on the network applications. It is a UDP port not TCP port. The value ranges from 1 to 165535. The default value is 162.
SNMP version	<ul style="list-style-type: none"> ● Check V1, system only processes the information of V1. ● Check V2, system only processes the information of V2.

5.8.2.12 Multicast

The multicast interface is shown as in Figure 5-40.

Multicast is a transmission mode of data packet. When there is multiple-host to receive the same data

packet, multiple-cast is the best option to reduce the broad width and the CPU load. The source host can just send out one data to transit. This function also depends on the relationship of the group member and group of the outer.

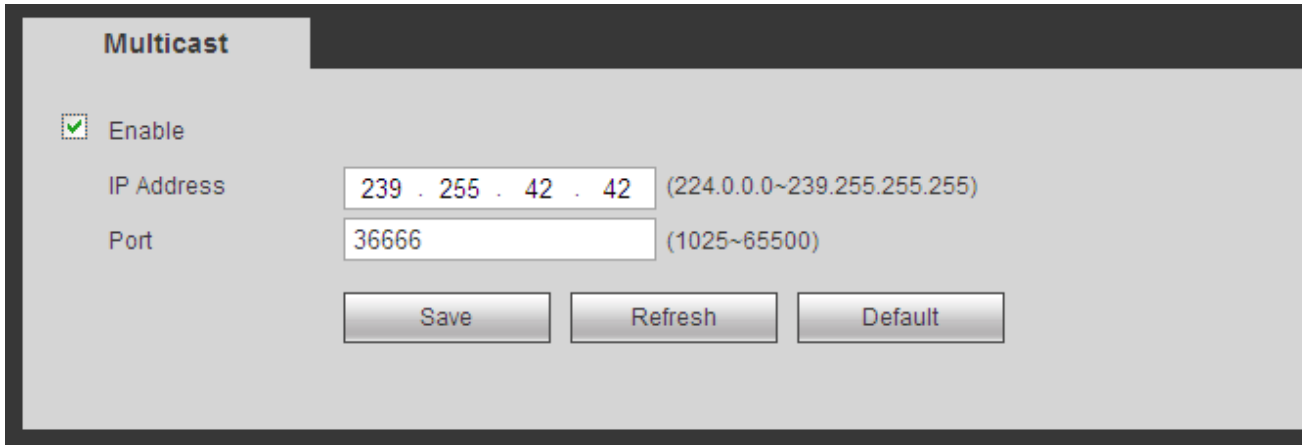

Figure 5-40

5.8.2.13 Auto Register

The auto register interface is shown as below. See Figure 5-41.

This function allows the device to auto register to the proxy you specified. In this way, you can use the client-end to access the NVR and etc via the proxy. Here the proxy has a switch function. In the network service, device supports the server address of IPv4 or domain.

Please follow the steps listed below to use this function.

Please set proxy server address, port, and sub-device name at the device-end. Please enable the auto register function, the device can auto register to the proxy server.



Figure 5-41

5.8.2.14 Alarm Centre

The alarm center interface is shown as below. See Figure 5-42.

This interface is reserved for you to develop. System can upload alarm signal to the alarm center when local alarm occurs.

Before you use alarm center, please set server IP, port and etc. When an alarm occurs, system can send out data as the protocol defined, so the client-end can get the data.

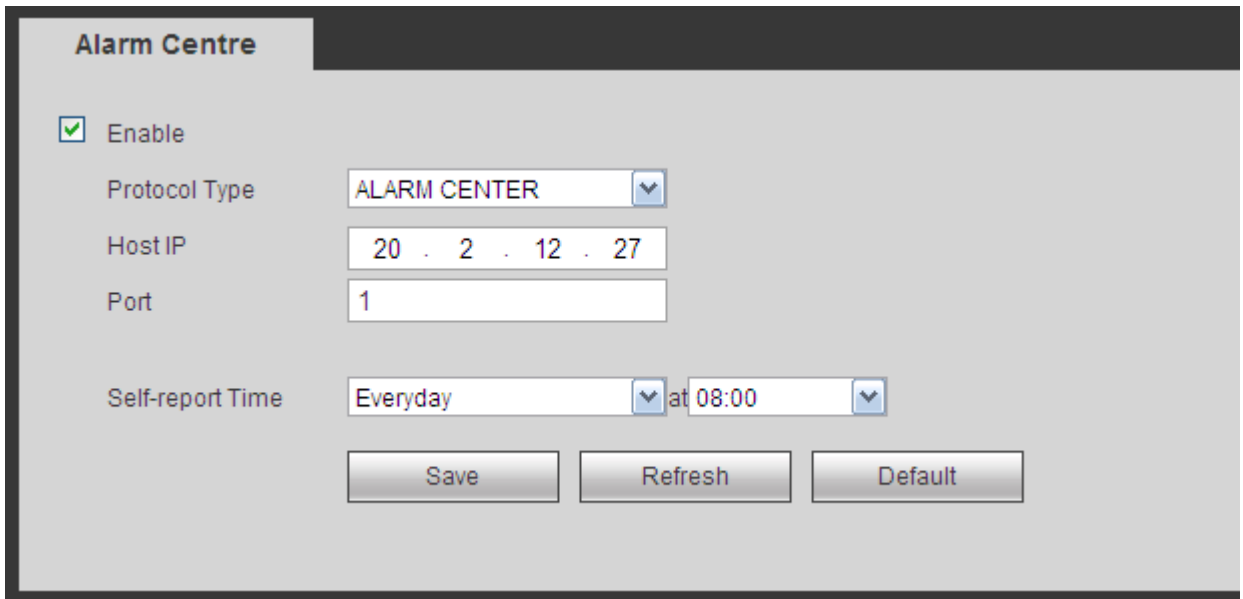

Figure 5-42

5.8.2.15 HTTPS

In this interface, you can set to make sure the PC can successfully login via the HTTPS. It is to guarantee communication data security. The reliable and stable technology can secure the user information security and device safety. See Figure 5-43.

Note

- You need to implement server certificate again if you have changed device IP.
- You need to download root certificate if it is your first time to use HTTPS on current PC.

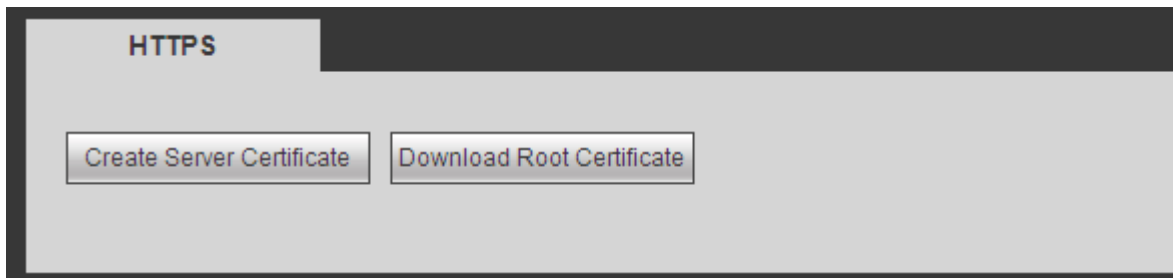
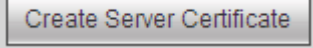

Figure 5-43

5.8.2.15.1 Create Server Certificate

If it is your first time to use this function, please follow the steps listed below.

In Figure 5-43, click  button, input country name, state name and etc. Click Create button. See Figure 5-44.

Note

Please make sure the IP or domain information is the same as your device IP or domain name.

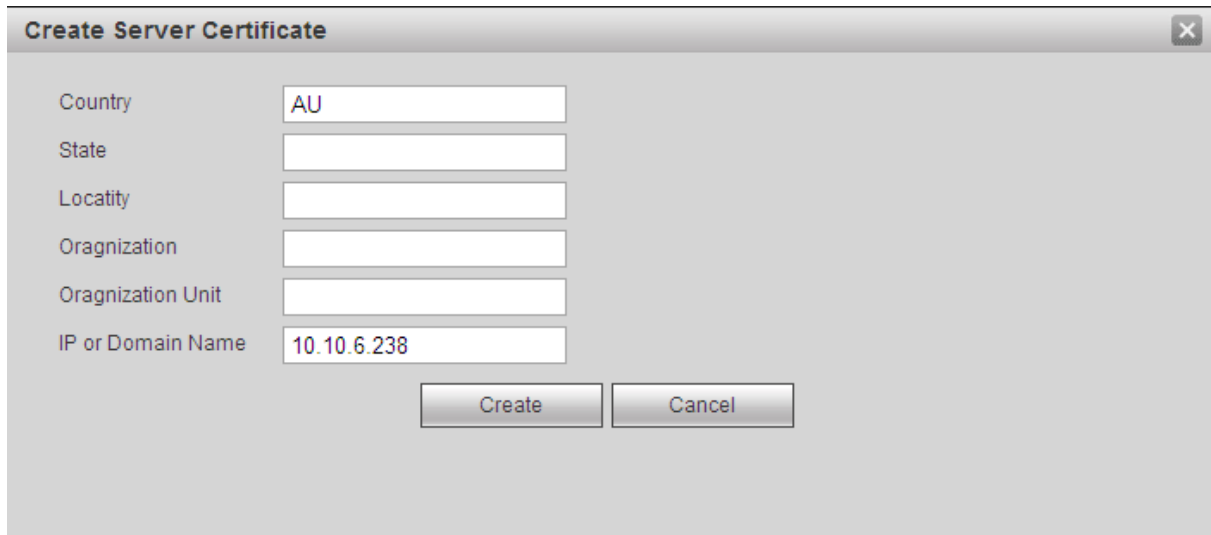

Figure 5-44

You can see the corresponding prompt. See Figure 5-45. Now the server certificate is successfully created.



Figure 5-45

5.8.2.15.2 Download root certificate

In Figure 5-43, click **Download Root Certificate** button, system pops up a dialogue box. See Figure 5-46.



Figure 5-46

Click Open button, you can go to the following interface. See Figure 5-47.

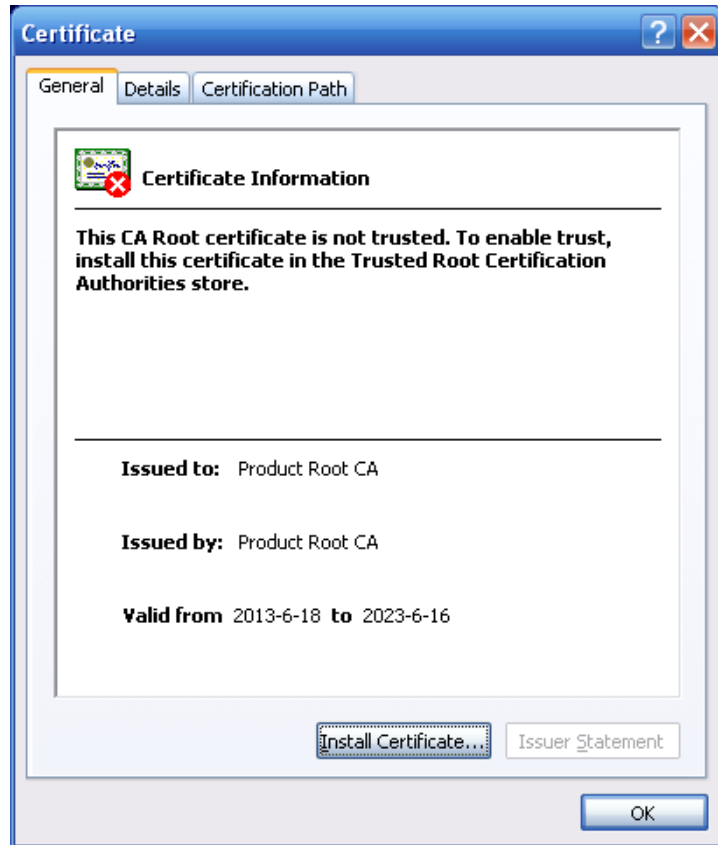

Figure 5-47

Click Install certificate button, you can go to certificate wizard. See Figure 5-48.



Figure 5-48

Click Next button to continue. Now you can select a location for the certificate. See Figure 5-49.



Figure 5-49

Click Next button, you can see the certificate import process is complete. See Figure 5-50.



Figure 5-50

Click Finish button, you can see system pops up a security warning dialogue box. See Figure 5-51.

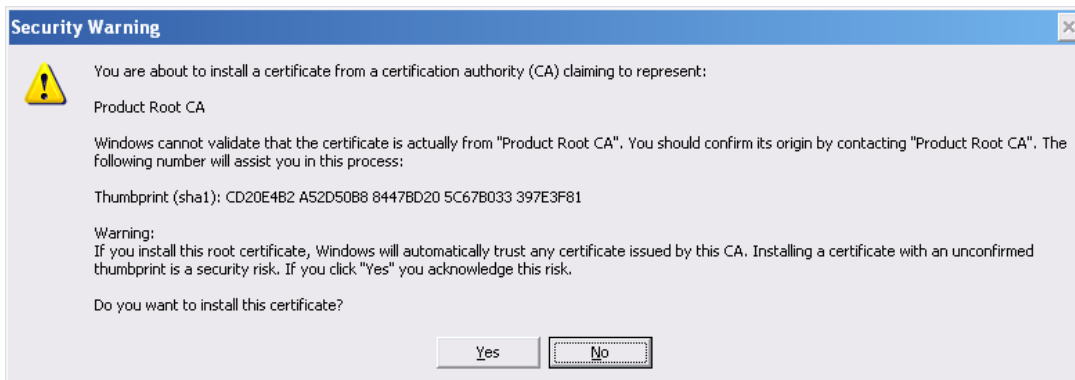

Figure 5-51

Click Yes button, system pops up the following dialogue box, you can see the certificate download is complete. See Figure 5-52.



Figure 5-52

5.8.2.15.3 View and set HTTPS port

From Setup->Network->Connection, you can see the following interface. See Figure 5-53. You can see HTTPS default value is 443.

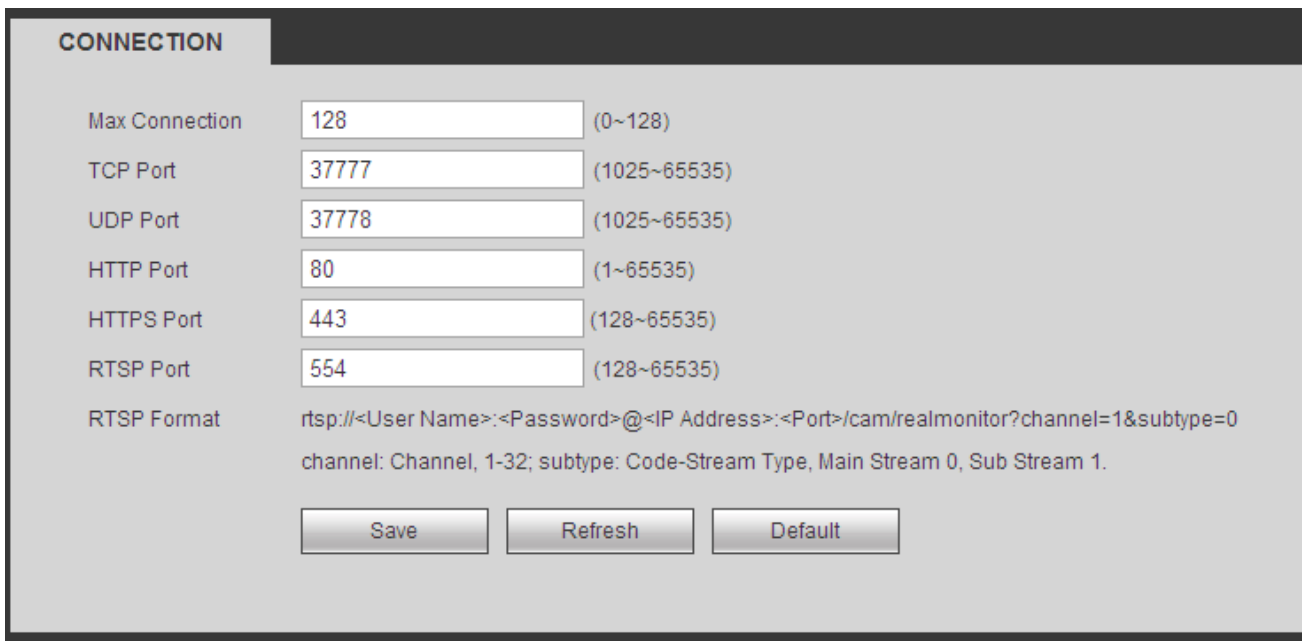

Figure 5-53

5.8.2.15.4 Login

Open the browser and then input <https://xx.xx.xx.xx:port>.

xx.xx.xx.xx: is your device IP or domain name.

Port is your HTTPS port. If you are using default HTTPS value 443, you do not need to add port information here. You can input <https://xx.xx.xx.xx> to access.

Now you can see the login interface if your setup is right.

5.8.2.16 P2P

You can use your cell phone to scan the QR code and add it to the cell phone client.

Via the SN from scanning the QR code, you can access the device in the WAN. Please refer to the P2P operation manual included in the resources CD.

The P2P interface is shown as in Figure 5-54.

Check the Enable box to enable P2P function and then click the Save button. Now you can view the device status and SN.

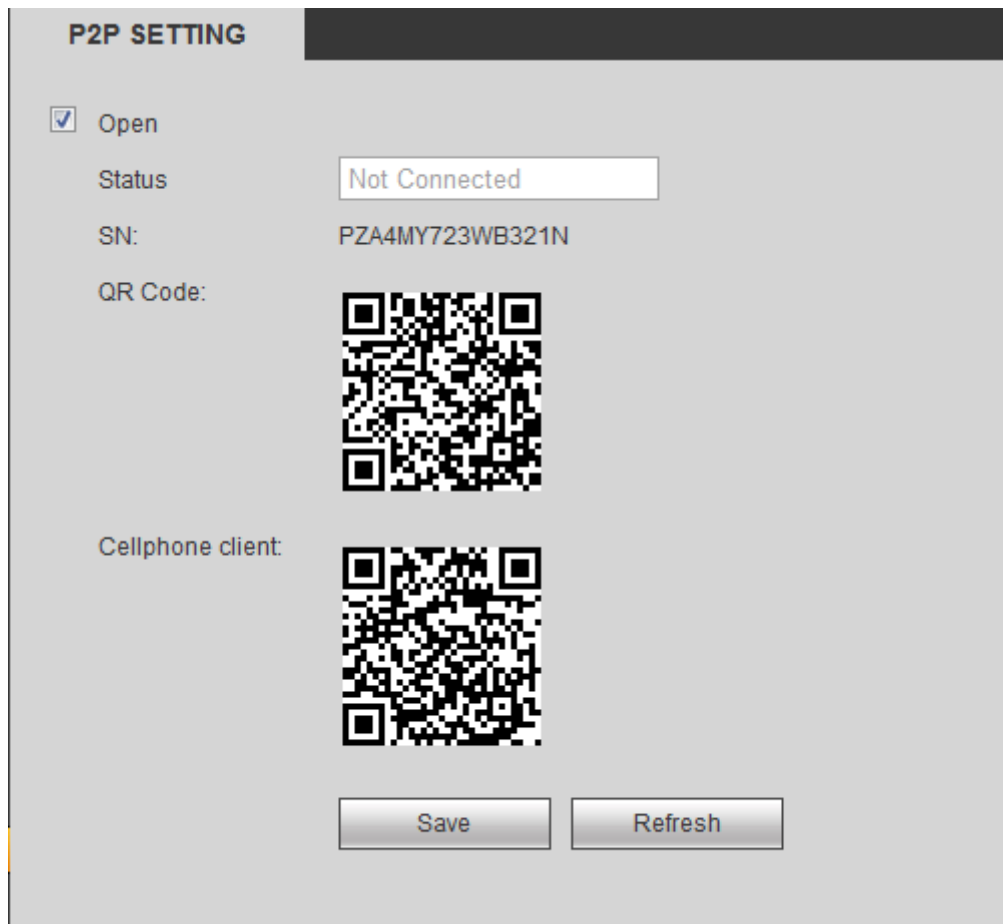

Figure 5-54

5.8.3 Event

5.8.3.1 Video detect

5.8.3.1.1 Motion Detect

After analysis video, system can generate a video loss alarm when the detected moving signal reached the sensitivity you set here.

The motion detect interface is shown as in Figure 5-55.

Motion Detect | Video Loss | Tampering

Enable 1

Period

Anti-dither 5 Second (5-600) Sensitivity 3

Region

Record Channel

Delay 10 Second (10-300)

Alarm Out 1 2 3

Latch 10 Second(1-300)

PTZ Activation

Tour

Snapshot

Show Message Send Email Alarm Upload Buzzer Message

Figure 5-55

Setup [X]

Thursday [v]

<input checked="" type="checkbox"/>	00 : 00	-	24 : 00
<input type="checkbox"/>	00 : 00	-	24 : 00
<input type="checkbox"/>	00 : 00	-	24 : 00
<input type="checkbox"/>	00 : 00	-	24 : 00
<input type="checkbox"/>	00 : 00	-	24 : 00
<input type="checkbox"/>	00 : 00	-	24 : 00

Figure 5-56

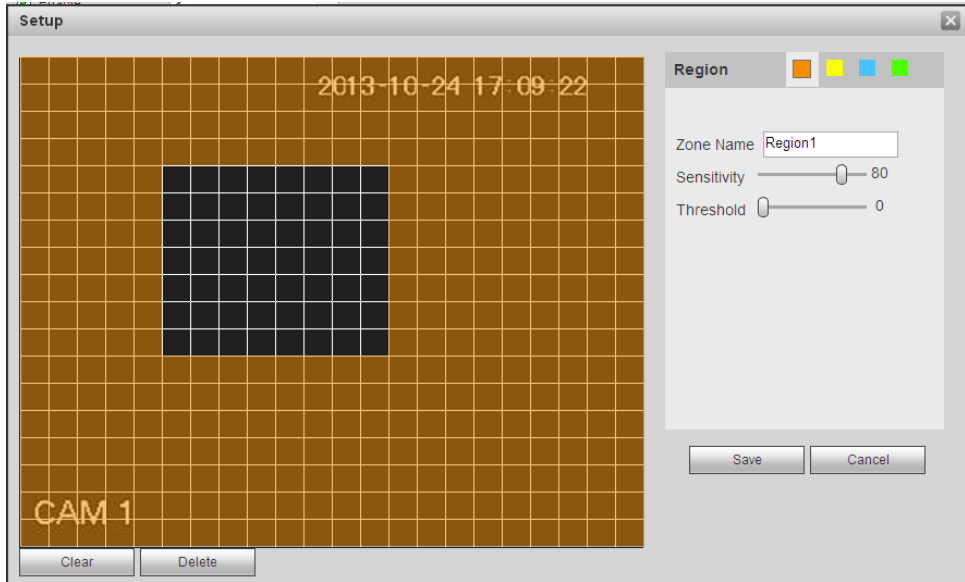

Figure 5-57

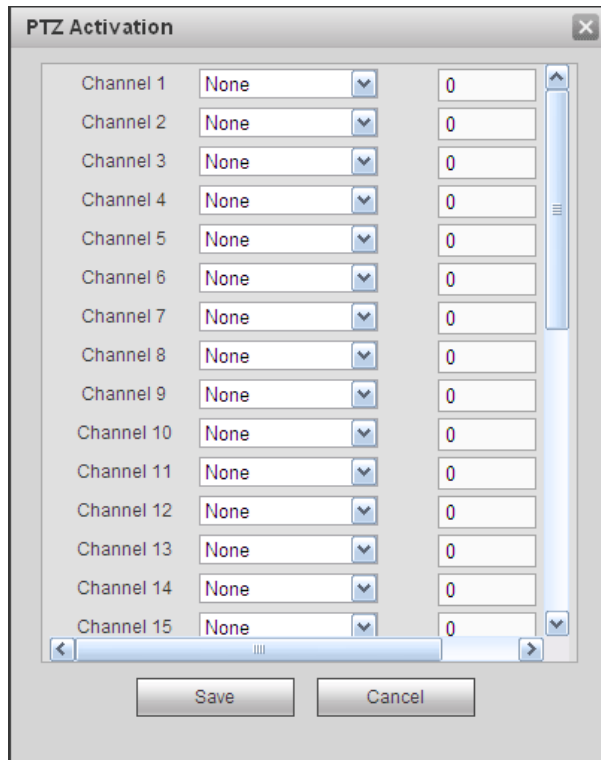

Figure 5-58

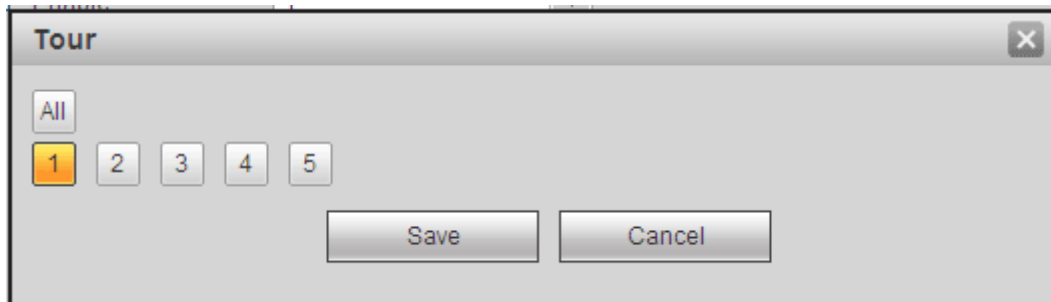

Figure 5-59

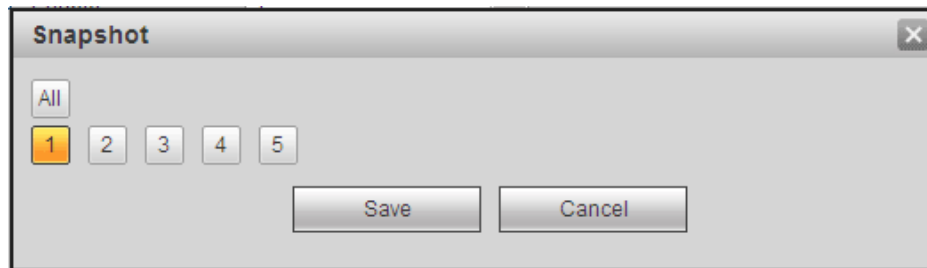

Figure 5-60

Please refer to the following sheet for detailed information.

Parameter	Function
Enable	You need to check the box to enable motion detection function. Please select a channel from the dropdown list.
Period	Motion detection function becomes activated in the specified periods. See Figure 5-56. There are six periods in one day. Please draw a circle to enable corresponding period. Click OK button, system goes back to motion detection interface, please click save button to exit.
Anti-dither	System only memorizes one event during the anti-dither period. The value ranges from 5s to 600s.
Sensitivity	There are six levels. The sixth level has the highest sensitivity.
Region	If you select motion detection type, you can click this button to set motion detection zone. The interface is shown as in Figure 5-57. Here you can set motion detection zone. There are four zones for you to set. Please select a zone first and then left drag the mouse to select a zone. The corresponding color zone displays different detection zone. You can click Fn button to switch between the arm mode and disarm mode. In arm mode, you can click the direction buttons to move the green rectangle to set the motion detection zone. After you completed the setup, please click ENTER button to exit current setup. Do remember click save button to save current setup. If you click ESC button to exit the region setup interface system will not save your zone setup.
Record channel	System auto activates motion detection channel(s) to record once an alarm occurs. Please note you need to set motion detect record period and go to Storage-> Schedule to set current channel as schedule record.
Record Delay	System can delay the record for specified time after alarm ended. The value ranges from 10s to 300s.
Alarm out	Enable alarm activation function. You need to select alarm output port so that system can activate corresponding alarm device when an alarm occurs.
Latch	System can delay the alarm output for specified time after an alarm ended. The value ranges from 1s to 300s.
Show message	System can pop up a message to alarm you in the local host screen if you enabled this function.

Parameter	Function
Buzzer	Check the box here to enable this function. The buzzer beeps when an alarm occurs.
Alarm upload	System can upload the alarm signal to the centre (Including alarm centre).
Message	When 3G network connection is OK, system can send out a message when motion detect occurs.
Send Email	If you enabled this function, System can send out an email to alert you when an alarm occurs.
Tour	You need to click setup button to select tour channel. System begins 1-window or multiple-window tour display among the channel(s) you set to record when an alarm occurs. See Figure 5-59.
PTZ Activation	Here you can set PTZ movement when alarm occurs. Such as go to preset X. See Figure 5-58.
Snapshot	Click setup button to select snapshot channel. See Figure 5-60.
Video Matrix	This function is for motion detect only. Check the box here to enable video matrix function. Right now system supports one-channel tour function. System takes "first come and first serve" principle to deal with the activated tour. System will process the new tour when a new alarm occurs after previous alarm ended. Otherwise it restores the previous output status before the alarm activation.

5.8.3.1.2 Video Loss

The video loss interface is shown as in Figure 5-61.

Please note video loss does not support anti-dither, sensitivity, region setup. For rest setups, please refer to chapter 5.8.3.1.1 motion detect for detailed information.

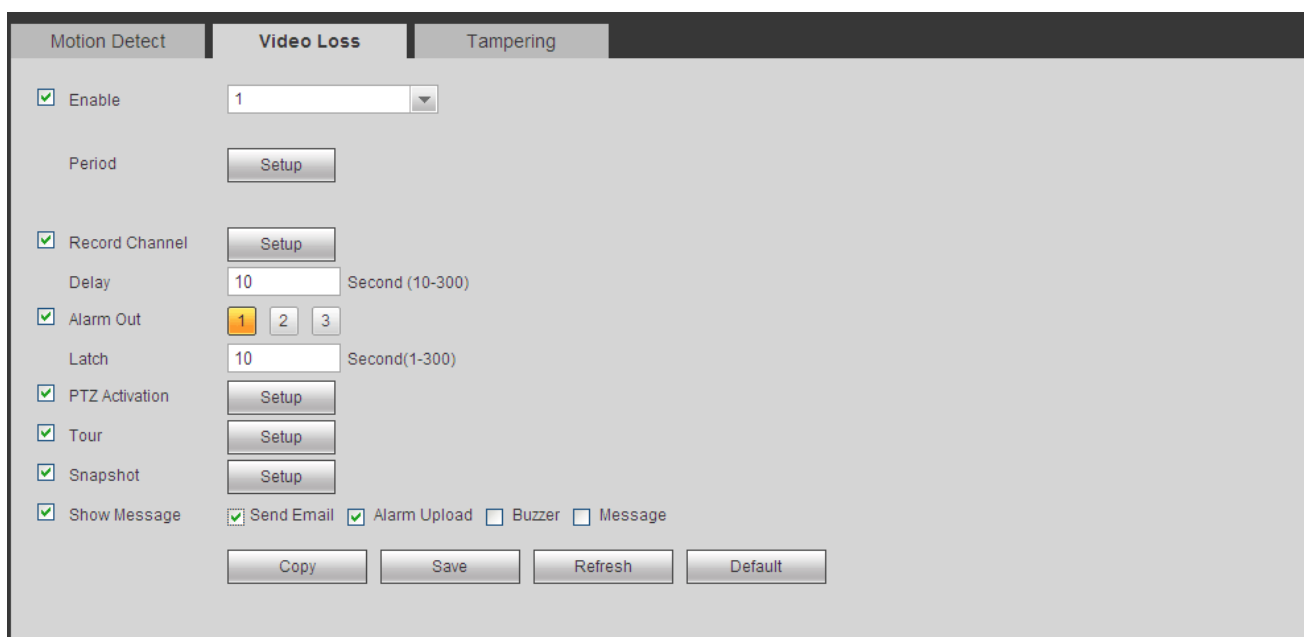

Figure 5-61

5.8.3.1.3 Tampering

The tampering interface is shown as in Figure 5-62.

After analysis video, system can generate a tampering alarm when the detected moving signal reached the sensitivity you set here.

For detailed setups, please refer to chapter 5.8.3.1.1 motion detect for detailed information.

Figure 5-62

5.8.3.2 IVS (Optional)



Please make sure you are connecting to the smart network camera, otherwise you can not use IVS function!

From main menu->Setup->Event->IVS, you can go to the IVS interface. It includes four interfaces: Tripwire/intrusion/object/scene.

5.8.3.2.1 Tripwire

Please make sure you are connecting to the smart network camera, otherwise you can not use IVS function!

From main menu->Setup->Event->IVS->Tripwire, you can see the following interface. See Figure 5-63. System generates an alarm once there is any object crossing the tripwire in the specified direction.

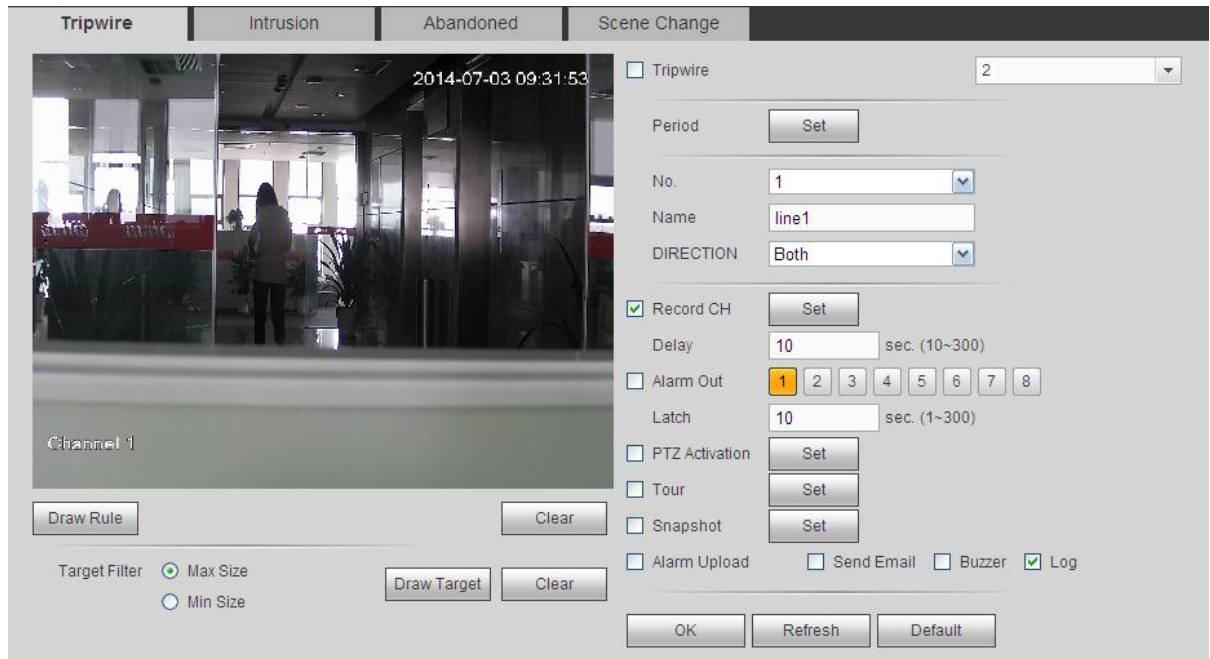

Figure 5-63

Check the Tripwire box to enable tripwire function.

Select SN (Line1/2/3/4) and direction, and then input customized rule name.

- No. and Line1/2/3/4: System supports four tripwires. Each SN stands for one tripwire.
- Direction: There are three options: A->B, B->A, both. System can generate an alarm once there is any object crossing in the specified direction.

Now you can draw a rule. Click Draw rule button and then left click mouse to draw a tripwire. The tripwire can be a direct line, curve or polygon. Right click mouse to complete. See Figure 5-64.

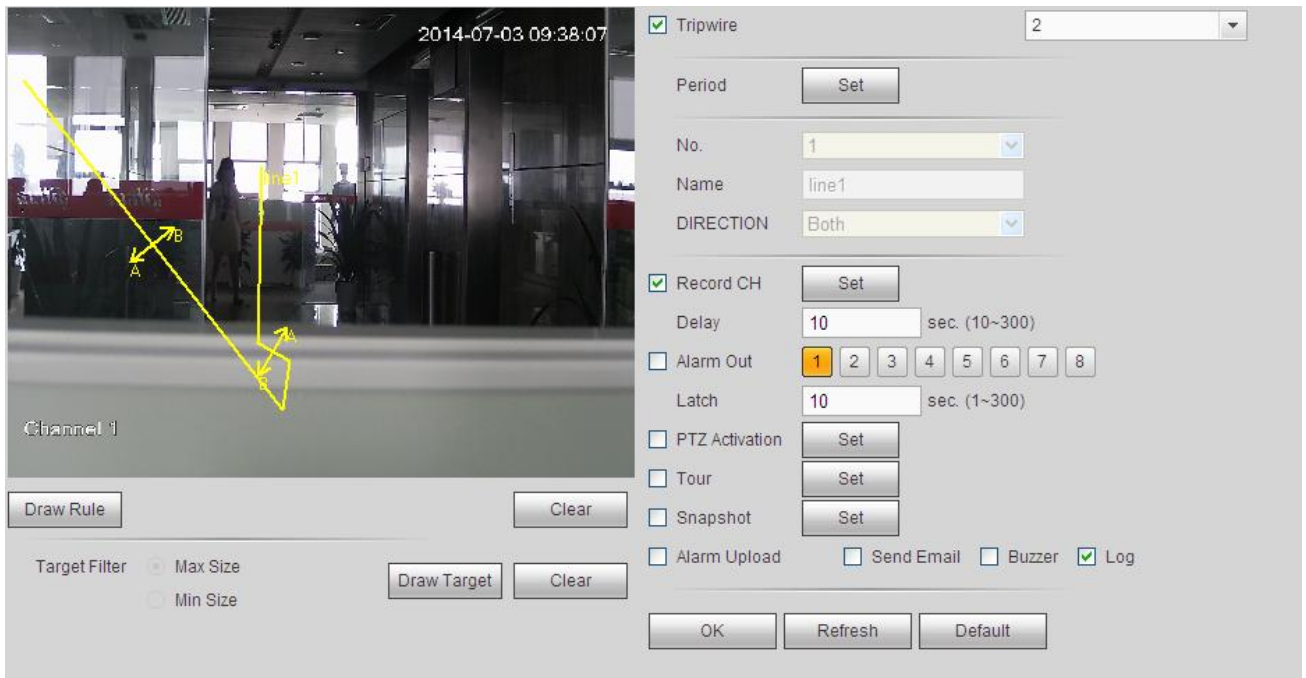

Figure 5-64

Click **Draw Target** to draw filter object. See Figure 5-65.

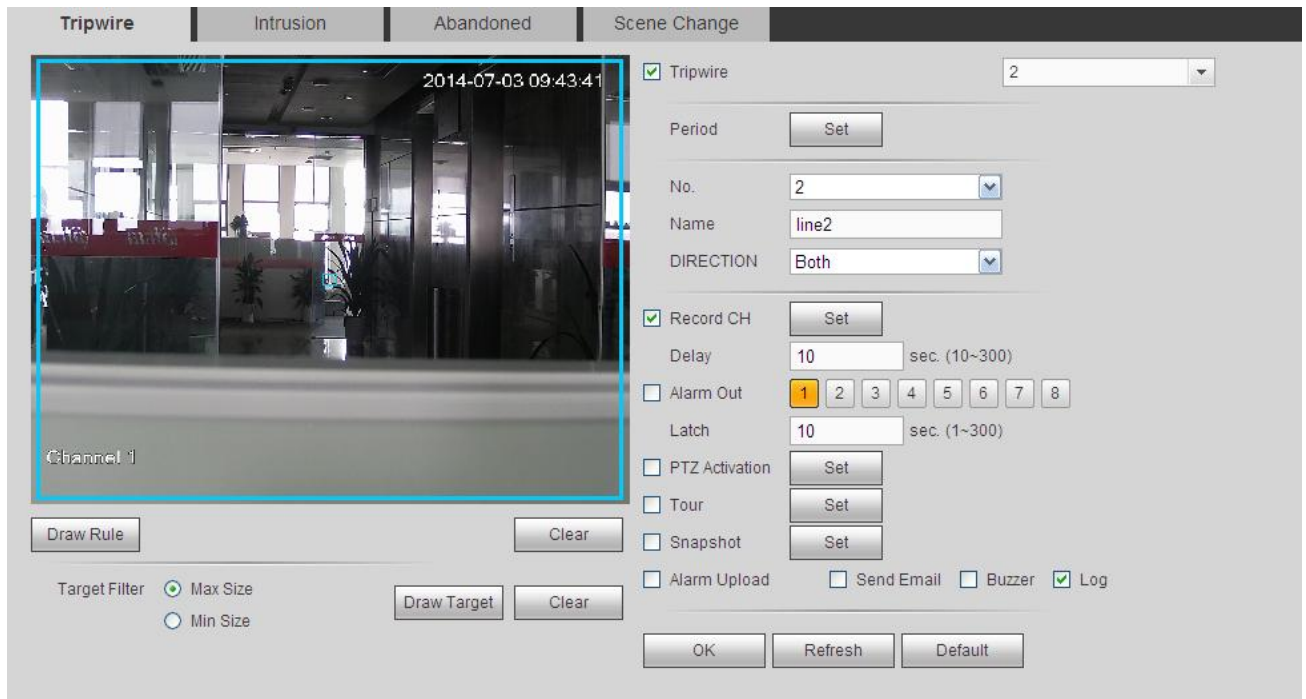

Figure 5-65

Select the blue line and then use mouse to adjust zone size.

Note

Each rule can set two sizes (min size/max size). Once the object is smaller than the min size or larger than the max size, there is no alarm. Please make sure the max size is larger than the min size.

Click Ok to complete the rule setup.

For detailed setups, please refer to chapter 5.8.3.1.1 motion detect for detailed information.

5.8.3.2.2 Intrusion (Cross warning zone)

Please make sure you are connecting to the smart network camera, otherwise you can not use IVS function!

From main menu->Setup->Event->IVS->Intrusion, the intrusion interface is shown as below. See Figure 4-102.

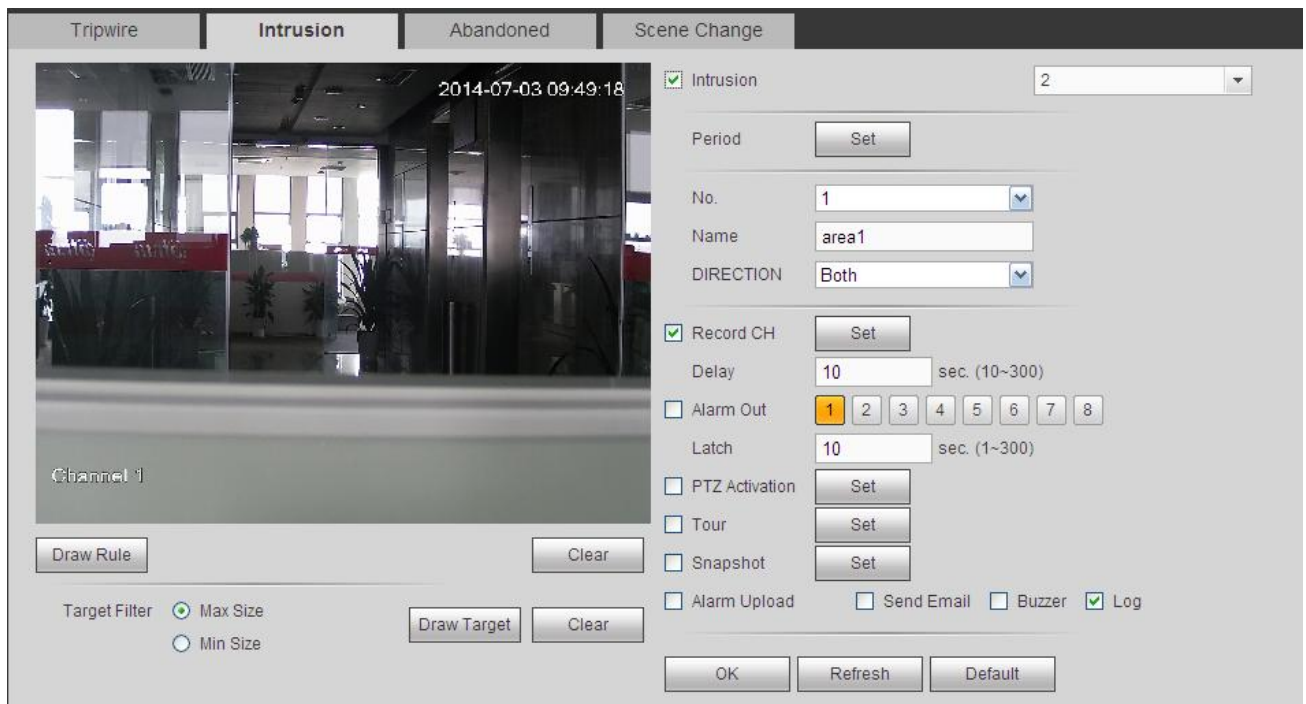

Figure 5-66

Check the Intrusion box to enable intrusion function.

Select SN (Area1/2/3/4) and direction, and then input customized rule name.

- No. and Area1/2/3/4: System supports four zones. Each SN stands for one zone.
- Direction: There are three options: A->B, B->A, both. System can generate an alarm once there is any object enter/exit (Or both) the zone.

Now you can draw a rule. Left click mouse to draw a line first and then right click mouse to draw another line until you draw a rectangle, you can right click mouse to exit.

Click Ok to complete the rule setup.

Click  to draw the zone. See Figure 5-67.

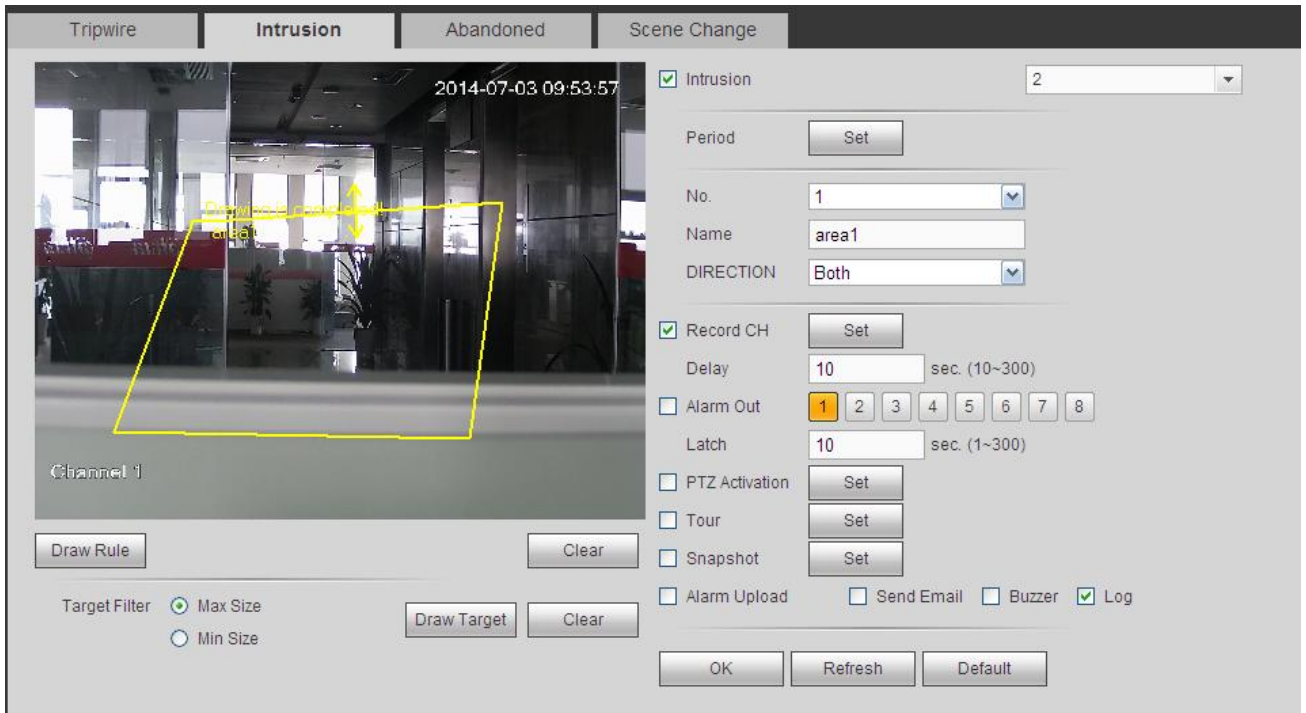

Figure 5-67

For detailed setups, please refer to chapter 5.8.3.1.1 motion detect for detailed information.

5.8.3.2.3 Object Detect

Please make sure you are connecting to the smart network camera, otherwise you can not use IVS function!

For the same channel, the object detect and the intrusion can not be valid at the same time.

From main menu->Setup->Event->IVS->Object, the object interface is shown as below. See Figure 5-68.

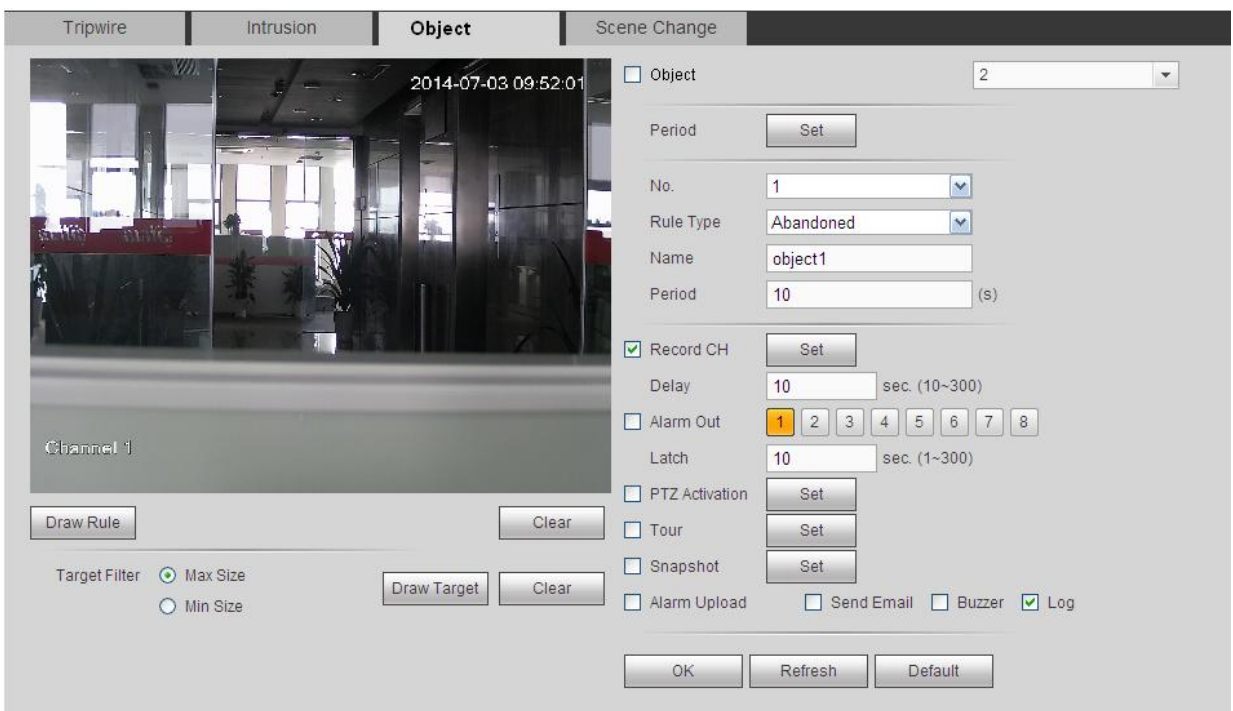



Figure 5-68

Check the Object box to enable object detect function.

Select SN (object1/2/3/4) and rule type, and then input customized rule name.

- No. and Object1/2/3/4: System supports four zones. Each SN stands for one zone.
- Rule type: Please select from the dropdown list. There are two types: Missing object detect/abandoned object detect.
- Period: It refers to the object in/out the zone time.

Click  to draw the rule. See Figure 5-69.

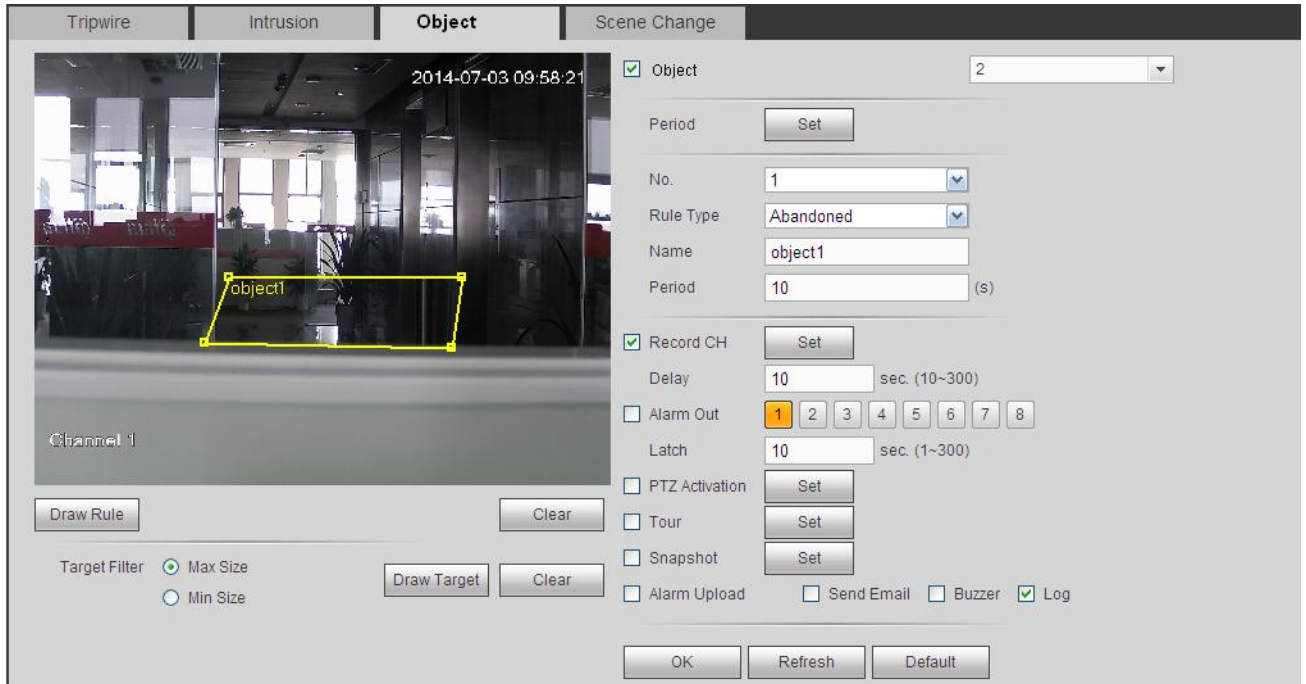

Figure 5-69

Now you can draw a rule. Left click mouse to draw a line, until you draw a rectangle, you can right click mouse.

Click Ok to complete the rule setup.

For detailed setups, please refer to chapter 5.8.3.1.1 motion detect for detailed information.

5.8.3.2.4 Change Scene

Please make sure you are connecting to the smart network camera, otherwise you can not use IVS function!

When the detected scene changes , ,the system can generate an alarm. From main menu->Setup->Event->IVS->Change scene, the interface is shown as in Figure 5-70.

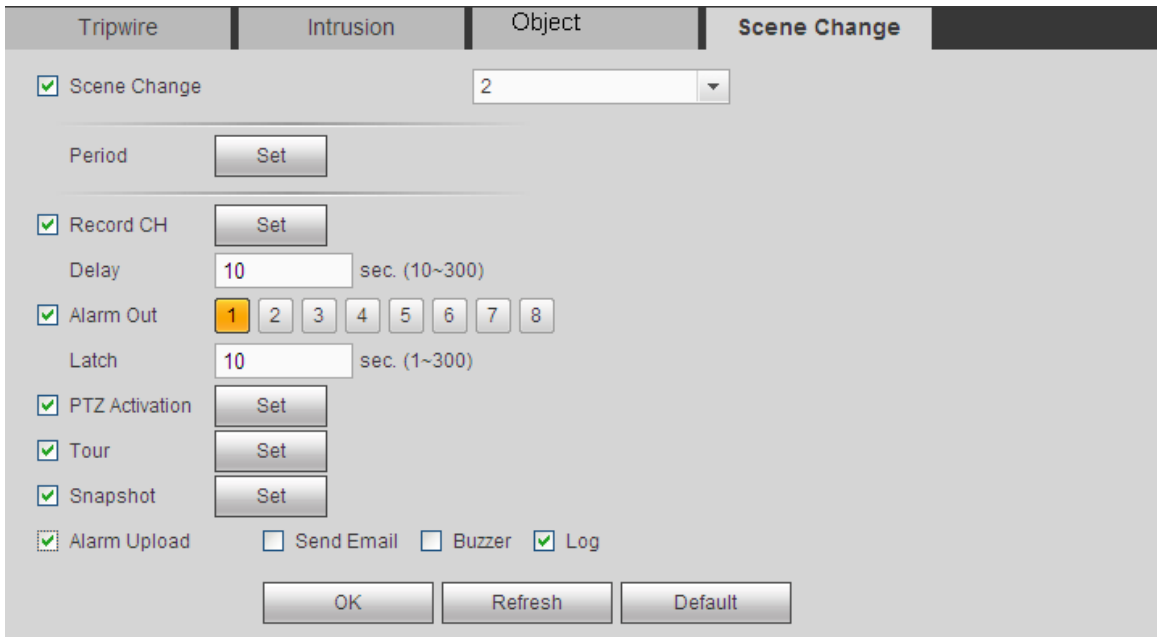

Figure 5-70

For detailed setups, please refer to chapter 5.8.3.1.1 motion detect for detailed information.

5.8.3.3 Face Detect (Optional)

Please make sure you are connecting to the smart network camera, otherwise you can not use IVS function!

When camera detects human face, system can generate an alarm.

From main menu->Setup->Event->Face detect, the interface is shown as in Figure 5-71.

- Enable face boost: Check the box here, system can enhance the human face display pane.
- Sensitivity: System supports 6 levels. The sixth level has the highest sensitivity.

For detailed setups, please refer to chapter 5.8.3.1.1.

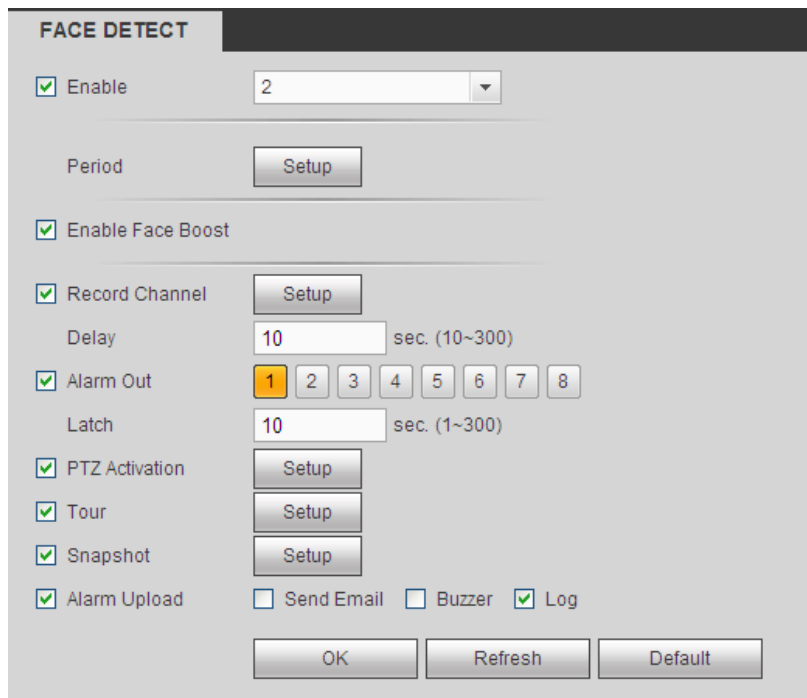

Figure 5-71

5.8.3.4 Audio Detect (Optional)

Please make sure you are connecting to the smart network camera, otherwise you can not use IVS function!

System can generate an alarm once it detect the audio input is abnormal or audio volume changes. From main menu->Setup->Event->Audio detect, you can see an interface shown as in Figure 5-72.

- Input abnormal: Check the box here, system can generate an alarm once the audio input is abnormal.
- Intensity change: Check the box here, system can generate an alarm once the audio volume becomes strong.
- Sensitivity: It refers to the audio recognition sensitivity. The higher the value is, the higher the sensitivity is.
- Threshold: It is to set intensity change threshold. The smaller the value is, the higher the sensitivity is.

For detailed setups, please refer to chapter 5.8.3.1.1 motion detect for detailed information.

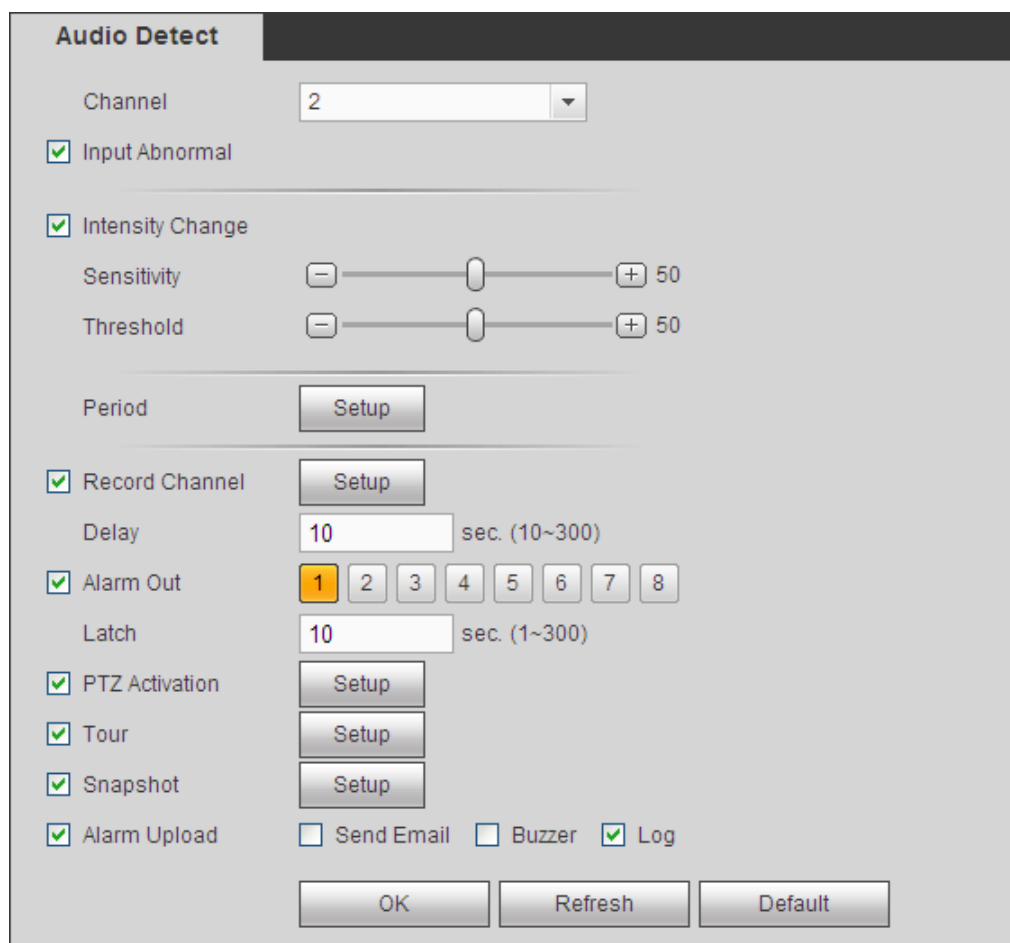

Figure 5-72

5.8.3.5 Alarm

Before operation, please make sure you have properly connected alarm devices such as buzzer. The input mode includes local alarm and network alarm.

5.8.3.5.1 Local Alarm

The local alarm interface is shown as in Figure 5-73. It refers to alarm from the local device.

Local Alarm	Net Alarm	IPC Ext Alarm	IPC Offline Alarm
<input checked="" type="checkbox"/> Enable	1	Alarm Alias	Local Alarm 1
Period	Setup		
Anti-dither	5	Second(5-600)	Type Normal Open
<input checked="" type="checkbox"/> Record Channel	Setup		
Delay	10	Second (10-300)	
<input checked="" type="checkbox"/> Alarm Out	1 2 3		
Latch	10	Second(1-300)	
<input checked="" type="checkbox"/> PTZ Activation	Setup		
<input checked="" type="checkbox"/> Tour	Setup		
<input checked="" type="checkbox"/> Snapshot	Setup		
<input checked="" type="checkbox"/> Show Message	<input type="checkbox"/> Send Email	<input checked="" type="checkbox"/> Alarm Upload	<input type="checkbox"/> Buzzer
	Copy	Save	Refresh Default

Figure 5-73

Setup ✕

Thursday Copy

<input checked="" type="checkbox"/>	00 : 00	-	24 : 00
<input type="checkbox"/>	00 : 00	-	24 : 00
<input type="checkbox"/>	00 : 00	-	24 : 00
<input type="checkbox"/>	00 : 00	-	24 : 00
<input type="checkbox"/>	00 : 00	-	24 : 00
<input type="checkbox"/>	00 : 00	-	24 : 00

Save
Cancel

Figure 5-74

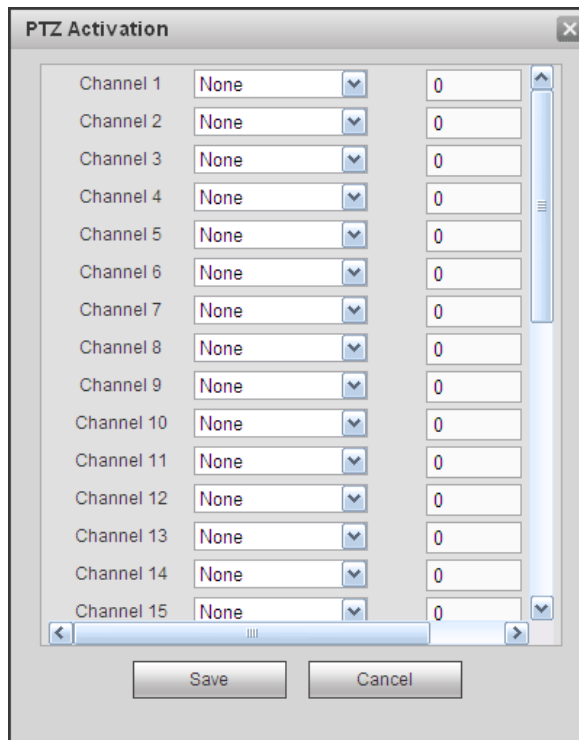

Figure 5-75

Please refer to the following sheet for detailed information.

Parameter	Function
Enable	You need to check the box to enable this function. Please select a channel from the dropdown list.
Period	This function becomes activated in the specified periods. There are six periods in one day. Please draw a circle to enable corresponding period. Select date. If you do not select, current setup applies to today only. You can select all week column to apply to the whole week. Click OK button, system goes back to local alarm interface, please click save button to exit.
Anti-dither	System only memorizes one event during the anti-dither period. The value ranges from 5s to 600s.
Sensor type	There are two options: NO/NC.
Record channel	System auto activates motion detection channel(s) to record once an alarm occurs. Please note you need to set alarm record period and go to Storage-> Schedule to set current channel as schedule record.
Record Delay	System can delay the record for specified time after alarm ended. The value ranges from 10s to 300s.
Alarm out	Enable alarm activation function. You need to select alarm output port so that system can activate corresponding alarm device when an alarm occurs.
Latch	System can delay the alarm output for specified time after an alarm ended. The value ranges from 1s to 300s.

Parameter	Function
Show message	System can pop up a message to alarm you in the local host screen if you enabled this function.
Buzzer	Check the box here to enable this function. The buzzer beeps when an alarm occurs.
Alarm upload	System can upload the alarm signal to the centre (Including alarm centre).
Send Email	If you enabled this function, System can send out an email to alert you when an alarm occurs.
Tour	You need to click setup button to select tour channel. System begins 1-window or multiple-window tour display among the channel(s) you set to record when an alarm occurs. See Figure 5-59.
PTZ Activation	Here you can set PTZ movement when alarm occurs. Such as go to preset X. See Figure 5-75.
Snapshot	Click setup button to select snapshot channel. See Figure 5-60.

5.8.3.5.2 Net Alarm

The network alarm interface is shown as in Figure 5-76.

Network alarm refers to the alarm signal from the network. System does not anti-dither and sensor type setup. For setup information, please refer to chapter 5.8.3.5.1.

Figure 5-76

5.8.3.5.3 IPC external alarm

The IPC external alarm interface is shown as in Figure 5-77.

Network alarm refers to the alarm signal from the network. System does not anti-dither and sensor type

setup. For setup information, please refer to chapter 5.8.3.5.1.

Figure 5-77

5.8.3.5.4 IPC Offline Alarm

The IPC offline alarm interface is shown as in Figure 5-78.

System can generate an alarm once the network camera is offline. For setup information, please refer to chapter 5.8.3.5.1.

Figure 5-78

5.8.3.6 Abnormality

It includes six types: No disk, disk error, disks no space, disconnect, IP conflict, MAC conflict. See Figure 5-79 through Figure 5-84.

Figure 5-79

Figure 5-80

Figure 5-81

Figure 5-82

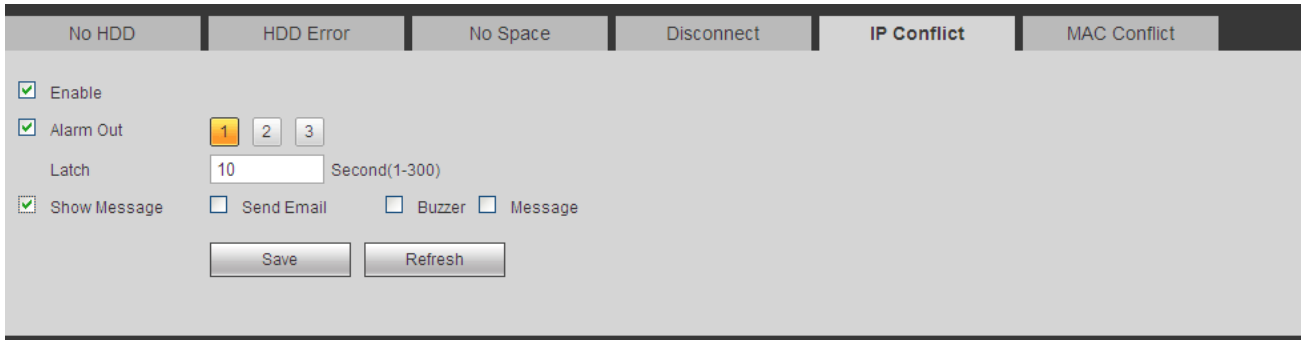

Figure 5-83

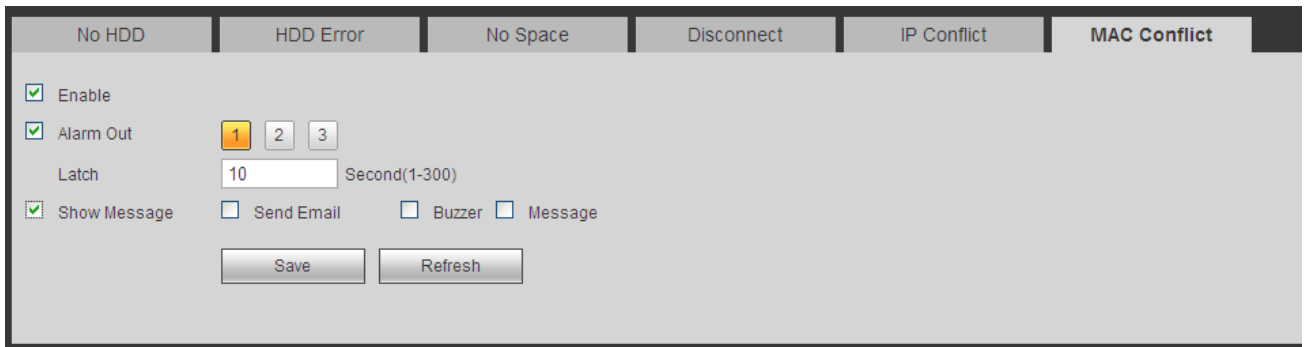

Figure 5-84

Please refer to the following sheet for detailed information.

Parameter	Function
Event Type	The abnormal events include: No disk, disk error, disk no space, net disconnection, IP conflict and MAC conflict. You can set one or more items here. Less than: You can set the minimum percentage value here (For disk not space only). The device can alarm when capacity is not sufficient. You need to draw a circle to enable this function.
Enable	Check the box here to enable selected function.
Alarm Out	Please select corresponding alarm output channel when an alarm occurs. You need to check the box to enable this function.
Latch	The alarm output can delay for the specified time after an alarm stops. The value ranges from 1s to 300s.
Show message	System can pop up a message to alarm you in the local host screen if you enabled this function.
Alarm upload	System can upload the alarm signal to the centre (Including alarm centre).
Send Email	If you enabled this function, System can send out an email to alert you when an alarm occurs.

Parameter	Function
Buzzer	Check the box here to enable this function. The buzzer beeps when an alarm occurs.

5.8.4 Storage

5.8.4.1 Schedule

In this interfaces, you can add or remove the schedule record setup. See Figure 5-85.

There are four record modes: general (auto), motion detect, alarm and MD&alarm. There are six periods in one day.

You can view the current time period setup from the color bar.

- Green color stands for the general record/snapshot.
- Yellow color stands for the motion detect record/snapshot..
- Red color stands for the alarm record/snapshot.
- Blue color stands for MD&alarm record/snapshot.

Figure 5-85

Figure 5-86

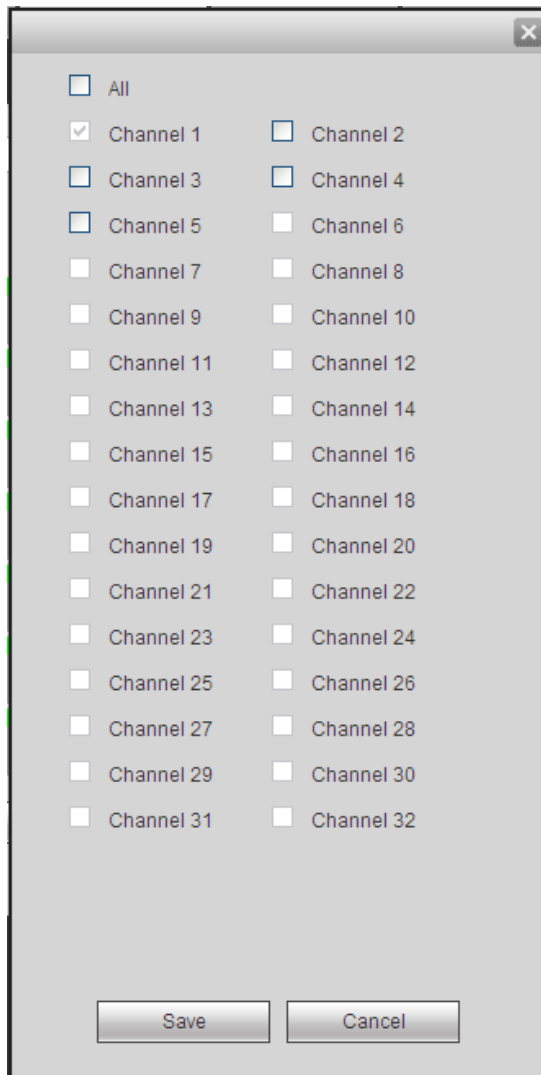

Figure 5-87

Please refer to the following sheet for detailed information.

Parameter	Function
Channel	Please select a channel from the dropdown list.
Pre-record	Please input pre-record time here. The value ranges from 0 to 30.
Redundancy	Check the box here to enable redundancy function. Please note this function is null if there is only one HDD.
Snapshot	Check the box here to enable snapshot function.
Holiday	Check the box here to enable holiday function.
Setup	Click the Setup button, you can set record period. See Figure 5-86. There are six periods in one day. If you do not check the date at the bottom of the interface, current setup is for today only. Please click Save button and then exit.
Copy	Copy function allows you to copy one channel setup to another. After setting in channel, click Copy button, you can go to interface Figure 5-87. You can see current channel name is grey such as channel 1. Now you can select the channel you want to paste such as channel

Parameter	Function
	5/6/7. If you want to save current setup of channel 1 to all channels, you can click the first box "ALL". Click the OK button to save current copy setup. Click the OK button in the Encode interface, the copy function succeeded.

5.8.4.2 HDD Manager

5.8.4.2.1 Local Storage

The local interface is shown as in Figure 5-88. Here you can see HDD information. You can also operate the read-only, read-write, redundancy (if there are more than on HDD) and format operation.

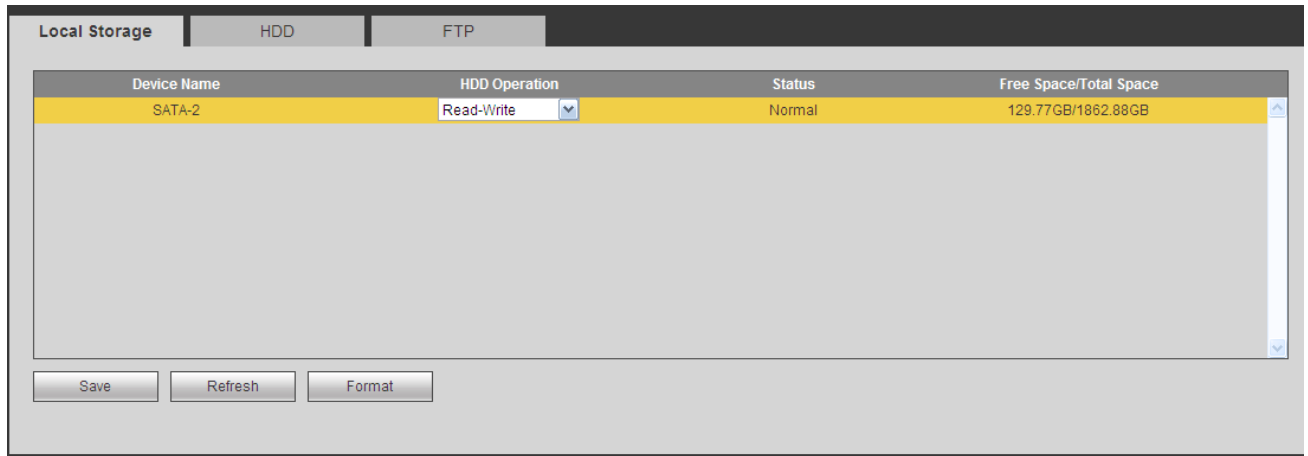

Figure 5-88

5.8.4.2.2 HDD

The HDD interface is to set HDD group. See Figure 5-89.



Figure 5-89

5.8.4.2.3 FTP

The FTP interface is to set FTP information. See Figure 5-90.

Please set the FTP as your remote storage location. System can save record file or snapshot picture to the FTP once the network is offline or malfunction.

Figure 5-90

5.8.4.3 Record Control

The interface is shown as in Figure 5-91.

Figure 5-91

Please refer to the following sheet for detailed information.

Parameter	Function
Channel	Here you can view channel number. The number displayed here is the max channel amount of your device.
Status	There are three statuses: schedule, manual and stop.
Schedule	System enables auto record function as you set in record schedule setup (general, motion detect and alarm).

Manual	It has the highest priority. Enable corresponding channel to record no matter what period applied in the record setup.
Stop	Stop current channel record no matter what period applied in the record setup.
Start all/ stop all	Check the corresponding All button, you can enable or disable all channels record.

5.8.4.4 RAID Manager

Important

Please make sure your purchased product support the RAID function, otherwise you can not see the following interface.

5.8.4.4.1 RAID Config

It is for you to manage RAID HDD. It can display RAID name, type, free space, total space, status and etc. Here you can add/delete RAID HDD.

Click Add button to select RAID type and then select HDDs, click OK button to add. See Figure 5-92.

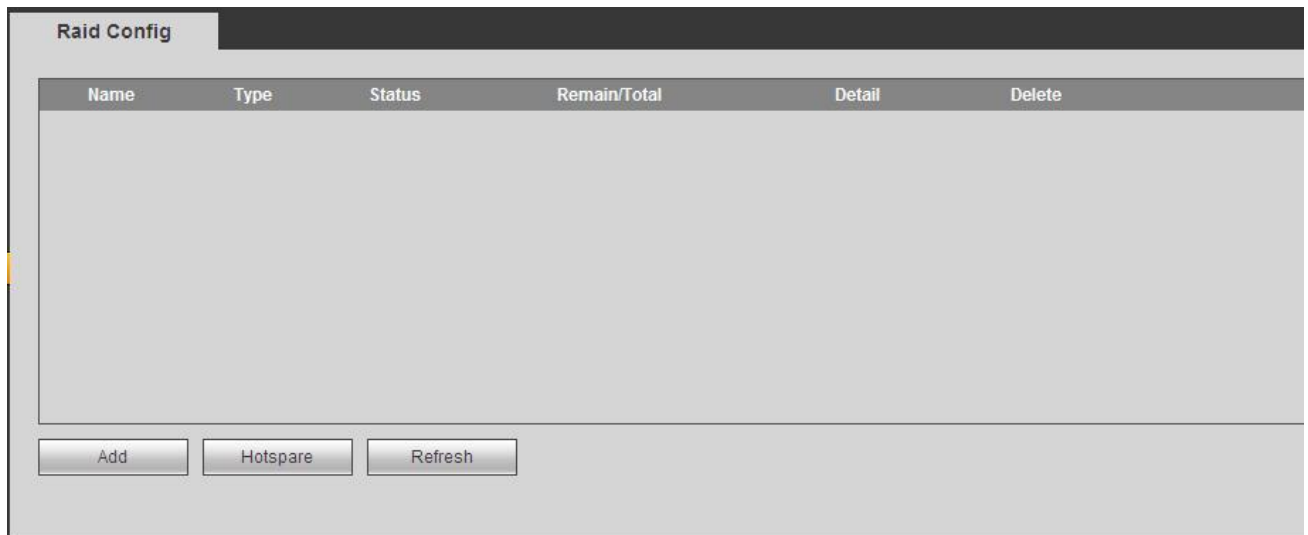

Figure 5-92

5.8.4.4.2 Hotspare disks

In Figure 5-92, click hotspare button, you can add the hot spare HDD. See Figure 5-93. The type includes two options:

- Global: It is global hotspare disk. When any RAID becomes degrading, it can replace and build the RAID.
- Local: It is local hotspare disk. When the specified RAID becomes degrading, it can replace and build the RAID.

Select a hot spare device and then click Delete button. Click Apply button to delete.

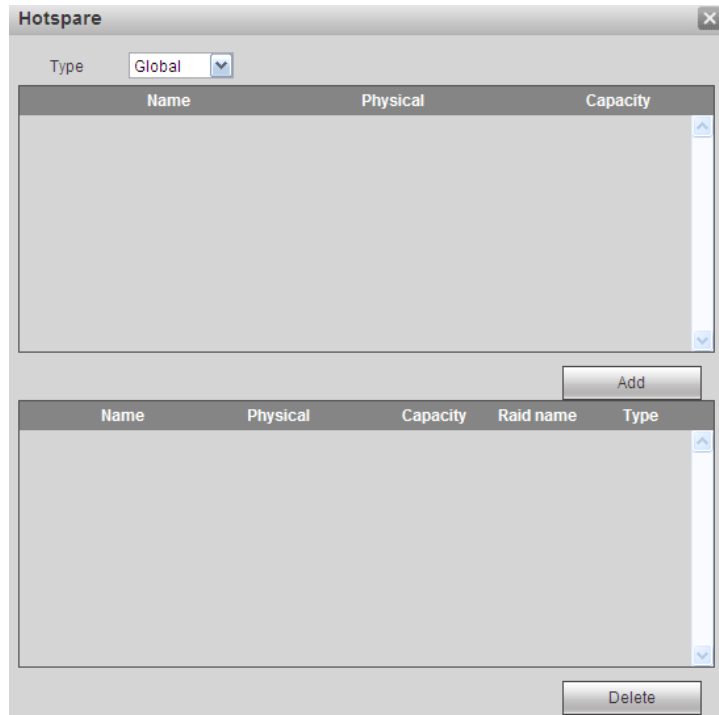

Figure 5-93

5.8.4.5 Storage

5.8.4.5.1 Main Stream

The main stream interface is shown as in Figure 5-94. Here you can set corresponding HDD group to save main stream.

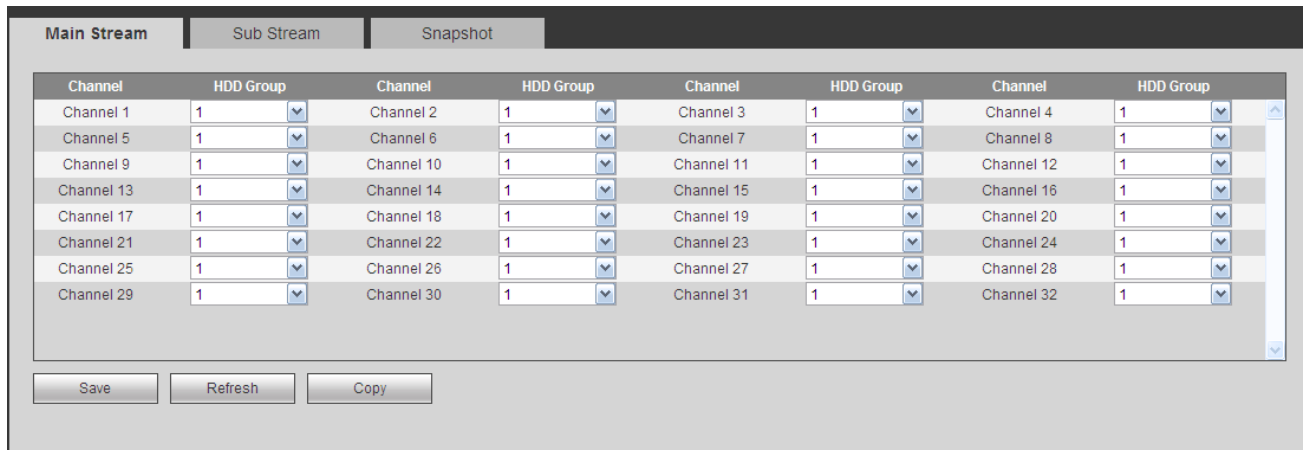

Figure 5-94

5.8.4.5.2 Sub Stream

The sub stream interface is shown as in Figure 5-95.

Here you can set corresponding HDD group to save sub stream.

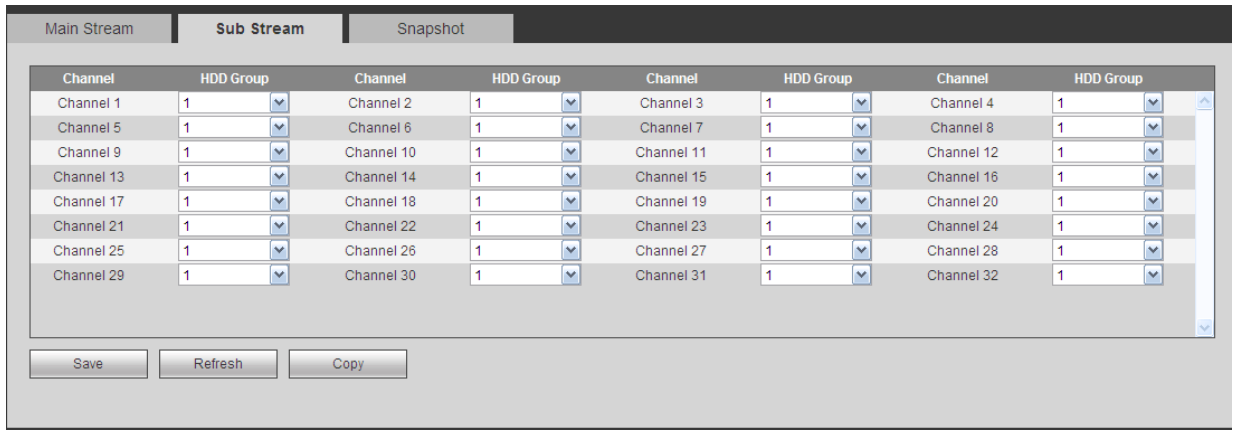

Figure 5-95

5.8.4.5.3 Snapshot

The snapshot interface is shown as in Figure 5-96. Here you can set corresponding HDD group to save snapshot picture.

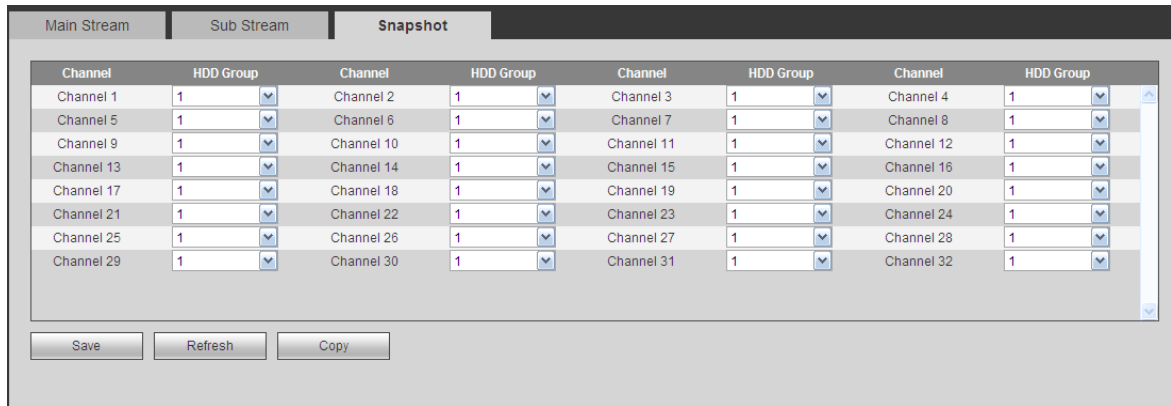

Figure 5-96

5.8.5 Setting

5.8.5.1 General

The general interface includes general, date/time and holiday setup.

5.8.5.1.1 General

The general interface is shown as in Figure 5-97.

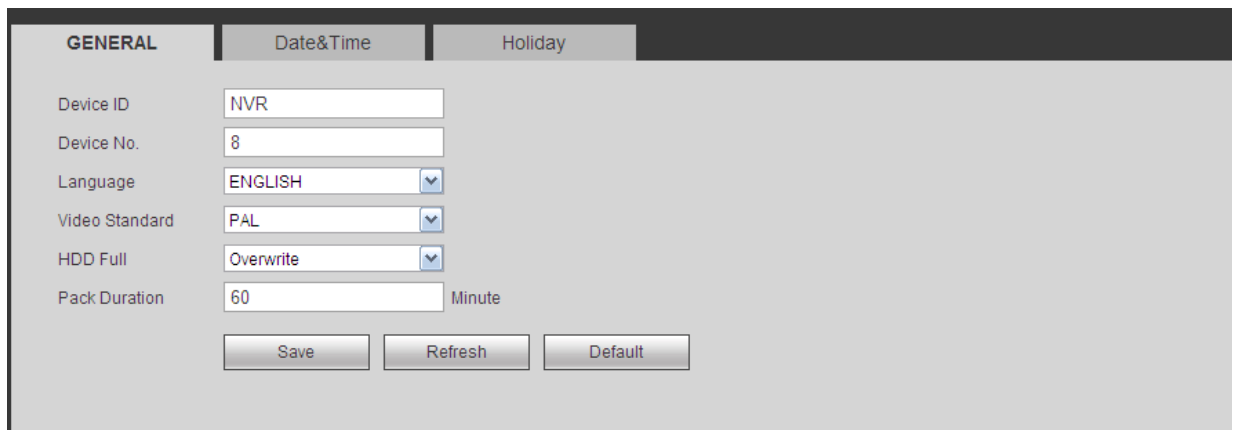

Figure 5-97

Please refer to the following sheet for detailed information.

Parameter	Function
Device ID	It is to set device name.
Device No.	It is device channel number.
Language	You can select the language from the dropdown list. Please note the device needs to reboot to get the modification activated.
Video Standard	This is to display video standard such as PAL.
HDD full	Here is for you to select working mode when hard disk is full. There are two options: stop recording or rewrite. If current working HDD is overwritten or the current HDD is full while the next HDD is no empty, then system stops recording, If the current HDD is full and then next HDD is not empty, then system overwrites the previous files.
Pack duration	Here is for you to specify record duration. The value ranges from 1 to 120 minutes. Default value is 60 minutes.

5.8.5.1.2 Date and time

The date and time interface is shown as in Figure 5-98

Figure 5-98

Please refer to the following sheet for detailed information.

Parameter	Function
Date format	Here you can select date format from the dropdown list.

Time Format	There are two options: 24-H and 12-H.
Time zone	The time zone of the device.
System time	It is to set system time. It becomes valid after you set.
Sync PC	You can click this button to save the system time as your PC current time.
DST	Here you can set day night save time begin time and end time. You can set according to the date format or according to the week format.
NTP	You can check the box to enable NTP function.
NTP server	You can set the time server address.
Port	It is to set the time server port.
Interval	It is to set the sync periods between the device and the time server.

5.8.5.1.3 Holiday Setup

Holiday setup interface is shown as in Figure 5-99.

Here you can click Add holidays box to add a new holiday and then click Save button to save.

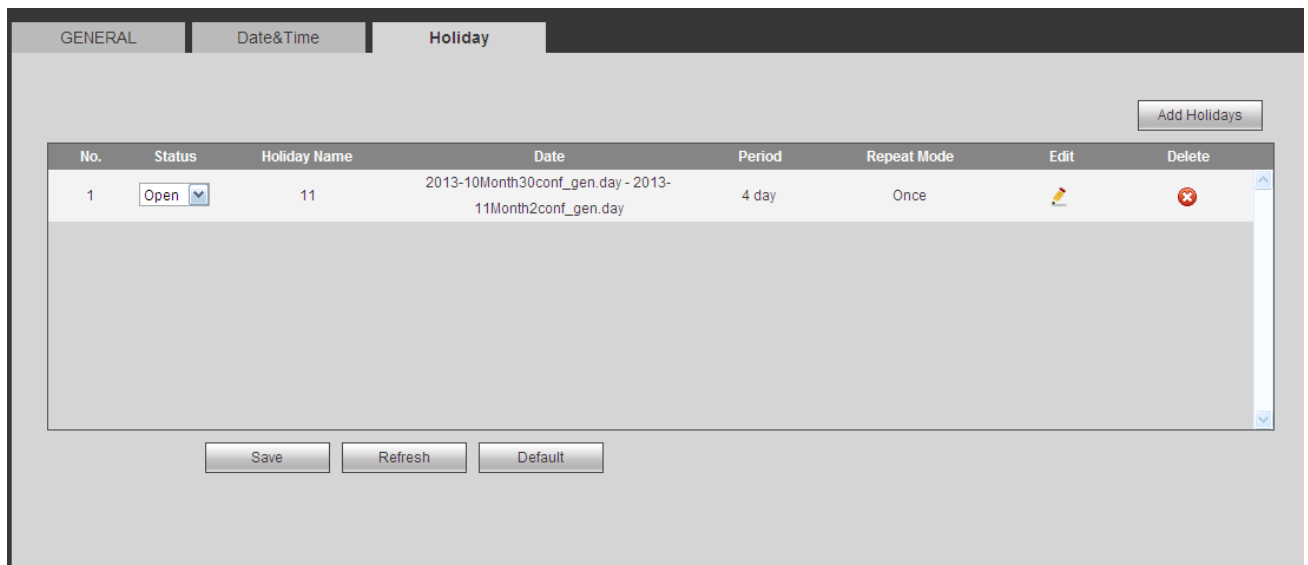

Figure 5-99

5.8.5.2 Account

Note:

- For the character in the following user name or the user group name, system max supports 6-digits. The space in the front or at the end of the string is null. The valid string includes: character, number, and underline.
- The user amount default setup is 64 and the group amount default setup is 20. The factory default setup includes two levels: user and admin. You can set the corresponding group and then set the rights for the respective user in the specified groups.
- User management adopts group/user modes. The user name and the group name shall be unique. One user shall be included in only one group.

5.8.5.2.1 User name

In this interface you can add/remove user and modify user name. See Figure 5-100.

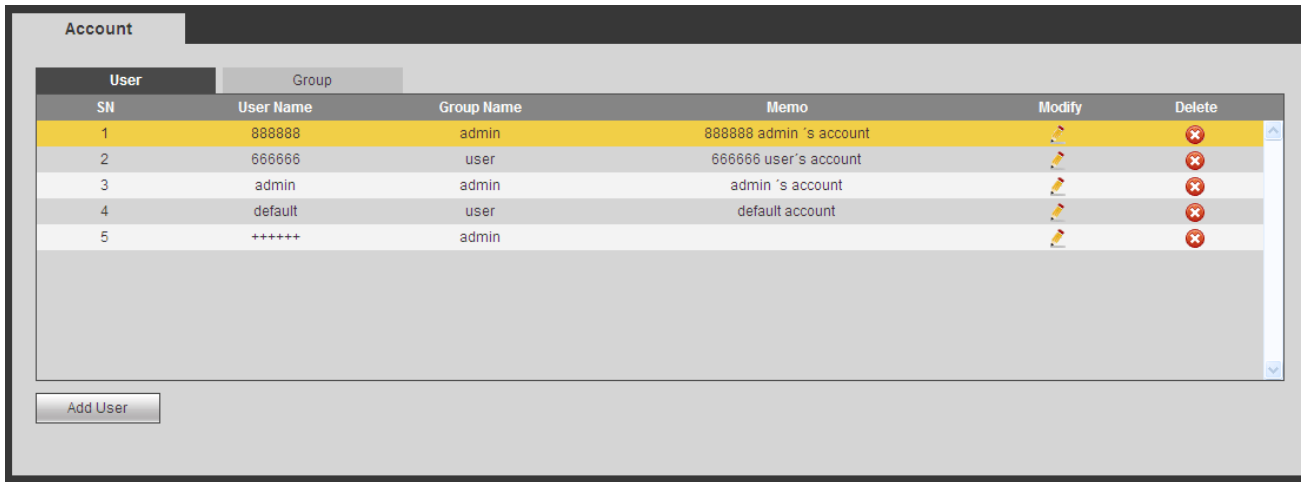

Figure 5-100

Add user: It is to add a name to group and set the user rights. See Figure 5-101.

There are three default users: admin/888888 and hidden user “default”.

Hidden user “default” is for system interior use only and can not be deleted. When there is no login user, hidden user “default” automatically login. You can set some rights such as monitor for this user so that you can view some channel view without login.

Here you can input the user name and password and then select one group for current user.

Please note the user rights shall not exceed the group right setup.

For convenient setup, please make sure the general user has the lower rights setup than the admin.

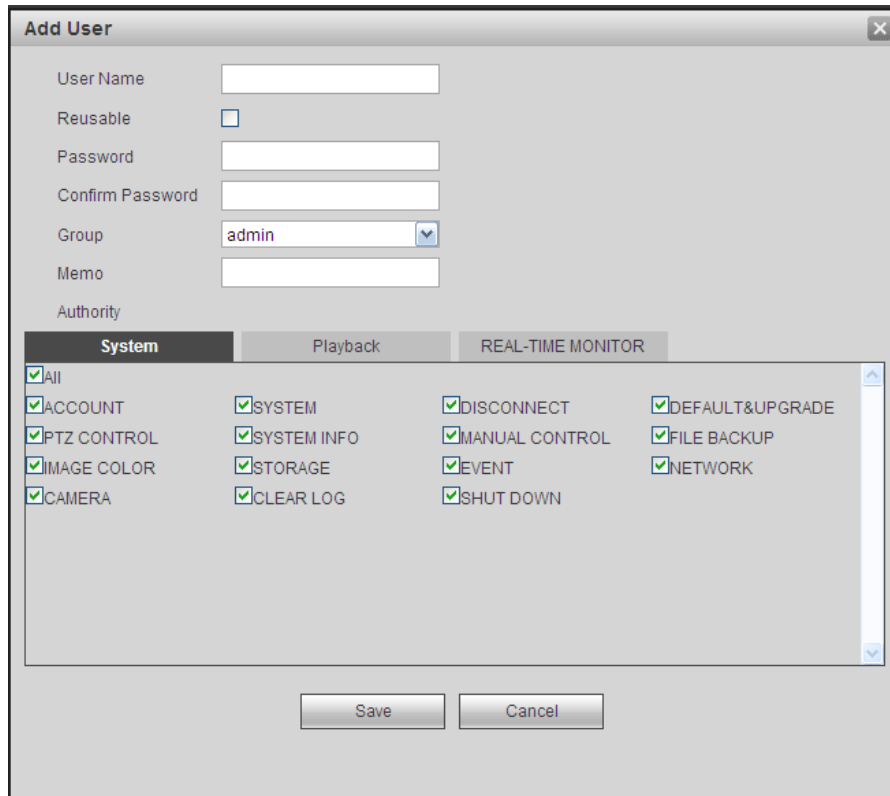

Figure 5-101

Modify user

It is to modify the user property, belonging group, password and rights. See Figure 5-102.

Modify password

It is to modify the user password. You need to input the old password and then input the new password twice to confirm the new setup. Please click the OK button to save.

Please note, the password ranges from 1-digit to 6-digit. It shall include the number only. For the user of the account rights, he can modify the password of other users.

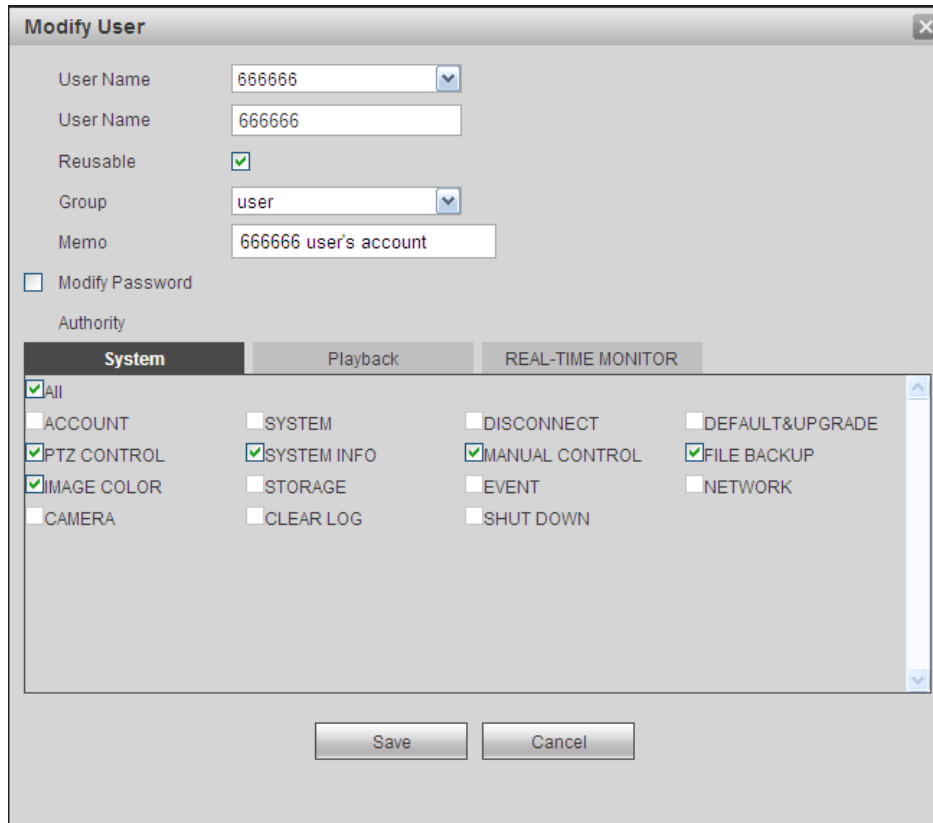

Figure 5-102

5.8.5.2.2 Group

The group management interface can add/remove group, modify group password and etc.

The interface is shown as in Figure 5-103.

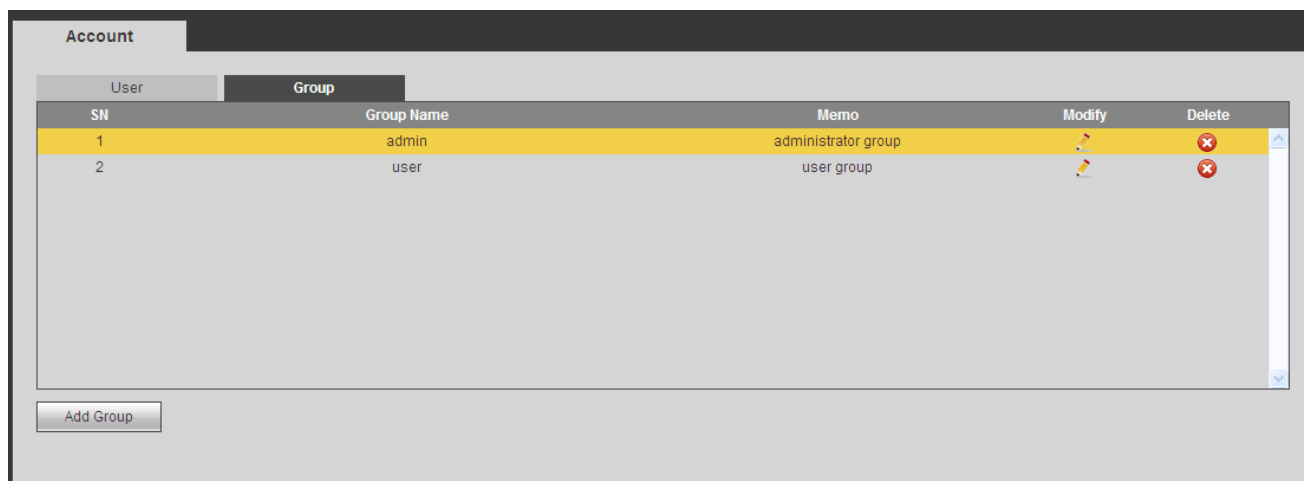

Figure 5-103

Add group: It is to add group and set its corresponding rights. See Figure 5-104.

Please input the group name and then check the box to select the corresponding rights. It includes: shutdown/reboot device, live view, record control, PTZ control and etc.

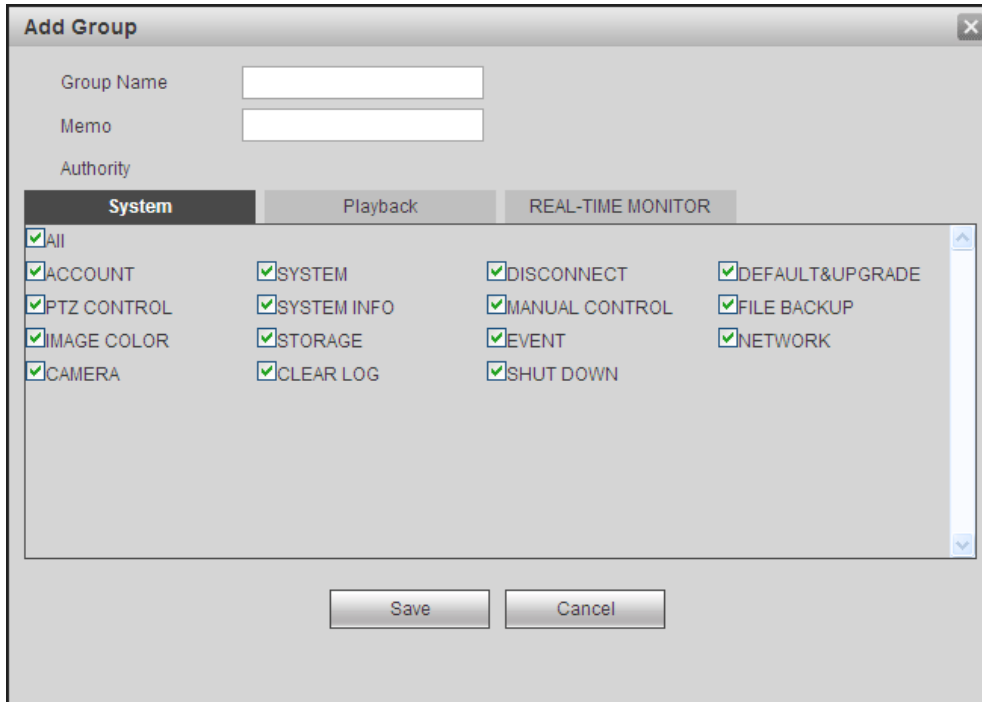

Figure 5-104

Modify group

Click the modify group button, you can see an interface is shown as in Figure 5-105.

Here you can modify group information such as remarks and rights.

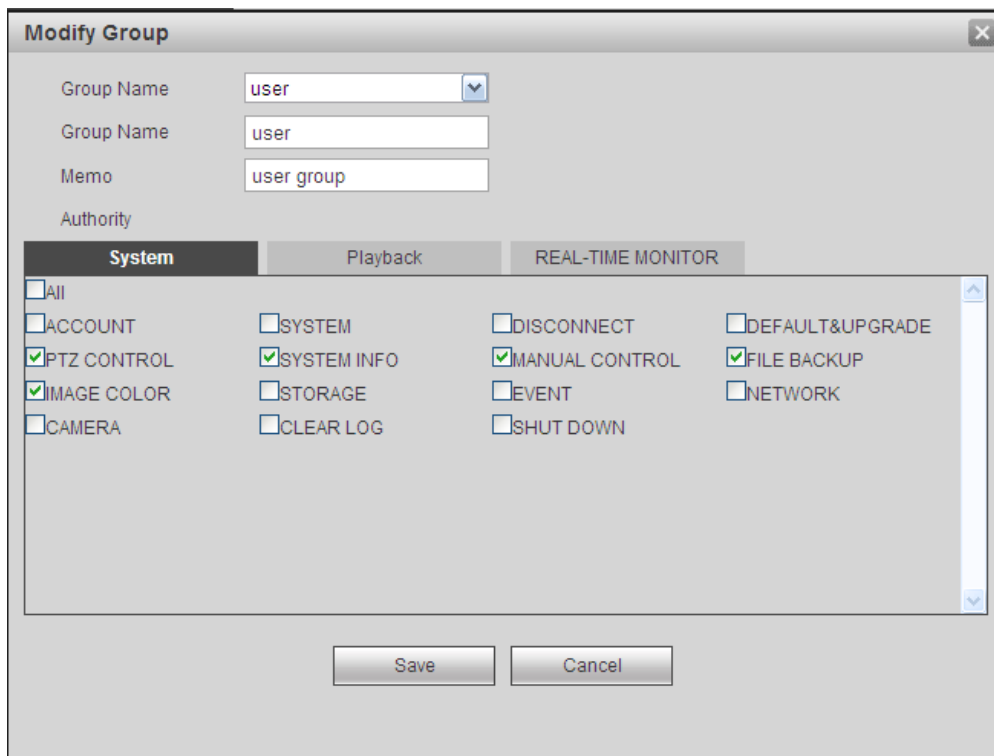

Figure 5-105

5.8.5.3 Display

Display interface includes GUI, TV adjust, Tour and zero-channel encoding.

5.8.5.3.1 Display

Here you can set background color and transparency level. See Figure 5-106.

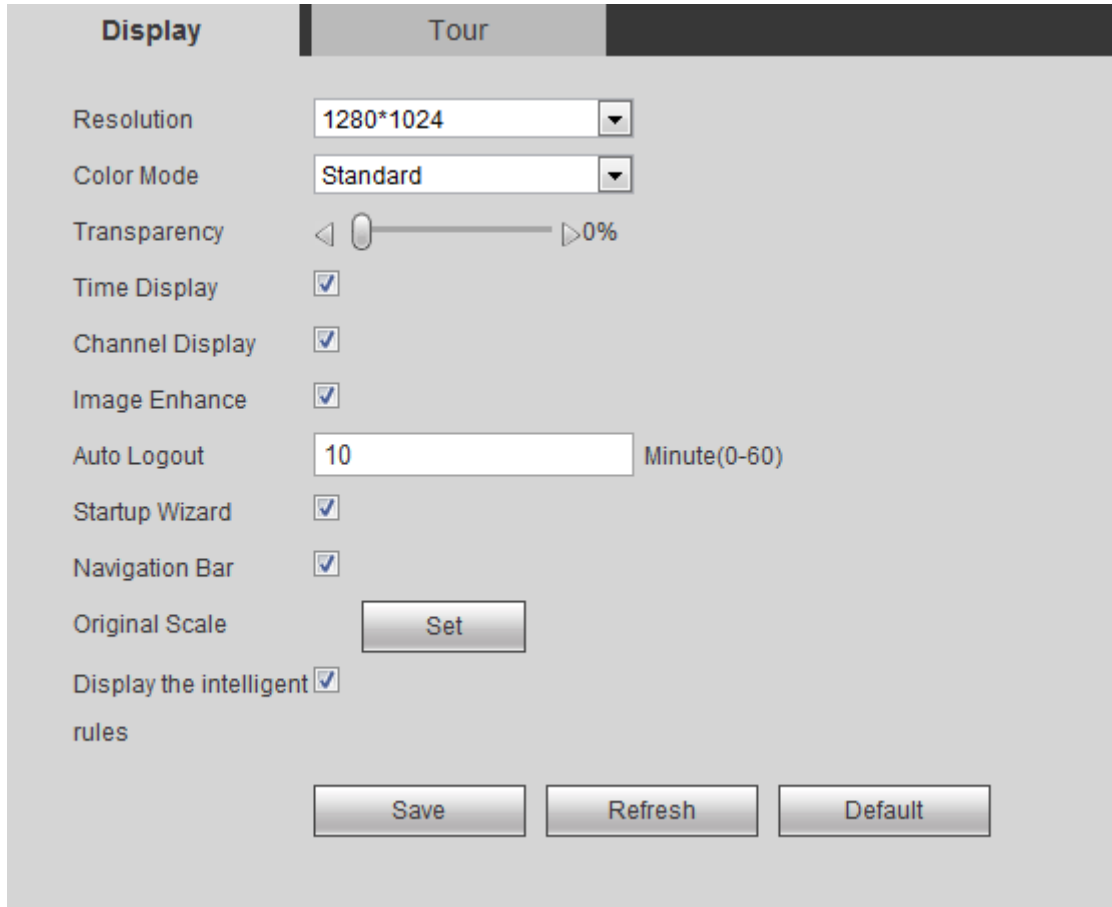

Figure 5-106

Please refer to the following sheet for detailed information.

Parameter	Function
Resolution	There are four options: 1920×1080, 1280×1024(default), 1280×720, 1024×768. Please note the system needs to reboot to activate current setup.
Color mode	Please select from the dropdown list.
Transparency	Here is for you to adjust transparency. The value ranges from 128 to 255.
Time title/channel title	Check the box here, you can view system time and channel number on the monitor video.
Image enhance	Check the box; you can optimize the margin of the preview video.
Startup wizard	Once you check the box here, system will go to the startup wizard directly when the system restarts the next time. Otherwise, it will go to the login interface.
Navigation bar	Check the box here, system displays the navigation bar on the interface.

Original scale	Click the Set button to select a channel, it can restore original scale.
Auto logout	Here is for you to set auto logout interval once login user remains inactive for a specified time. Value ranges from 0 to 60 minutes. 0 means there is no standby time. After the auto logout, the user needs to input user name and password to login again.
Display intelligent rule(s)	Check the box to enable IVS function, system can display IVS rule on the preview interface.

5.8.5.3.2 Tour

The tour interface is shown as in Figure 5-107. Here you can set tour interval, split mode, motion detect tour and alarm tour mode.

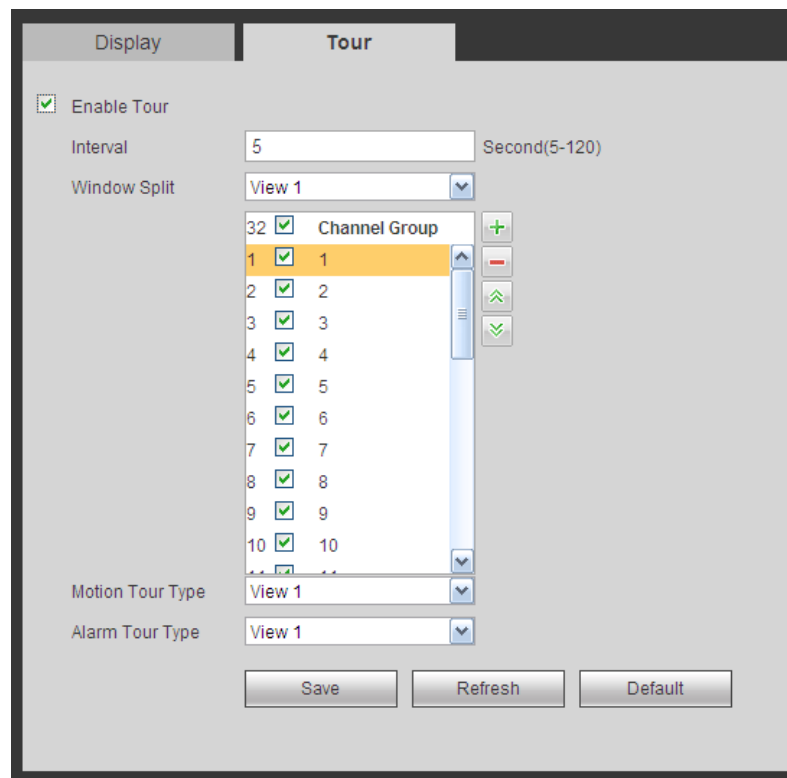

Figure 5-107

Please refer to the following sheet for detailed information.

Parameter	Function
Enable tour	Check the box here to enable tour function.
Interval	Here is for you to adjust transparency. The value ranges from 5 to 120s. The default setup is 5s.
Split	Here you can set window mode and channel group. System can support 1/4/8/9/16/25/36-window according to device channel amount.
Motion tour/Alarm tour	Here you can set motion detect tour/alarm tour window mode. System supports 1/8-window now.

5.8.5.4 Alarm Out

The alarm output interface is shown as below. See Figure 5-108
Here you can set alarm output mode: auto/manual/stop.



Figure 5-108

5.8.5.5 Default

The default setup interface is shown as in Figure 5-109.

Here you can select Network/Event/Storage/Setting/Camera. Or you can check the All box to select all items.

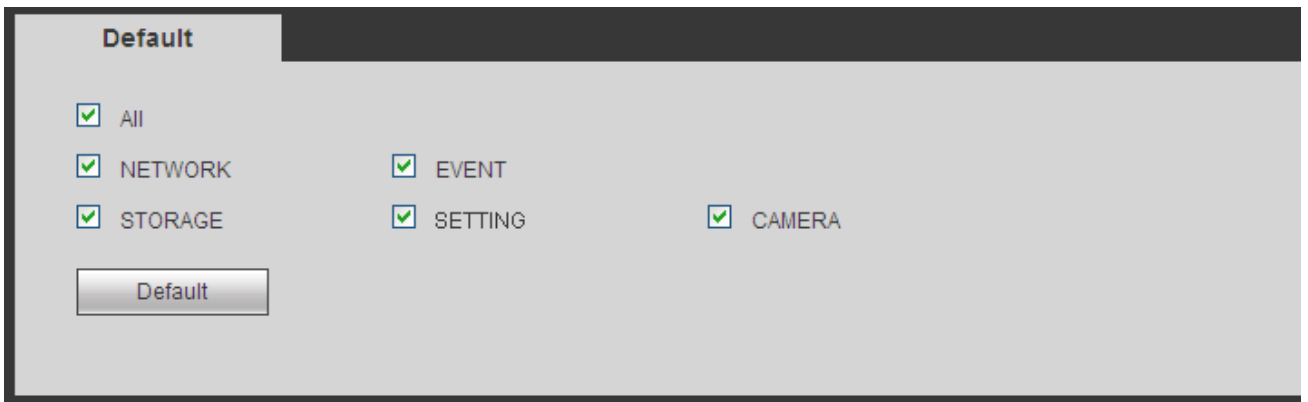

Figure 5-109

5.8.5.6 Import/Export

The interface is shown as in Figure 5-110. This interface is for you to export or import the configuration files.

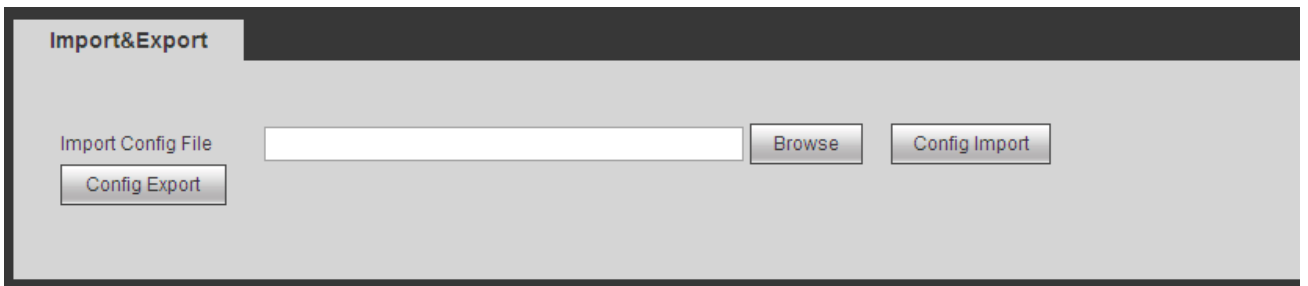

Figure 5-110

Please refer to the following sheet for detailed information.

Parameter	Function
Browse	Click to select import file.
Import	It is to import the local setup files to the system.
Export	It is to export the corresponding WEB setup to your local PC.

5.8.5.7 Auto maintain

The auto maintain interface is shown as in Figure 5-111.

Here you can select auto reboot and auto delete old files interval from the dropdown list.

If you want to use the auto delete old files function, you need to set the file period.

Click Manual reboot button, you can restart device manually.

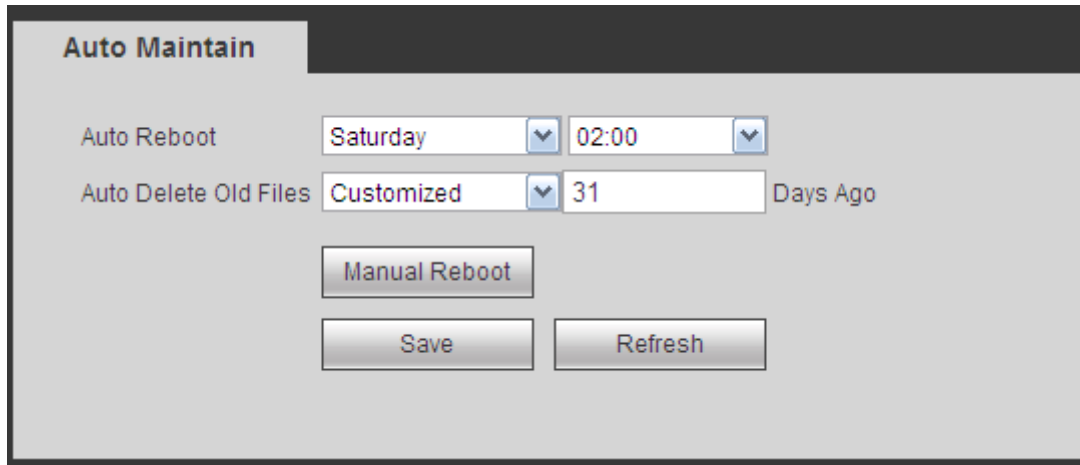

Figure 5-111

5.8.5.8 Upgrade

The upgrade interface is shown as in Figure 5-112.

Please select the upgrade file and then click the update button to begin update. Please note the file name shall be as *.bin. During the upgrade process, do not unplug the power cable, network cable, or shutdown the device.

Important

Improper upgrade program may result in device malfunction! Please make sure the operation is operated under the supervision of the professional engineer!



Figure 5-112

5.8.5.9 RS232

The RS232 interface is shown as in Figure 5-113.

Figure 5-113

Please refer to the following sheet for detailed information.

Parameter	Function
Protocol	Select the corresponding dome protocol. Default setup is console.
Baud Rate	Select the baud rate. Default setup is 115200.
Data Bit	The value ranges from 5 to 8. Default setup is 8.
Stop bit	There are two options: 1/2. Default setup is 1.
Parity	There are five options: none/odd/even/space/mark. Default setup is none.

5.8.5.10 PTZ

The PTZ interface is shown as in Figure 5-114 (Local) and Figure 5-115 (Remote).

Before setup, please check the following connections are right:

- PTZ and decoder connection is right. Decoder address setup is right.
- Decoder A (B) line connects with NVR A (B) line.

Click Save button after you complete setup, you can go back to the monitor interface to control speed dome.

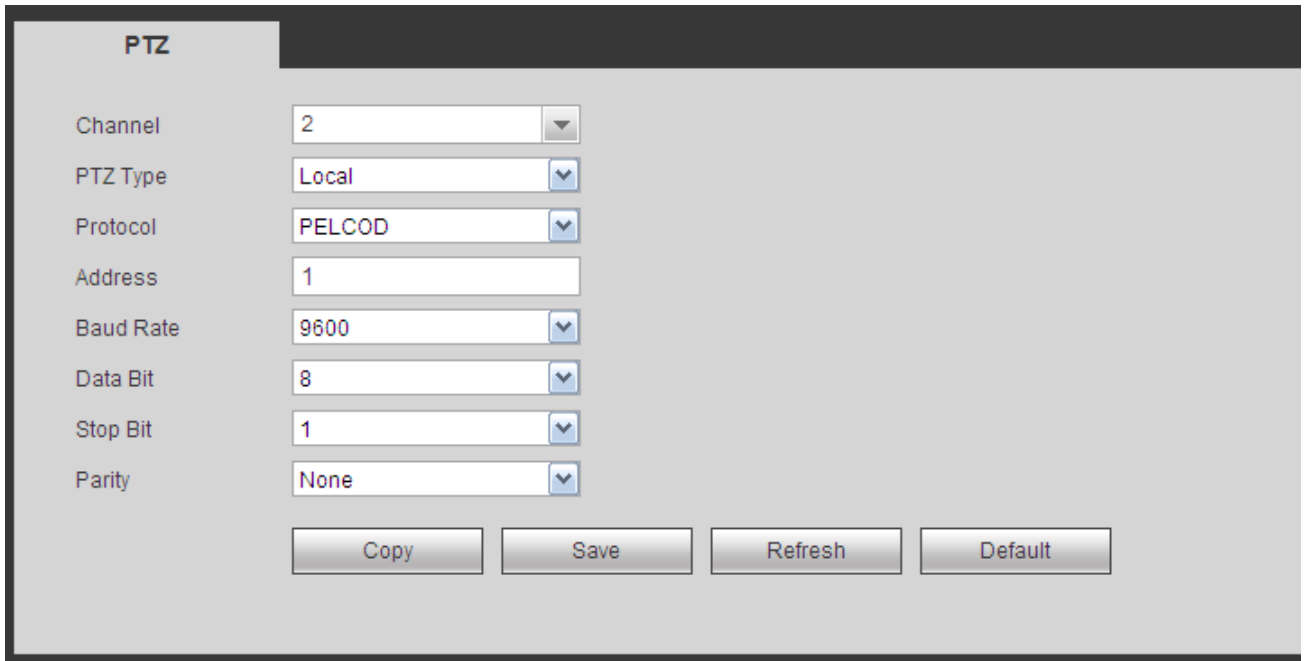

Figure 5-114

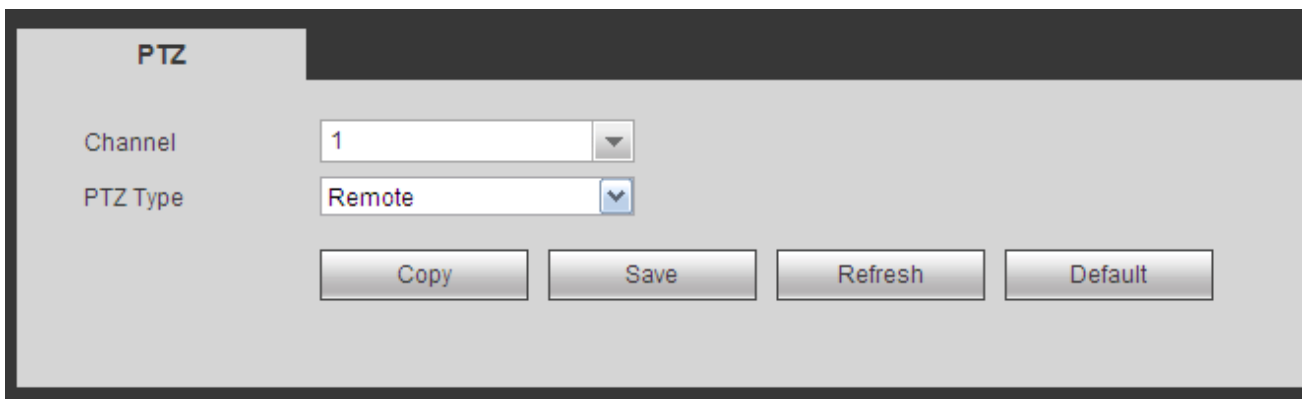

Figure 5-115

Please refer to the following sheet for detailed information.

Parameter	Function
Channel	Select speed dome connected channel.
PTZ Type	There are two options: local/remote. Please select remote type if you are connecting to the network PTZ. Please select local type if you are using RS485 to the PTZ camera.
Protocol	Select the corresponding dome protocol such as PELCOD.
Address	Set corresponding dome address. Default value is 1. Please note your setup here shall comply with your dome address; otherwise you can not control the speed dome.
Baud Rate	Select the dome baud rate. Default setup is 9600.
Data Bit	The value ranges from 5 to 8. Default setup is 8. Please set according to the speed dome dial switch setup.

Parameter	Function
Stop bit	The value ranges from 1 to 2. Default setup is 1. Please set according to the speed dome dial switch setup.
Parity	The options include non/odd/even/space/null. Default setup is none. Please set according to the speed dome dial switch setup.

5.9 Information

5.9.1 Version

The version interface is shown as in Figure 5-116.

Here you can view record channel, alarm input/output information, software version, release date and etc. Please note the following information is for reference only.

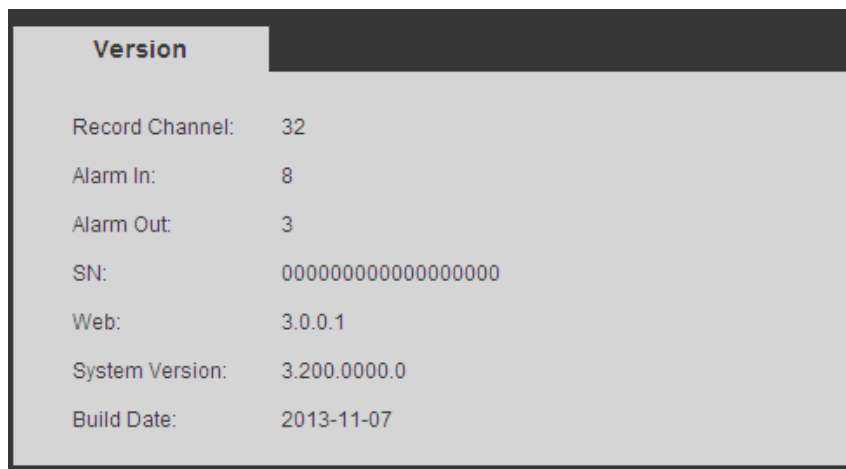

Figure 5-116

5.9.2 Log

Here you can view system log. See Figure 5-117.

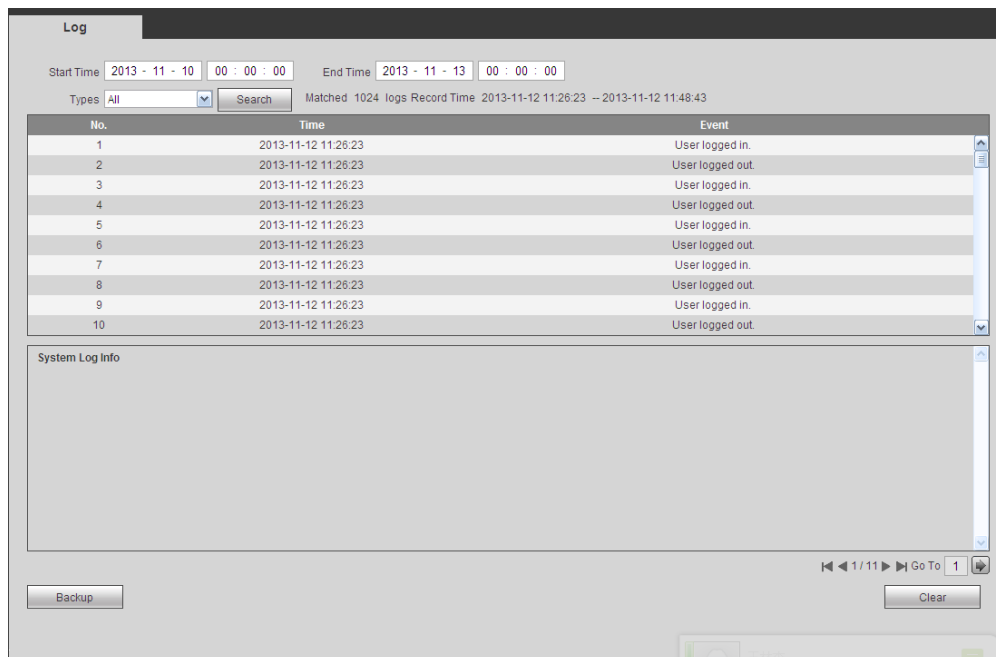

Figure 5-117

Please refer to the following sheet for log parameter information.

Parameter	Function
Type	Log types include: system operation, configuration operation, data operation, event operation, record operation, user management, log clear.
Start time	Set the start time of the requested log.
End time	Set the end time of the requested log.
Search	You can select log type from the drop down list and then click search button to view the list. You can click the stop button to terminate current search operation.
Detailed information	You can select one item to view the detailed information.
Clear	You can click this button to delete all displayed log files. Please note system does not support clear by type.
Backup	You can click this button to backup log files to current PC.

5.9.3 Online User

The online user interface is shown as in Figure 5-118.

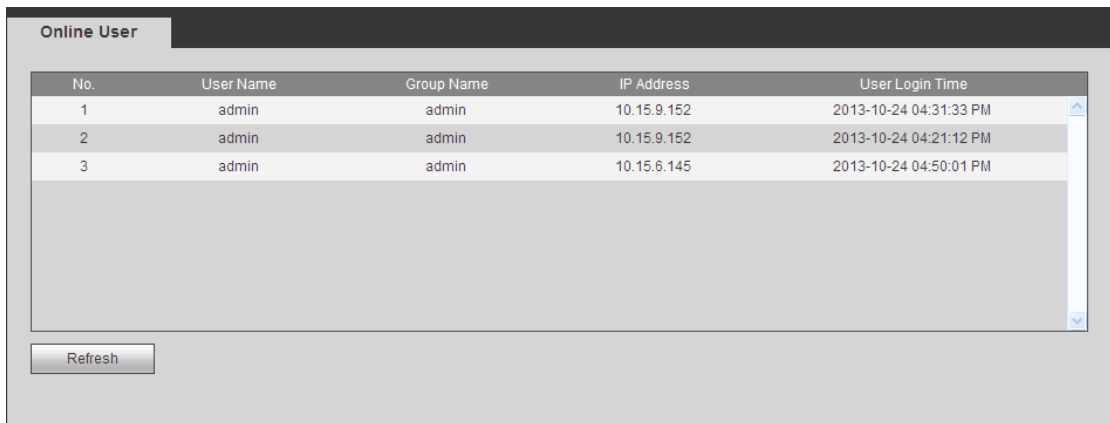

No.	User Name	Group Name	IP Address	User Login Time
1	admin	admin	10.15.9.152	2013-10-24 04:31:33 PM
2	admin	admin	10.15.9.152	2013-10-24 04:21:12 PM
3	admin	admin	10.15.6.145	2013-10-24 04:50:01 PM

Refresh

Figure 5-118

5.10 Playback

Click Playback button, you can see an interface is shown as in Figure 5-119.

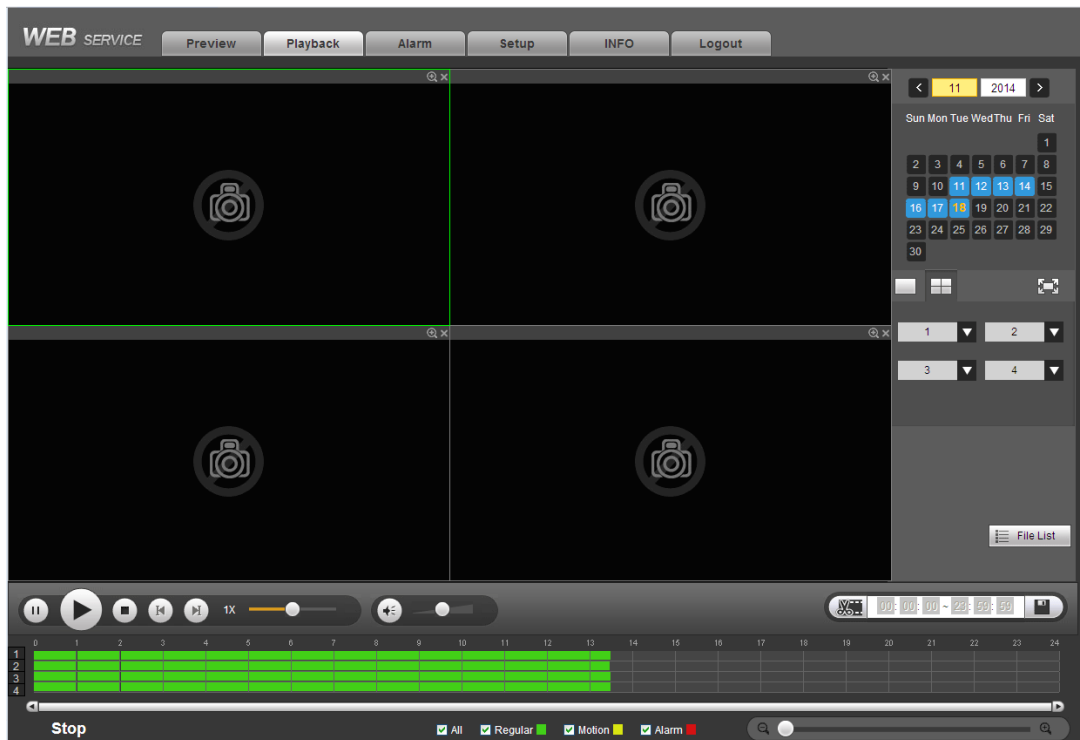

Figure 5-119

5.10.1 Search Record

Please set record type, record date, window display mode and channel name.

- Select Date

You can click the date on the right pane to select the date. The green highlighted date is system current date and the blue highlighted date means it has record files.

- Window Split

Select window split mode. Click  to display in full screen. Click ESC button to exit. See Figure 5-120.



Figure 5-120

- Select Channel

1~4 means main stream and A1~A4 means sub stream.

- Select Record Type

Check the corresponding box to select record type. See Figure 5-121.



Figure 5-121

5.10.2 File List

Click File list button, you can see the corresponding files in the list. See Figure 5-122.

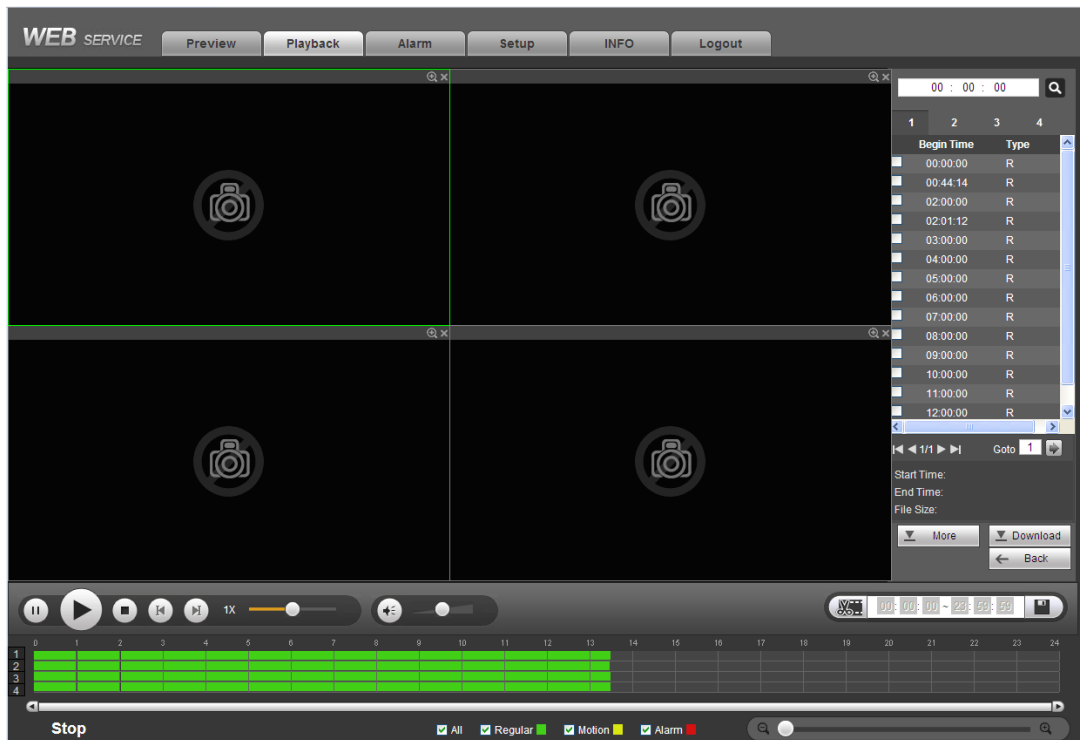

Figure 5-122

5.10.3 Playback

Select a file you want to play and then click Play button, system can begin playback. You can select to playback in full-screen. Please note for one channel, system can not playback and download at the same time. You can use the playback control bar to implement various operations such as play, pause, stop, slow play, fast play and etc. See Figure 5-123.

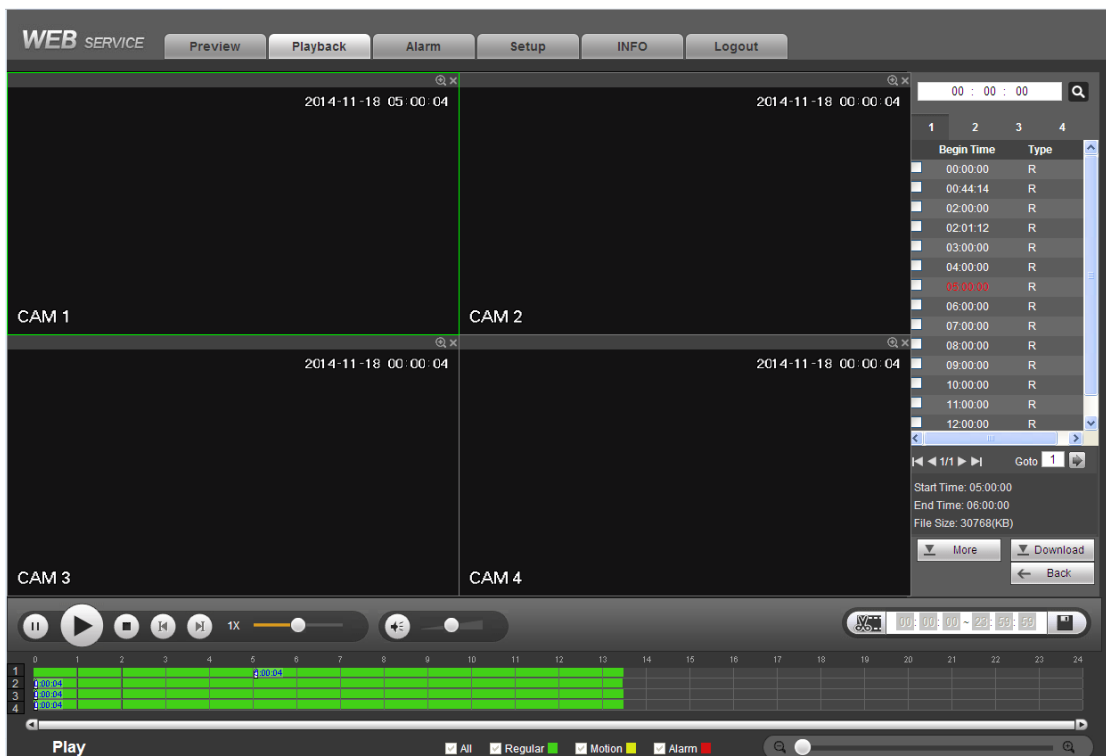

Figure 5-123

5.10.4 Download

Select the file(s) you want to download and then click download button, you can see an interface shown as in Figure 5-124. The Download button becomes Stop button and there is a process bar for your reference. Please go to you default file saved path to view the files.



Figure 5-124

5.10.5 Load more

It is for you to search record or picture. You can select record channel, record type and record time to download. Or you can use watermark function to verify file.

5.10.5.1 Download By File

Select channel, record type, bit stream type and then input start time and end time. Click Search button, the download by file interface is shown as in Figure 5-125.

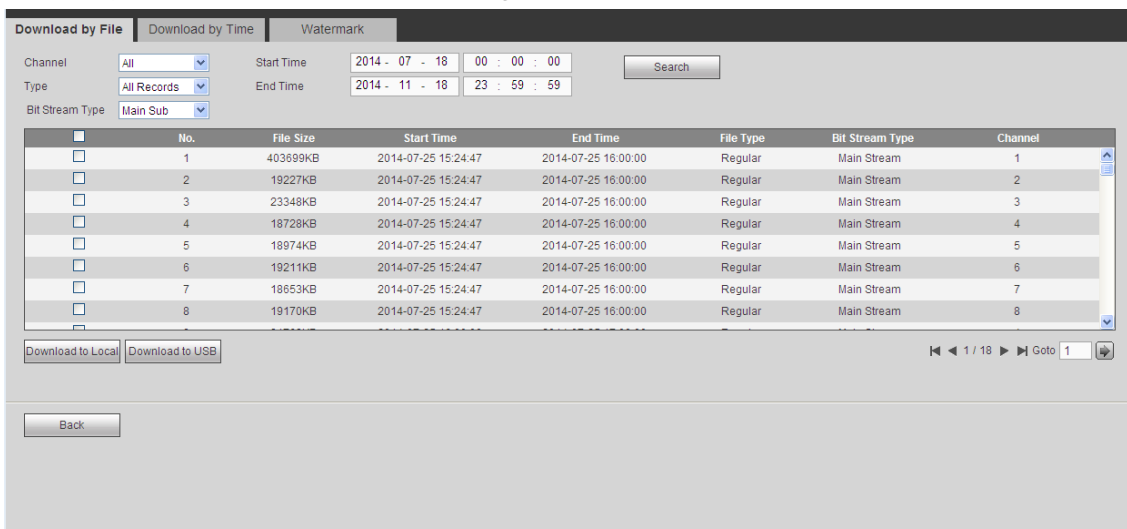

Figure 5-125

Check the file(s) you want to download and there are two options for you to save the file(s).

- Download to local

Click Download to local, system pops up the following interface for you to set record format and saved path. See Figure 5-126.

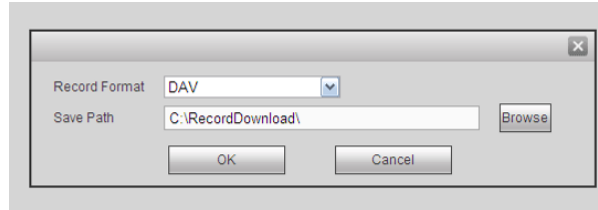

Figure 5-126

You can click OK to download and view the download process. After the download operation, you can see corresponding dialog box.

- Download to USB

Connect the corresponding peripheral device, and then click Download to USB button, you can see the following interface. See Figure 5-127.

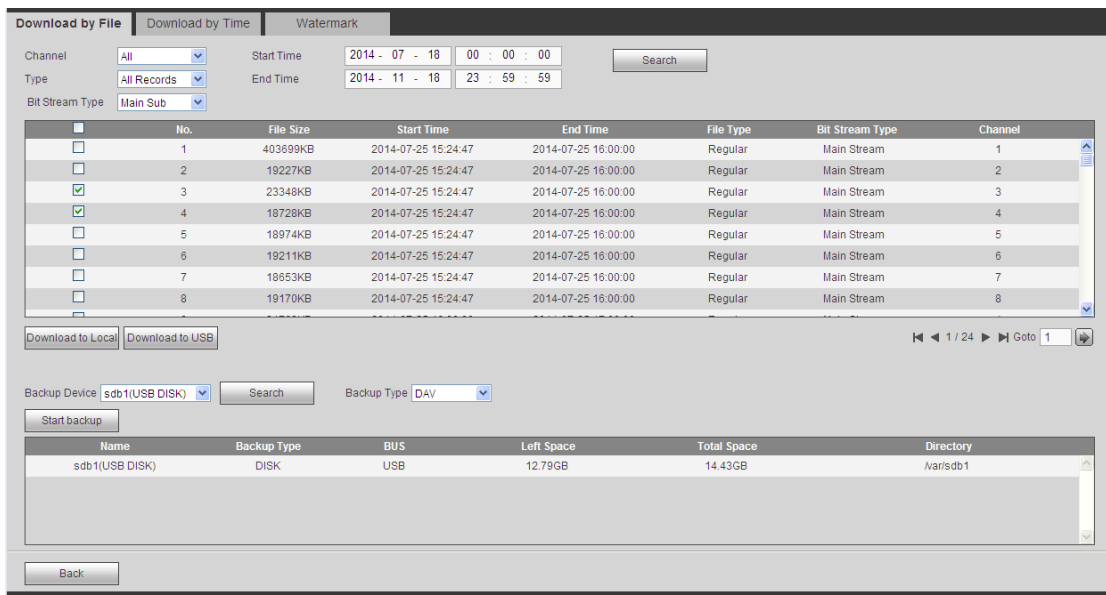

Figure 5-127

Select Backup device and backup type first and then click Start backup button.

After the download operation, you can see corresponding dialogue box.

5.10.5.2 Download by Time

Select channel, bit stream type, start time and end time.

Click Download to Local button, you can see download by time interface is shown as in Figure 5-128.

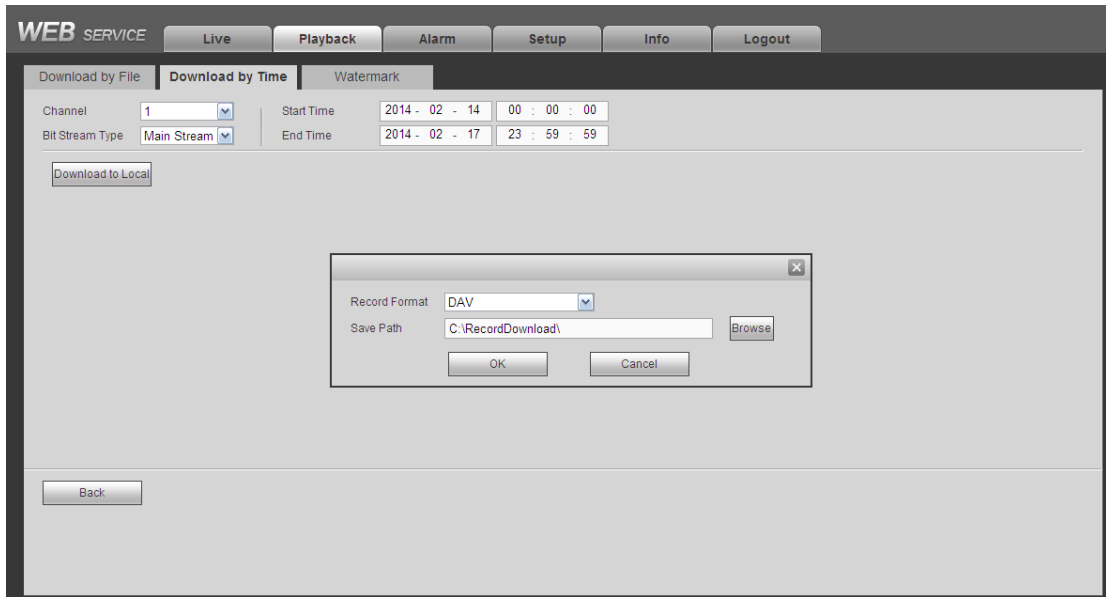

Figure 5-128

Set record format and saved path, you can click OK to download and view the download process. After the download operation, you can see corresponding dialog box.

5.10.5.3 Watermark

Watermark interface is shown as In Figure 5-129. Please select a file and then click Verify button to see the file has been tampered with or not

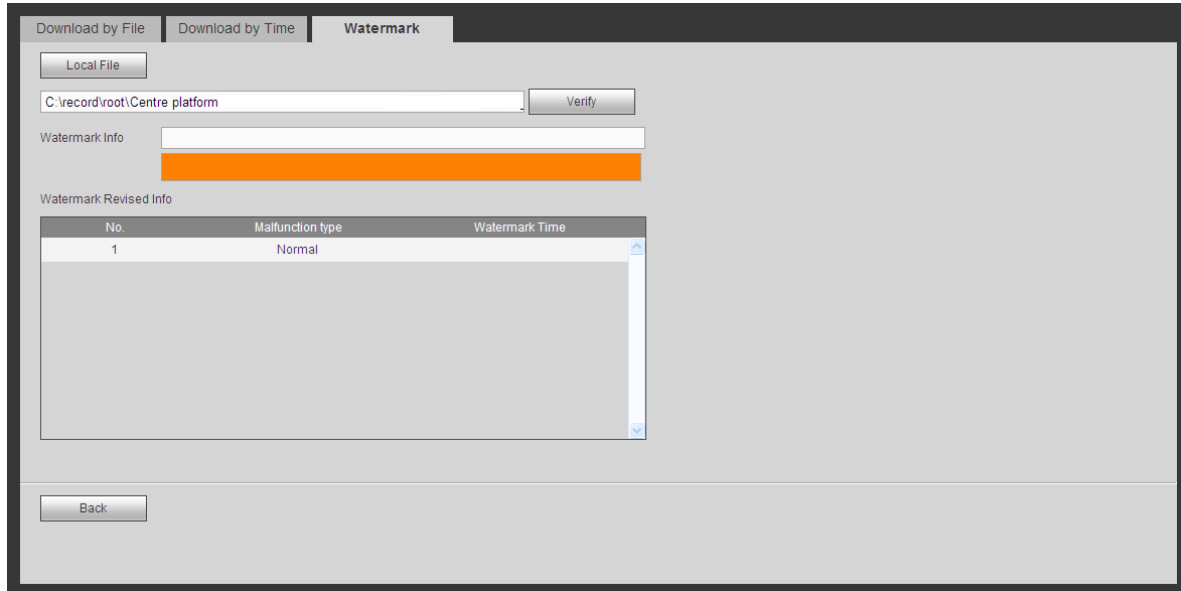

Figure 5-129

5.11 Alarm

Click alarm function, you can see an interface is shown as Figure 5-130.

Here you can set device alarm type and alarm sound setup (Please make sure you have enabled audio function of corresponding alarm events.).

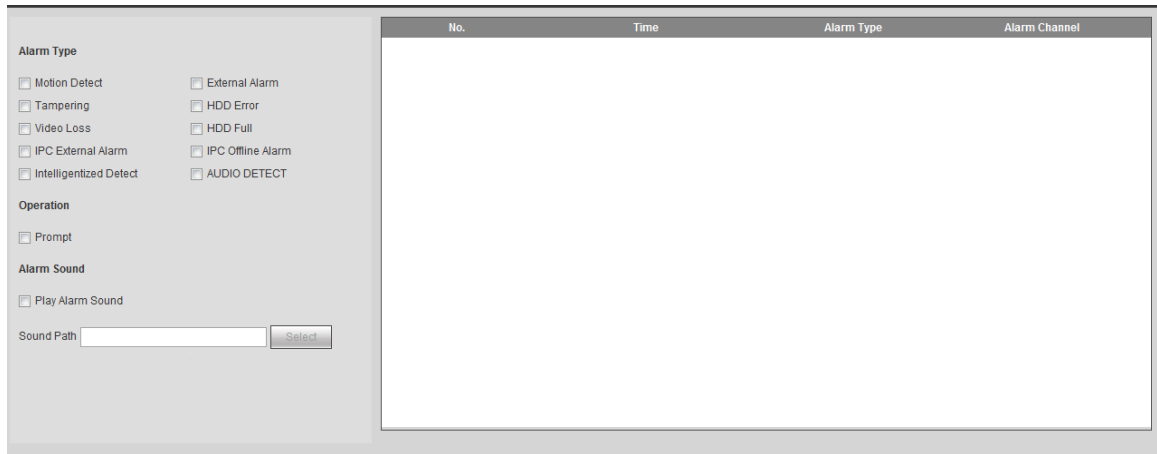

Figure 5-130

Please refer to the following sheet for detailed information.

Type	Parameter	Function
Alarm Type	Video loss	System alarms when video loss occurs.
	Motion detection	System alarms when motion detection alarm occurs.
	Tampering	System alarms when camera is viciously masking.
	Disk full	System alarms when disk is full.
	Disk error	System alarms when disk error occurs.
	External alarm	Alarm input device sends out alarm.
	IPC external alarm	It refers to the on-off signal from the network camera. It can activate the NVR local activation operation.
	IPC offline alarm	System can generate an alarm when the network camera and the NVR are disconnected.
	Intelligent detect	System alarms when IVS alarm occurs.
	Audio detect	System alarms when audio detect is abnormal.
Operation	Prompt	Check the box here, system can automatically pops up an alarm icon on the Alarm button in the main interface when there is an alarm.
Alarm Sound	Play alarm sound	System sends out alarm sound when an alarm occurs. You can specify as you wish.
	Sound path	Here you can specify alarm sound file.

5.12 Log out

Click log out button, system goes back to log in interface. See Figure 5-131.

You need to input user name and password to login again.

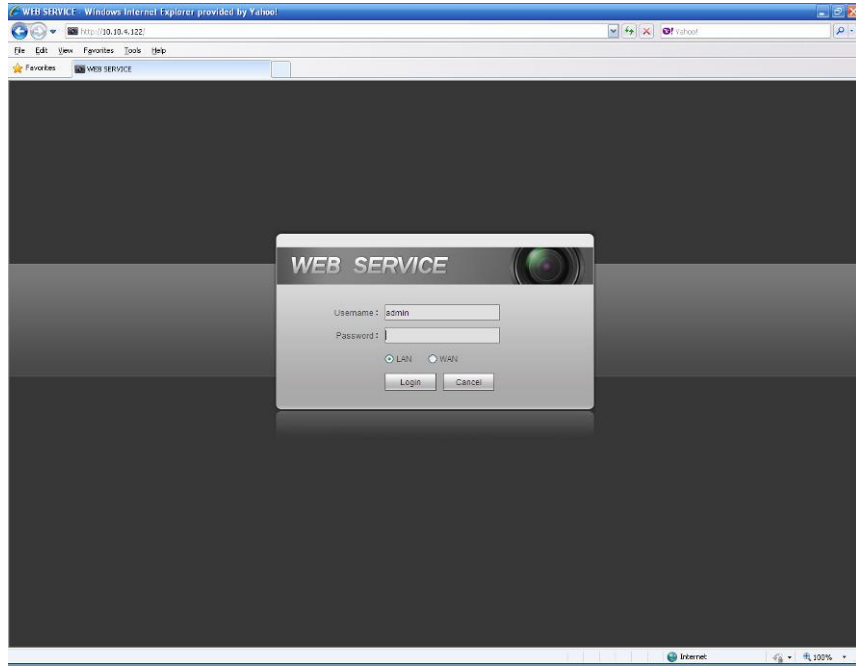

Figure 5-131

5.13 Un-install Web Control

You can use web un-install tool “uninstall web.bat” to un-install web control.

Please note, before you un-installation, please close all web pages, otherwise the un-installation might result in error

6 Glossary

- **DHCP:** DHCP (Dynamic Host Configuration Protocol) is a network protocol. It is one of the TCP/IP protocol cluster. It is principally used to assign temporary IP addresses to computers on a network.
- **DDNS:** DDNS (Dynamic Domain Name Server) is a service that maps Internet domain names to IP addresses. This service is useful to anyone who wants to operate a server (web server, mail server, ftp server and etc) connected to the internet with a dynamic IP or to someone who wants to connect to an office computer or server from a remote location with software.
- **eSATA:** eSATA(External Serial AT) is an interface that provides fast data transfer for external storage devices. It is the extension specifications of a SATA interface.
- **GPS:** GPS (Global Positioning System) is a satellite system, protected by the US military, safely orbiting thousands of kilometers above the earth.
- **PPPoE: PPPoE** (Point to Point Protocol over Ethernet) is a specification for connecting multiple computer users on an Ethernet local area network to a remote site. Now the popular mode is ADSL and it adopts PPPoE protocol.
- **WIFI:** Wi-Fi is the name of a popular wireless networking technology that uses radio waves to provide wireless high-speed Internet and network connections. The standard is for wireless local area networks (WLANs). It is like a common language that all the devices use to communicate to each other. It is actually IEEE802.11, a family of standard The IEEE (Institute of Electrical and Electronics Engineers Inc.)
- **3G:** 3G is the wireless network standard. It is called 3G because it is the third generation of cellular telecom standards. 3G is a faster network for phone and data transmission and speed is over several hundred kbps. Now there are four standards: CDMA2000, WCDMA, TD-SCDMA and WiMAX.
- **Dual-stream:** The dual-stream technology adopts high-rate bit stream for local HD storage such as QCIF/CIF/2CIF/DCIF/4CIF encode and one low-rate bit stream for network transmission such as QCIF/CIF encode. It can balance the local storage and remote network transmission. The dual-stream can meet the difference band width requirements of the local transmission and the remote transmission. In this way, the local transmission using high-bit stream can achieve HD storage and the network transmission adopting low bit stream suitable for the fluency requirements of the 3G network such as WCDMA, EVDO, TD-SCDMA..
- **On-off value:** It is the non-consecutive signal sampling and output. It includes remote sampling and remote output. It has two statuses: 1/0.

7 FAQ

Questions	Solutions
<p>NVR can not boot up properly.</p>	<ul style="list-style-type: none"> ● Input power is not correct. ● Power connection is not correct. ● Power switch button is damaged. ● Program upgrade is wrong. ● HDD malfunction or something wrong with HDD ribbon. ● Seagate DB35.1, DB35.2, SV35 or Maxtor 17-g has compatibility problem. Please upgrade to the latest version to solve this problem. ● Front panel error. ● Main board is damaged.
<p>NVR often automatically shuts down or stops running.</p>	<ul style="list-style-type: none"> ● Input voltage is not stable or it is too low. ● HDD malfunction or something wrong with the ribbon. ● Button power is not enough. ● Front video signal is not stable. ● Working environment is too harsh, too much dust. ● Hardware malfunction.
<p>System can not detect hard disk.</p>	<ul style="list-style-type: none"> ● HDD is broken. ● HDD ribbon is damaged. ● HDD cable connection is loose. ● Main board SATA port is broken.
<p>There is no video output whether it is one-channel, multiple-channel or all-channel output.</p>	<ul style="list-style-type: none"> ● Program is not compatible. Please upgrade to the latest version. ● Brightness is 0. Please restore factory default setup. ● Check your screen saver. ● NVR hardware malfunctions.
<p>I can not search local records.</p>	<ul style="list-style-type: none"> ● HDD ribbon is damaged. ● HDD is broken. ● Upgraded program is not compatible. ● The recorded file has been overwritten. ● Record function has been disabled.
<p>Video is distorted when searching local records.</p>	<ul style="list-style-type: none"> ● Video quality setup is too low. ● Program read error, bit data is too small. There is mosaic in the full screen. Please restart the NVR to solve this problem. ● HDD data ribbon error. ● HDD malfunction. ● NVR hardware malfunctions.
<p>Time display is not correct.</p>	<ul style="list-style-type: none"> ● Setup is not correct ● Battery contact is not correct or voltage is too low. ● Crystal is broken.

Questions	Solutions
<p>NVR can not control PTZ.</p>	<ul style="list-style-type: none"> ● Front panel PTZ error ● PTZ decoder setup, connection or installation is not correct. ● Cable connection is not correct. ● PTZ setup is not correct. ● PTZ decoder and NVR protocol is not compatible. ● PTZ decoder and NVR address is not compatible. ● When there are several decoders, please add 120 Ohm between the PTZ decoder A/B cables furthest end to delete the reverberation or impedance matching. Otherwise the PTZ control is not stable. ● The distance is too far.
<p>I can not log in client-end or web.</p>	<ul style="list-style-type: none"> ● For Windows 98 or Windows ME user, please update your system to Windows 2000 sp4. Or you can install client-end software of lower version. Please note right now, our NVR is not compatible with Windows VISTA control. ● ActiveX control has been disabled. ● No dx8.1 or higher. Please upgrade display card driver. ● Network connection error. ● Network setup error. ● Password or user name is invalid. ● Client-end is not compatible with NVR program.
<p>There is only mosaic no video when preview or playback video file remotely.</p>	<ul style="list-style-type: none"> ● Network fluency is not good. ● Client-end resources are limit. ● Current user has no right to monitor.
<p>Network connection is not stable.</p>	<ul style="list-style-type: none"> ● Network is not stable. ● IP address conflict. ● MAC address conflict. ● PC or device network card is not good.
<p>Burn error /USB back error.</p>	<ul style="list-style-type: none"> ● Burner and NVR are in the same data cable. ● System uses too much CPU resources. Please stop record first and then begin backup. ● Data amount exceeds backup device capacity. It may result in burner error. ● Backup device is not compatible. ● Backup device is damaged.
<p>Keyboard can not control NVR.</p>	<ul style="list-style-type: none"> ● NVR serial port setup is not correct ● Address is not correct ● When there are several switchers, power supply is not enough. ● Transmission distance is too far.

Questions	Solutions
Alarm signal can not be disarmed.	<ul style="list-style-type: none"> ● Alarm setup is not correct. ● Alarm output has been open manually. ● Input device error or connection is not correct. ● Some program versions may have this problem. Please upgrade your system.
Alarm function is null.	<ul style="list-style-type: none"> ● Alarm setup is not correct. ● Alarm cable connection is not correct. ● Alarm input signal is not correct. ● There are two loops connect to one alarm device.
Record storage period is not enough.	<ul style="list-style-type: none"> ● Camera quality is too low. Lens is dirty. Camera is installed against the light. Camera aperture setup is not correct. ● HDD capacity is not enough. ● HDD is damaged.
Can not playback the downloaded file.	<ul style="list-style-type: none"> ● There is no media player. ● No DXB8.1 or higher graphic acceleration software. ● There is no DivX503Bundle.exe control when you play the file transformed to AVI via media player. ● No DivX503Bundle.exe or ffdshow-2004 1012 .exe in Windows XP OS.
Forgot local menu operation password or network password	<ul style="list-style-type: none"> ● Please contact your local service engineer or our sales person for help. We can guide you to solve this problem.
There is no video. The screen is in black.	<ul style="list-style-type: none"> ● IPC IP address is not right. ● IPC port number is not right. ● IPC account (user name/password) is not right. ● IPC is offline.
The displayed video is not full in the monitor.	Please check current resolution setup. If the current setup is 1920*1080, then you need to set the monitor resolution as 1920*1080.
There is no HDMI output.	<ul style="list-style-type: none"> ● Displayer is not in HDMI mode. ● HDMI cable connection is not right.
The video is not fluent when I view in multiple-channel mode from the client-end.	<ul style="list-style-type: none"> ● The network bandwidth is not sufficient. The multiple-channel monitor operation needs at least 100M or higher. ● Your PC resources are not sufficient. For 16-ch remote monitor operation, the PC shall have the following environment: Quad Core, 2G or higher memory, independent displayer, display card memory 256M or higher.

Questions	Solutions
<p>I can not connect to the IPC</p>	<ul style="list-style-type: none"> ● Please make sure the IPC has booted up. ● IPC network connection is right and it is online ● IPC IP is in the blacklist. ● The device has connected to the too many IPC. It can not transmit the video. ● Check the IPC port value and the time zone is the same as the NVR. ● Make sure current network environment is stable.
<p>After I set the NVR resolution as 1080P, my monitor can not display.</p>	<p>Shut down the device and then reboot. When you reboot, please press the Fn button at the same time and then release after 5 seconds. You can restore NVR resolution to the default setup.</p>
<p>My admin account has been changed and I can not log in.</p>	<p>Use telnet and then input the following command:</p> <pre>cd /mnt/mtd/Config/ rm -rf group rm -rf password</pre> <p>Reboot the device to restore the default password.</p>
<p>After I login the Web , I can not find the remote interface to add the IPC.</p>	<p>Please clear the Web controls and load again.</p>
<p>There is IP and gateway, I can access the internet via the router. But I can not access the internet after I reboot the NVR.</p>	<p>Please use command PING to check you can connect to the gateway or not. Use telnet to access and then use command “ifconfig –a” to check device IP address. If you see the subnet mask and the gateway has changed after the reboot. Please upgrade the applications and set again.</p>
<p>I use the VGA montior.I want to know if I use the multiple-window mode, I see the video from the main stream or the sub stream?</p>	<ul style="list-style-type: none"> ● For 32-channel series product, the 9/16-window is using the sub stream. ● For 4/8/16 series product, system is using the main stream no matter you are in what display mode.

Daily Maintenance

- Please use the brush to clean the board, socket connector and the chassis regularly.
- The device shall be soundly earthed in case there is audio/video disturbance. Keep the device away from the static voltage or induced voltage.
- Please unplug the power cable before you remove the audio/video signal cable, RS232 or RS485 cable.
- Do not connect the TV to the local video output port (VOUT).It may result in video output circuit.
- Always shut down the device properly. Please use the shutdown function in the menu, or you can press the power button in the rear pane for at least three seconds to shut down the device.



Otherwise it may result in HDD malfunction.

- Please make sure the device is away from the direct sunlight or other heating sources. Please keep the sound ventilation.
- Please check and maintain the device regularly.

8 Appendix A HDD Capacity Calculation

Calculate total capacity needed by each device according to video recording (video recording type and video file storage time).

Step 1: According to Formula (1) to calculate storage capacity q_i that is the capacity of each channel needed for each hour, unit Mbyte.

$$q_i = d_i \div 8 \times 3600 \div 1024 \quad (1)$$

In the formula: d_i means the bit rate, unit Kbit/s

Step 2: After video time requirement is confirmed, according to Formula (2) to calculate the storage capacity m_i , which is storage of each channel needed unit Mbyte.

$$m_i = q_i \times h_i \times D_i \quad (2)$$

In the formula:

h_i means the recording time for each day (hour)

D_i means number of days for which the video shall be kept

Step 3: According to Formula (3) to calculate total capacity (accumulation) q_T that is needed for all channels in the device during **scheduled video recording**.

$$q_T = \sum_{i=1}^c m_i \quad (3)$$

In the formula: c means total number of channels in one device

Step 4: According to Formula (4) to calculate total capacity (accumulation) q_T that is needed for all channels in device during **alarm video recording (including motion detection)**.

$$q_T = \sum_{i=1}^c m_i \times a\% \quad (4)$$

In the formula: $a\%$ means alarm occurrence rate

9 Appendix B Compatible Network Camera List

Please note all the models in the following list for reference only. For those products not included in the list, please contact your local retailer or technical supporting engineer for detailed information.

Manufacture	Model	Version	Video Encode	Audio/Video	Protocol
AXIS	P1346	5.40.9.2	H264	√	ONVIF/Private
	P3344/P3344-E	5.40.9.2	H264	√	ONVIF/Private
	P5512	—	H264	√	ONVIF/Private
	Q1604	5.40.3.2	H264	√	ONVIF/Private
	Q1604-E	5.40.9	H264	√	ONVIF/Private
	Q6034E	—	H264	√	ONVIF/Private
	Q6035	5.40.9	H264	√	ONVIF/Private
	Q1755	—	H264	√	ONVIF/Private
	M7001	—	H264	√	Private
	M3204	5.40.9.2	H264	√	Private
	P3367	HEAD LFP4_0 130220	H264	√	ONVIF
	P5532-P	HEAD LFP4_0 130220	H264	√	ONVIF
ACTi	ACM-3511	A1D-220-V3.12 .15-AC	MPEG4	√	Private
	ACM-8221	A1D-220-V3.13 .16-AC	MPEG4	√	Private
Arecont	AV1115	65246	H264	√	Private
	AV10005DN	65197	H264	√	Private
	AV2115DN	65246	H264	√	Private
	AV2515DN	65199	H264	√	Private
	AV2815	65197	H264	√	Private
	AV5115DN	65246	H264	√	Private
	AV8185DN	65197	H264	√	Private
Bosch	NBN-921-P	—	H264	√	ONVIF
	NBC-455-12P	—	H264	√	ONVIF
	VG5-825	9500453	H264	√	ONVIF
	NBN-832	66500500	H264	√	ONVIF
	VEZ-211-IWT EIVA	—	H264	√	ONVIF
	NBC-255-P	15500152	H264	√	ONVIF
	VIP-X1XF	—	H264	√	ONVIF
Brikcom	B0100	—	H264	√	ONVIF
	D100	—	H264	√	ONVIF
	GE-100-CB	—	H264	√	ONVIF
	FB-100A	v1.0.3.9	H264	√	ONVIF
	FD-100A	v1.0.3.3	H264	√	ONVIF

Manufacture	Model	Version	Video Encode	Audio/Video	Protocol
Cannon	VB-M400	—	H264	√	Private
CNB	MPix2.0DIR	XNETM1120111229	H264	√	ONVIF
	VIPBL1.3MIRVF	XNETM2100111229	H264	√	ONVIF
	IGC-2050F	XNETM2100111229	H264	√	ONVIF
CP PLUS	CP-NC9-K	6.E.2.7776	H264	√	ONVIF/Private
	CP-NC9W-K	6.E.2.7776	H264	√	Private
	CP-ND10-R	cp20111129ANS	H264	√	ONVIF
	CP-ND20-R	cp20111129ANS	H264	√	ONVIF
	CP-NS12W-CR	cp20110808NS	H264	√	ONVIF
	VS201	cp20111129NS	H264	√	ONVIF
	CP-NB20-R	cp20110808BNS	H264	√	ONVIF
	CP-NT20VL3-R	cp20110808BNS	H264	√	ONVIF
	CP-NS36W-AR	cp20110808NS	H264	√	ONVIF
	CP-ND20VL2-R	cp20110808BNS	H264	√	ONVIF
	CP-RNP-1820A	cp20120821NSA	H264	√	Private
	CP-RNC-TP20FL3C	cp20120821NSA	H264	√	Private
	CP-RNP-12DS	cp20120828ANS	H264	√	Private
	CP-RNC-DV10	cp20120821NSA	H264	√	Private
	CP-RNC-DP20FL2C	cp20120821NSA	H264	√	Private
Dynacolor	ICS-13	d20120214NS	H264	√	ONVIF/Private
	ICS-20W	vt20111123NSA	H264	√	ONVIF/Private
	NA222	—	H264	√	ONVIF
	MPC-IPVD-0313	k20111208ANS	H264	√	ONVIF/Private
	MPC-IPVD-0313AF	k20111208BNS	H264	√	ONVIF/Private
Honeywell	HIDC-1100PT	h.2.2.1824	H264	√	ONVIF
	HIDC-1100P	h.2.2.1824	H264	√	ONVIF

Manufacture	Model	Version	Video Encode	Audio/Video	Protocol
	HIDC-0100P	h.2.2.1824	H264	√	ONVIF
	HIDC-1300V	2.0.0.21	H264	√	ONVIF
	HICC-1300W	2.0.1.7	H264	√	ONVIF
	HICC-2300	2.0.0.21	H264	√	ONVIF
	HDZ20HDX	H20130114NS A	H264	√	ONVIF
LG	LW342-FP	—	H264	√	Private
	LNB5100	—	H264	√	ONVIF
Imatek	KNC-B5000	—	H264	√	Private
	KNC-B5162	—	H264	√	Private
	KNC-B2161	—	H264	√	Private
Panasonic	NP240/CH	—	MPEG4	√	Private
	WV-NP502	—	MPEG4	√	Private
	WV-SP102H	1.41	H264	√	ONVIF/Private
	WV-SP105H	—	H264	√	ONVIF/Private
	WV-SP302H	1.41	H264、MPEG4	√	ONVIF/Private
	WV-SP306H	1.4	H264、MPEG4	√	ONVIF/Private
	WV-SP508H	—	H264、MPEG4	√	ONVIF/Private
	WV-SP509H	—	H264、MPEG4	√	ONVIF/Private
	WV-SF332H	1.41	H264、MPEG4	√	ONVIF/Private
	WV-SW316H	1.41	H264、MPEG4	√	ONVIF/Private
	WV-SW355H	1.41	H264、MPEG4	√	ONVIF/Private
	WV-SW352H	—	H264、MPEG4	√	ONVIF/Private
	WV-SW152E	1.03	H264、MPEG4	√	ONVIF/Private
	WV-SW558H	—	H264、MPEG4	√	ONVIF/Private
	WV-SW559H	—	H264、MPEG4	√	ONVIF/Private
	WV-SP105H	1.03	H264、MPEG4	√	ONVIF/Private
	WV-SW155E	1.03	H264、MPEG4	√	ONVIF/Private
	WV-SF336H	1.44	H264、MPEG4	√	ONVIF/Private
	WV-SF332H	1.41	H264、MPEG4	√	ONVIF/Private
	WV-SF132E	1.03	H264、MPEG4	√	ONVIF/Private
	WV-SF135E	1.03	H264、MPEG4	√	ONVIF/Private
	WV-SF346H	1.41	H264、MPEG4	√	ONVIF/Private
	WV-SF342H	1.41	H264、MPEG4	√	ONVIF/Private
	WV-SC385H	1.08	H264、MPEG4	√	ONVIF/Private
	WV-SC386H	1.08	H264、MPEG4	√	ONVIF/Private
	WV-SP539	1.66	H264、MPEG4	√	ONVIF
DG-SC385	1.66	H264、MPEG4	√	ONVIF	
PELCO	IXSOLW	1.8.1-20110912 -1.9082-A1.661 7	H264	√	Private
	IDE20DN	1.7.41.9111-O3 .6725	H264	√	Private

Manufacture	Model	Version	Video Encode	Audio/Video	Protocol
	D5118	1.7.8.9310-A1.5288	H264	√	Private
	IM10C10	1.6.13.9261-O2.4657	H264	√	Private
	DD4N-X	01.02.0015	MPEG4	√	Private
	DD423-X	01.02.0006	MPEG4	√	Private
	D5220	1.8.3-FC2-20120614-1.9320-A1.8035	H264	√	Private
Samsung	SNB-3000P	2.41	H264、MPEG4	√	ONVIF/Private
	SNP-3120	1.22_110120_1	H264、MPEG4	√	ONVIF/Private
	SNP-3370	1.21_110318	MPEG4	√	Private
	SNB-5000	2.10_111227	H264、MPEG4	√	ONVIF/Private
	SND-5080	—	H264、MPEG4	√	Private
	SNZ-5200	1.02_110512	H264、MPEG4	√	ONVIF/Private
	SNP-5200	1.04_110825	H264、MPEG4	√	ONVIF/Private
	SNB-7000	1.10_110819	H264	√	ONVIF/Private
	SNB-6004	V1.0.0	H264	√	ONVIF
Sony	SNC-DH110	1.50.00	H264	√	ONVIF/Private
	SNC-CH120	1.50.00	H264	√	ONVIF/Private
	SNC-CH135	1.73.01	H264	√	ONVIF/Private
	SNC-CH140	1.50.00	H264	√	ONVIF/Private
	SNC-CH210	1.73.00	H264	√	ONVIF/Private
	SNC-DH210	1.73.00	H264	√	ONVIF/Private
	SNC-DH240	1.50.00	H264	√	ONVIF/Private
	SNC-DH240-T	1.73.01	H264	√	ONVIF/Private
	SNC-CH260	1.74.01	H264	√	ONVIF/Private
	SNC-CH280	1.73.01	H264	√	ONVIF/Private
	SNC-RH-124	1.73.00	H264	√	ONVIF/Private
	SNC-RS46P	1.73.00	H264	√	ONVIF/Private
	SNC-ER550	1.74.01	H264	√	ONVIF/Private
	SNC-ER580	1.74.01	H264	√	ONVIF/Private
	SNC-ER580	1.78.00	H264	√	ONVIF
	SNC-VM631	1.4.0	H264	√	ONVIF
	WV-SP306	1.61.00	H264、MPEG4	√	SDK
	WV-SP306	1.61.00	H264	√	ONVIF
	SNC-VB600	1.5.0	H264	√	Private
	SNC-VM600	1.5.0	H264	√	Private
SNC-VB630	1.5.0	H264	√	Private	
SNC-VM630	1.5.0	H264	√	Private	
SANYO	VCC-HDN4000PC	—	H264	√	ONVIF

Note

- **This manual is for reference only. Slight difference may be found in the user interface.**
- **All the designs and software here are subject to change without prior written notice.**
- **All trademarks and registered trademarks are the properties of their respective owners.**
- **If there is any uncertainty or controversy, please refer to the final explanation of us.**
- **Please visit our website or contact your local service engineer for more information.**

ZHEJIANG DAHUA VISION TECHNOLOGY CO.,LTD.

Address: No.1199, Bin'an Road, Binjiang District, Hangzhou, P.R. China

Postcode: 310053

Tel: +86-571-87688883

Fax: +86-571-87688815

Email:overseas@dahuatech.com

Website: www.dahuatech.com